



RE GRUP ENDÜSTRİYEL ÜRÜNLER SANAYİ VE
DIŞ TİCARET LİMİTED ŞİRKETİ

2024 - 2025

PROFİL KATALOĞU
PROFILE CATALOG

www.regrup.net

STANDART PROFİLLER	<i>STANDARD PROFILES</i>	3
SERAMİK CEPHE PROFİLLERİ	<i>CERAMIC FACEDE PROFILES</i>	8
GİYDİRME CEPHE PROFİLLERİ	<i>CURTAIN WALL PROFILES</i>	20
C60 PROFİLLERİ	<i>C-60 PROFILES</i>	26
ALDOKS PROFİLLERİ	<i>ALDOKS PROFILES</i>	32
TUBA SERİSİ PROFİLLERİ	<i>TUBA SERIES PROFILES</i>	36
CAM BALKON PROFİLLERİ	<i>GLASS BALCONY PROFILES</i>	39
CAM BALKON PROFİLLERİ - SÜRME SERİSİ	<i>GLASS BALCONY PROFILES</i>	44
PANJUR ve KEPENK PROFİLLERİ	<i>BLINDS and SHUTTERS PROFILES</i>	48
SİNEKLİK PROFİLLERİ	<i>INSECT SCREEN PROFILES</i>	56
KÜPEŞTE ve KORKULUK PROFİLLERİ	<i>HANDRAIL and RAILING PROFILES</i>	65
KARE KÜPEŞTE PROFİLLERİ	<i>SQUARE HANDRAIL PROFILES</i>	68
HAREKETLİ KÜPEŞTE PROFİLLERİ	<i>MOVABLE HANDRAİL PROFILES</i>	73
PERGOLA PROFİL SİSTEMLERİ	<i>PERGOLA PROFILE SYSTEMS</i>	82
TENTE PROFİL SİSTEMLERİ	<i>AWNING PROFILE SYSTEMS</i>	102
KIŞ BAHÇESİ PROFİLLERİ	<i>WINTER GARDEN PROFILES</i>	115
BİOKLİMATİK PROFİL SİSTEMLERİ	<i>BIOCLIMATIC PROFILES SYSTEMS</i>	121
ROLLING PROFİL SİSTEMLERİ	<i>ROLLING ROOF PROFILES SYSTEMS</i>	131
ZİP PERDE PROFİLLERİ	<i>ZIP CURTAIN PROFILES</i>	137
HERMETİK KAPI SÜRME ve OTOMATİK KAPI PROFİLLERİ		
<i>HANDRAIL and RAILING PROFILES</i>		142
OTOMOTİV PROFİLLERİ	<i>AUTOMOTIVE PROFILES</i>	147
SOĞUTMA PROFİLLERİ	<i>COOLING PROFILES</i>	154
MOBİLYA PROFİLLER	<i>FURNITURE PROFILES</i>	167
MENFEZ PROFİLLERİ	<i>CULVERT PROFILES</i>	170
RAF PROFİLLERİ	<i>SHELF PROFILES</i>	175
DENİZLİK PROFİLLERİ	<i>SILL PROFILES</i>	177
DİLATASYON PROFİLLERİ	<i>DILATATION PROFILES</i>	183
ŞEMSIYE PROFİLLERİ	<i>UMBRELLA PROFILES</i>	221



STANDART PROFILLER

STANDARD PROFILES

www.regrup.net

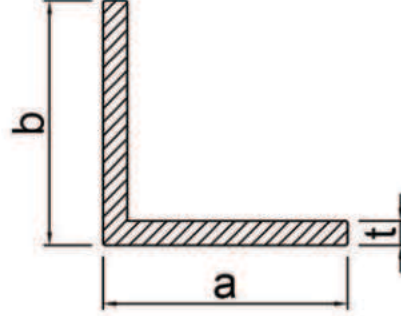

PROFIL NO	a	b	t
3004	20	20	1,5
3031	20	30	1,2
3006	20	40	1
3010	20	50	2
3024	20	60	1,4
3025	20	80	1,4
3026	20	100	1,4
1642*	25	50	2,0
3007	30	30	1,0
3030	30	30	2,0
3027*	30	30	1,8
3011	30	40	2,0
3012	30	50	2
3005	30	50	2
3009	40	40	4
3033	40	50	2
3032	50	50	1,2
3008	50	50	4

PROFIL NO	a	b	t
3019	50	50	2
1641*	50	50	2
3028	50	60	4
3018	50	70	3,2
3013	50	80	3,2
3029	50	80	4,0
3014	50	100	3,2
3021	50	100	4
3015	50	120	3,2
3022	50	120	4,0
3016	50	130	3,2
3036	50	150	2,0
3017	50	150	3,2
3023	50	150	4,0
1608	50	25	1,7

(*profile with serrated surface)

(*tırtıklı profil yüzeyi)

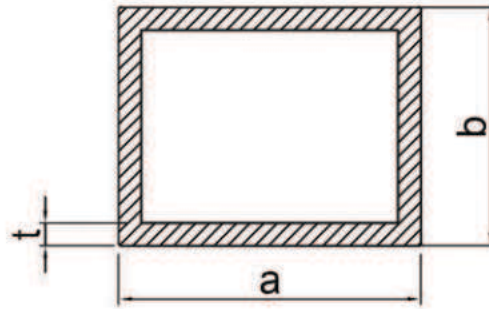

PROFİL NO	a	b	t
3331	10	10	1,2
3307	10	20	1,5
3345-1	14	33	1,3
3335	15	15	0,9
3330	17	25	1,5
3345	14	44	1,3
3309	20	20	1,5
3310	20	30	1,5
3314	20	40	1,5
3306	20	40	1,5
3320	20	40	2,0
3354	20	50	2,0
3336	20	60	1,2
3351	20	60	2,0
3328	20	80	1,2
3311	25	25	1,5
3334	25	105	1,5
3308	30	30	1,5
3332	30	30	3,0
3326	30	40	2,0
3346	30	40	3,0
3348	30	50	2,0
3347	30	60	1,5
3339	30	100	1,6
3340	30	150	1,8

PROFİL NO	a	b	t
3313	32	75	1,2
3305	40	40	1,5
3324	40	40	2,0
3324-1	40	40	3,0
3312	40	50	1,2
3327	40	50	2,0
3325	40	60	1,0
3338	40	60	1,5
3355	40	60	2,0
3323	40	80	1,4
3349	40	80	2,0
3319	47	87	2,0
3321	50	50	2,0
3316	50	95	1,5
3315	50	100	1,5
3337	50	100	2,0
3356	50	100	3,0
3317	50	150	1,8
3341	50	200	2,5
3353	60	80	1,5
3322	60	120	1,6
3329	80	80	1,5
3357	93	93	2,0
3318	100	100	1,8
3358	100	100	3,0
3359	100	100	4,0
3342	100	150	2,0
3343	100	200	3,0
3344	150	150	3,0

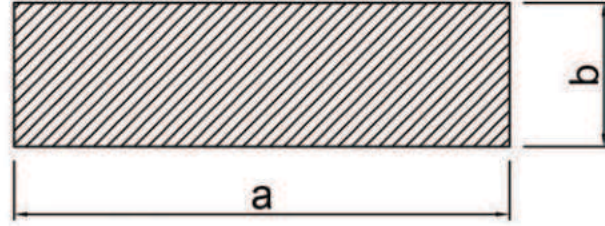

PROFİL NO	a	b
556	85	4
3801	15	5
3802	15	3
3803	10	5
3804	10	3
3805	40	4
3806	70	4
3807	130	4
3808	80	4
3809	100	5

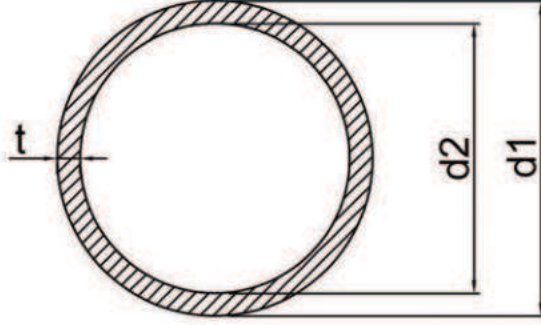

PROFİL NO	d1	d2	t
2800	19	17,1	0,95
2801	22	20,1	0,95
2802	25	23,1	0,95
2803	30	26,0	2,0
2804	40	36,0	2,0
2805	30	27,6	1,2
4001	50	46	2
4002	16	12	2
4005	40	37,4	1,3
4006	16	13,4	1,3
4007	19	16,4	1,3
4008	50	47,4	1,3
4011	50	47	1,5
4009	35	32,2	1,4

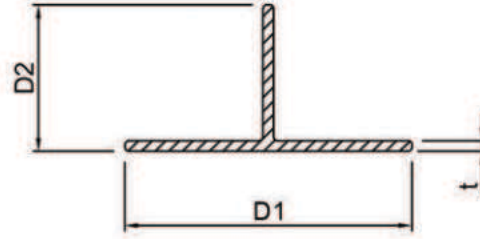

PROFİL NO	d1	d2	t
3201	38	19,4	1,4
1605*	69,5	50	1,7
1621*	50	50	1,7
1622*	50	50	2,0
1626*	50,2	69,5	2,0
1627*	110	45	2,0

*profile with serrated surface

*tırıklı profil yüzeyi

www.regrup.net



SERAMİK CEPHE PROFİLLERİ

CERAMIC FACEDE PROFILES

www.regrup.net

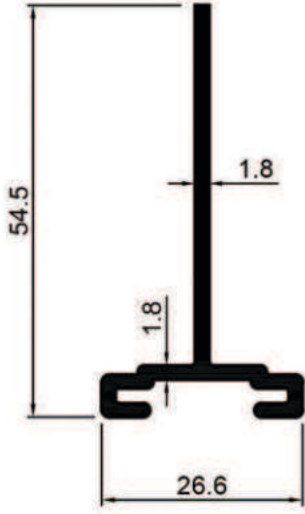

1603

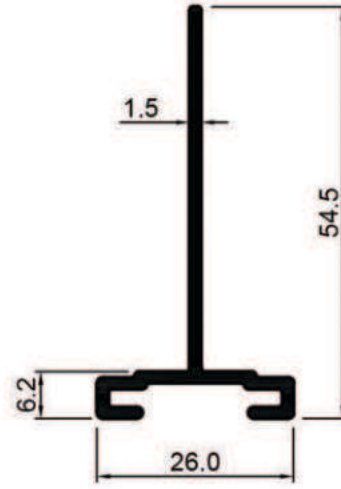

1618

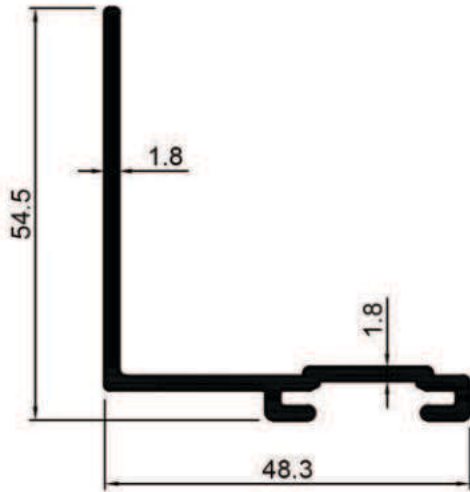

1604



1639

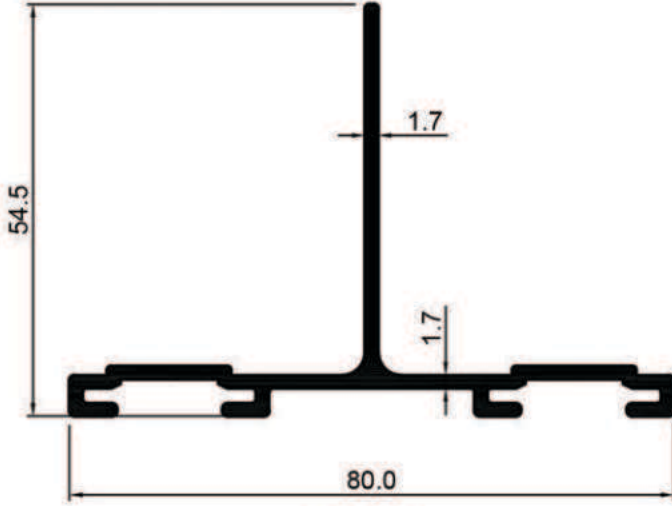

1616

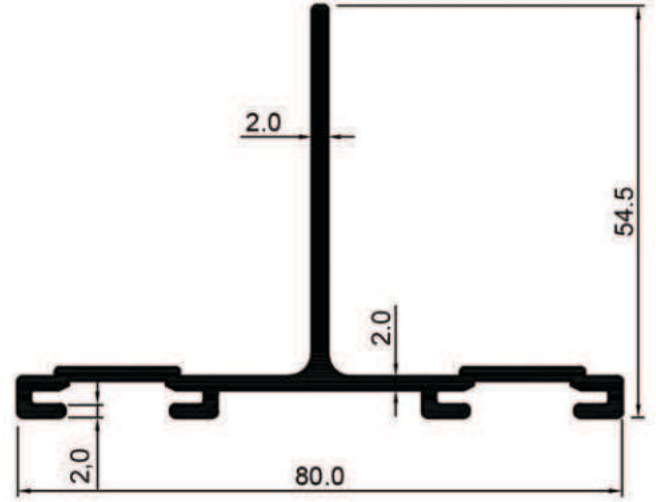

1601

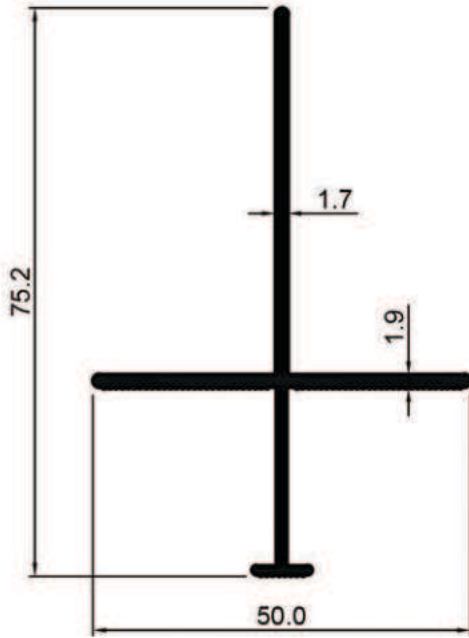

4357

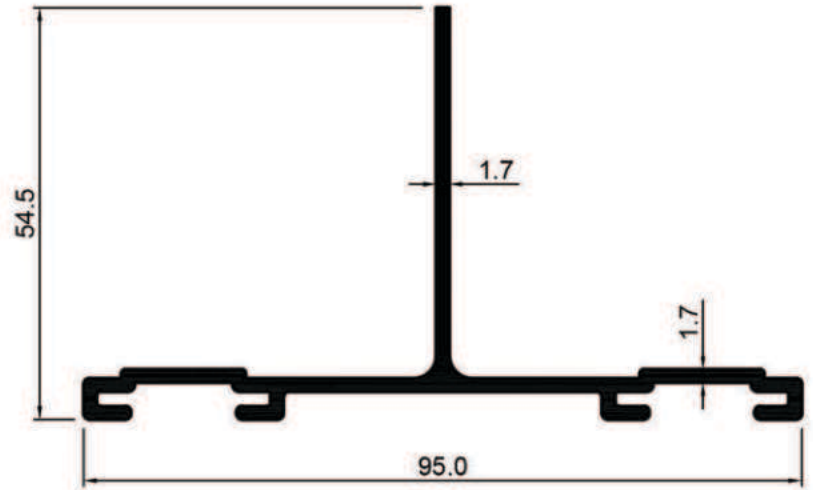

1617

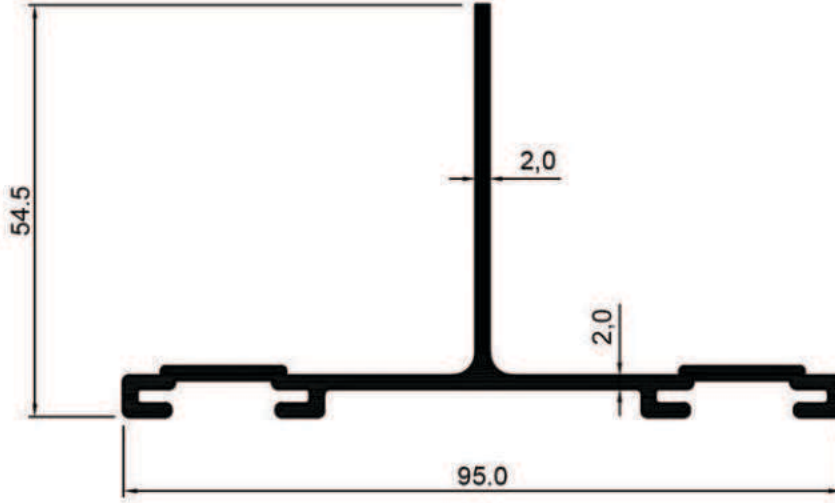

1602

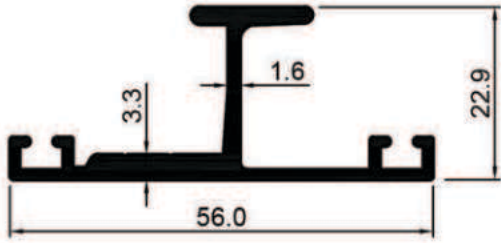

1632

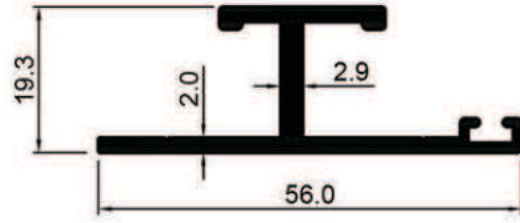

1654

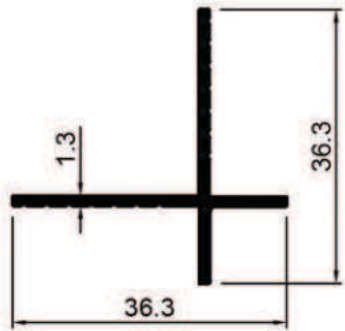

1643

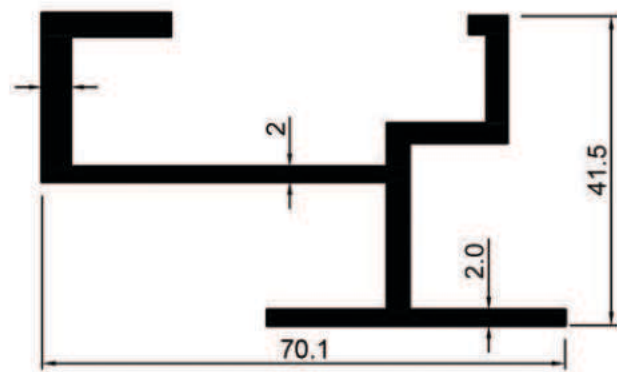

1671

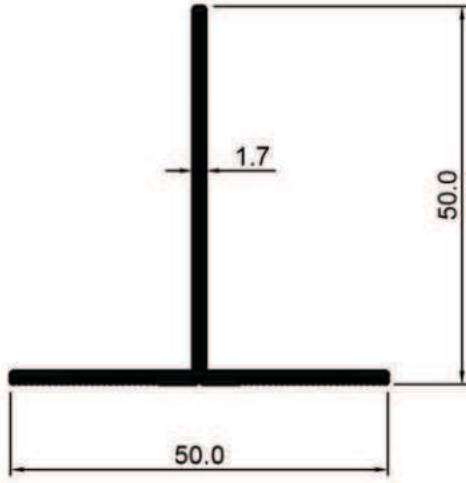

1621

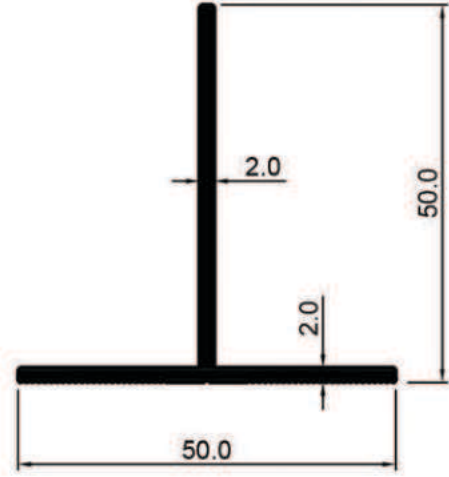

1622

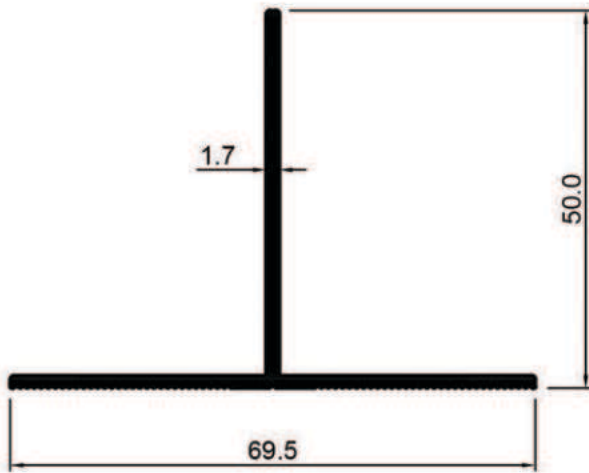

1605

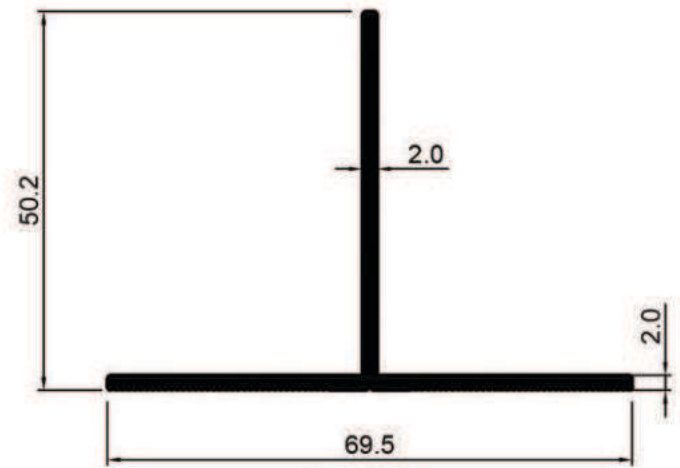

1626

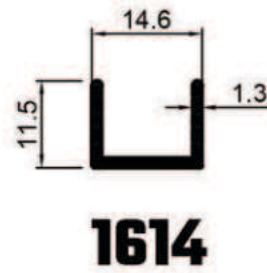
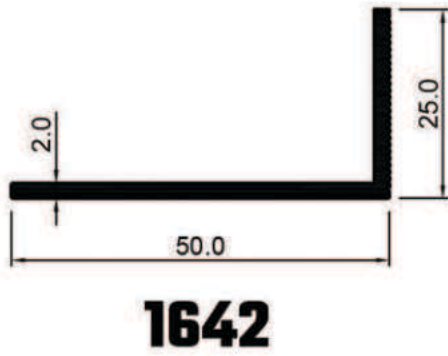
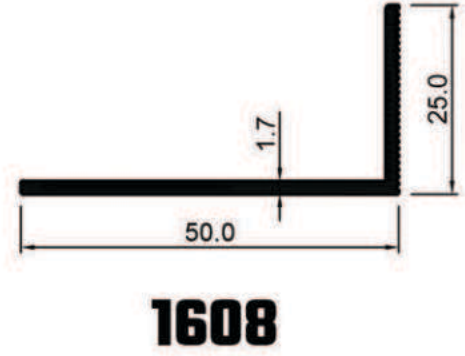
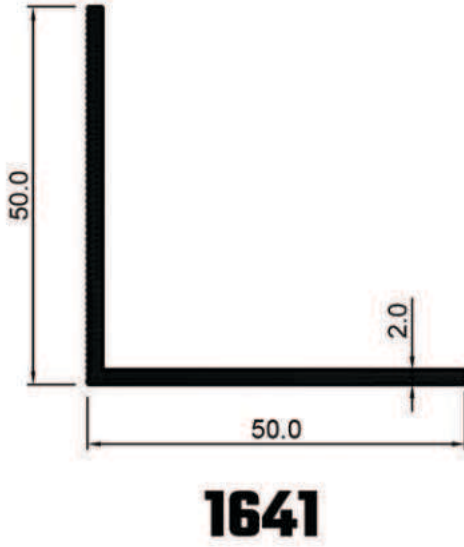
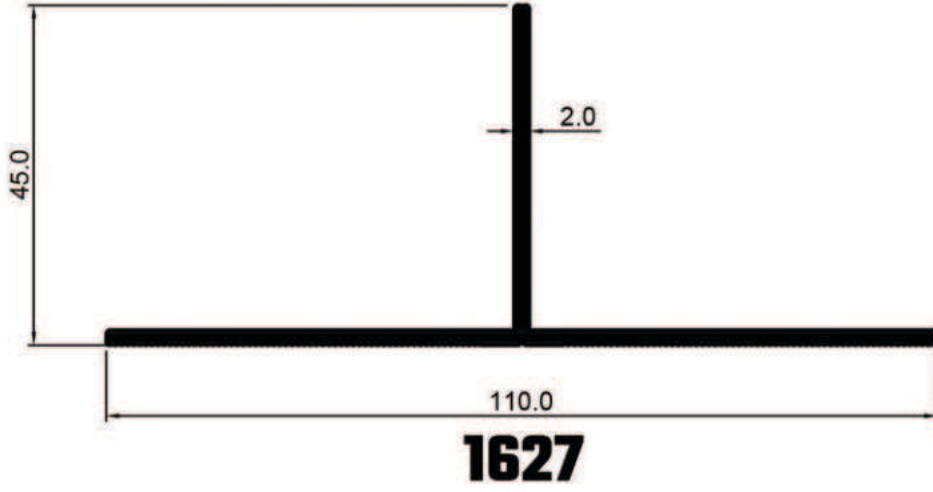

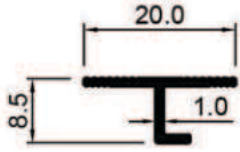

1606

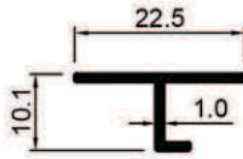

1607

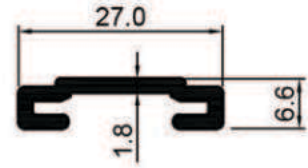

1640

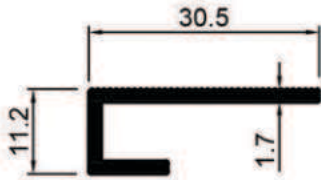

1655

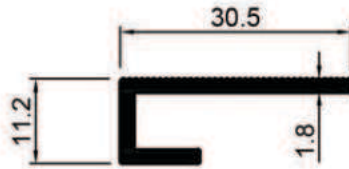

1652

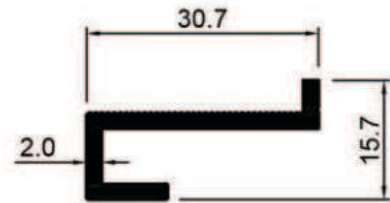

1651

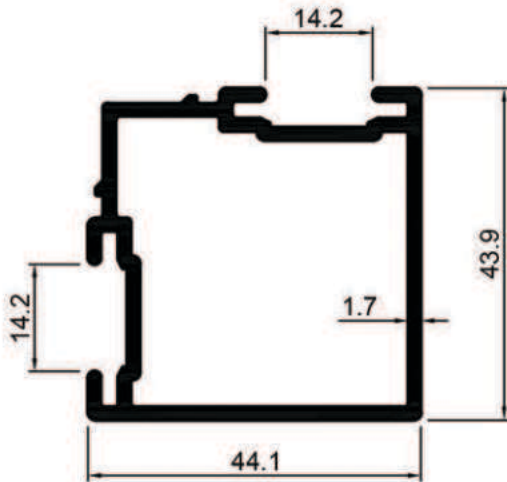

1609

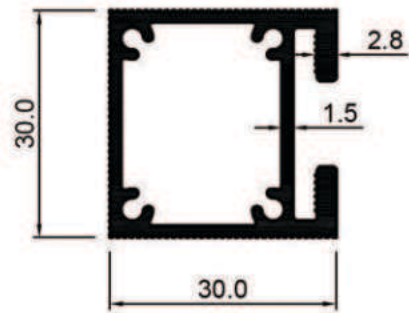

1628

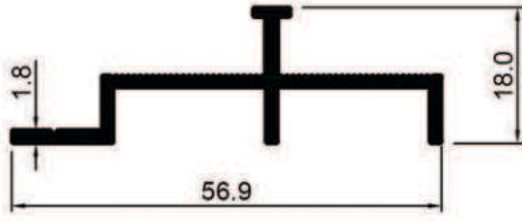

1645

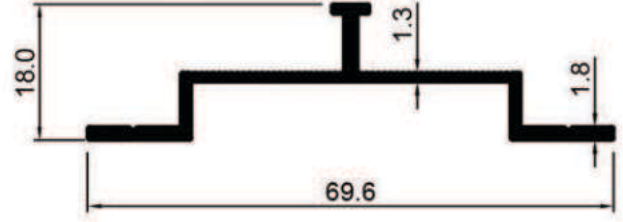

1620

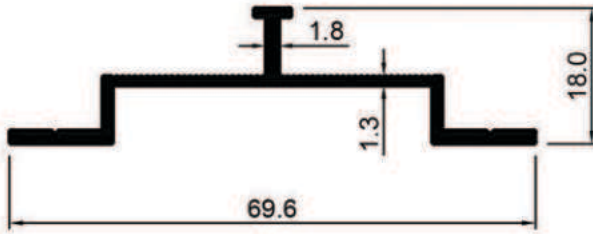

1625

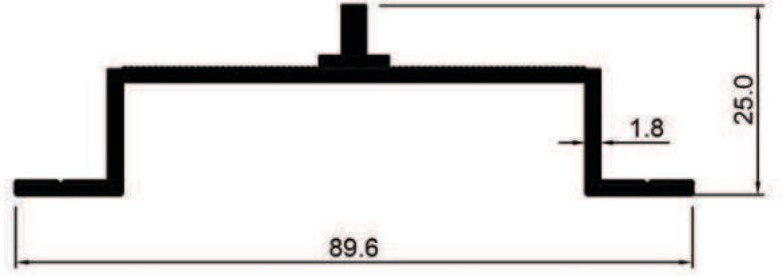

1638

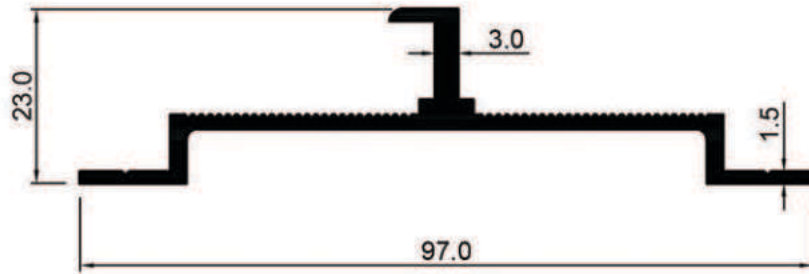

1629

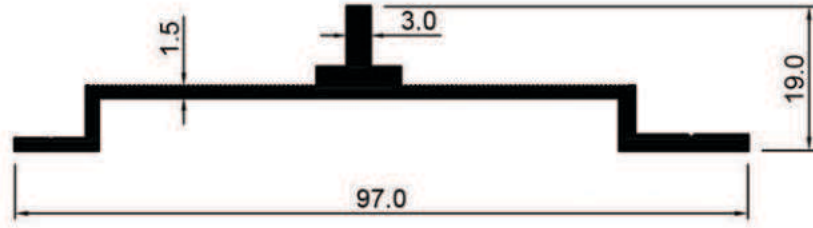

1624

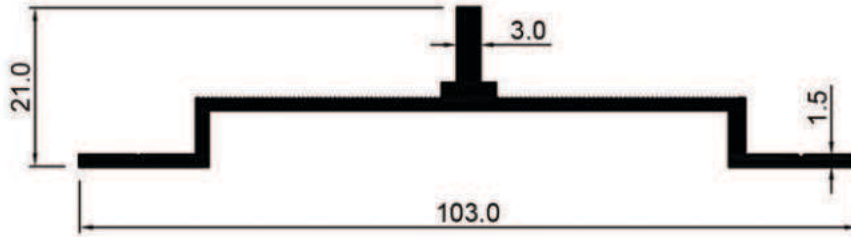

1630

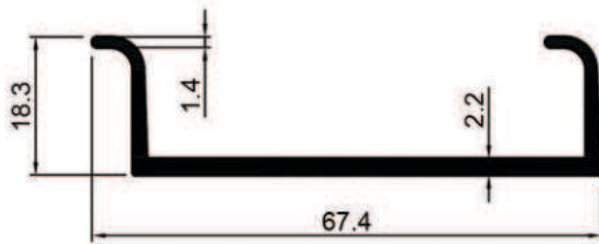

4356

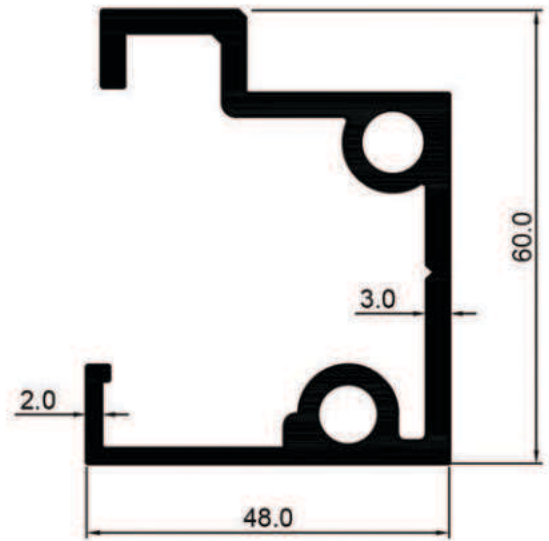

1633

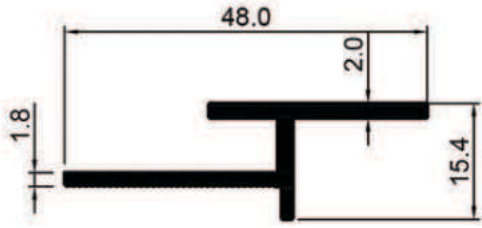

1653

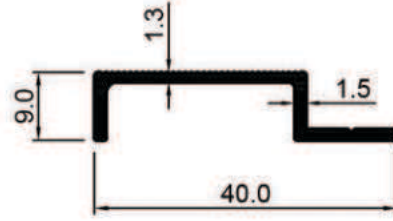

1619

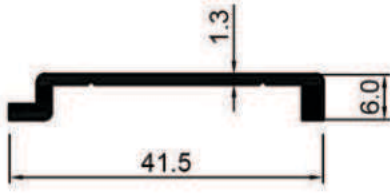

1615

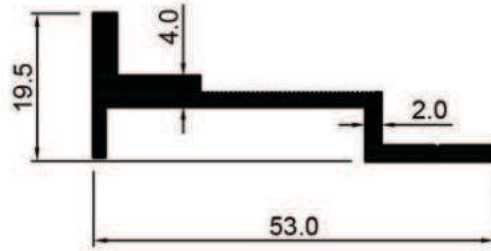

1623

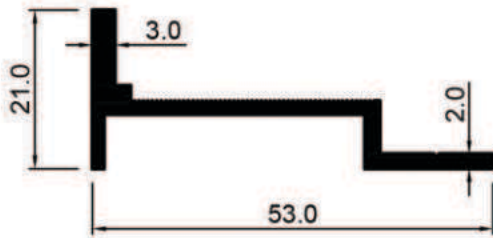

1631

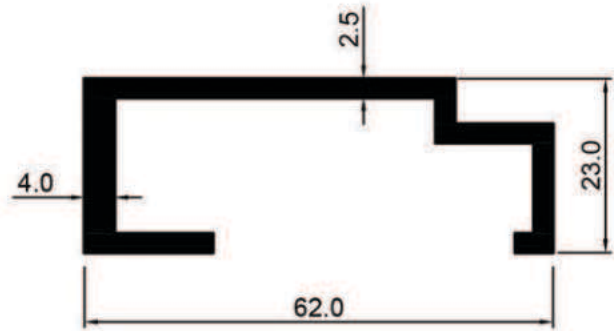

1670

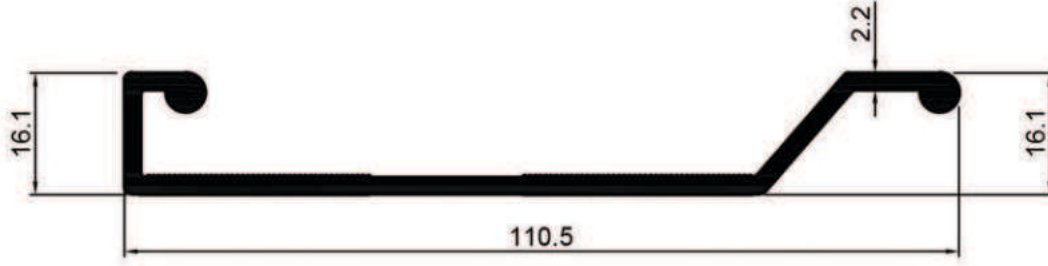

1611

1612

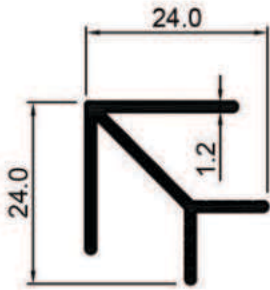
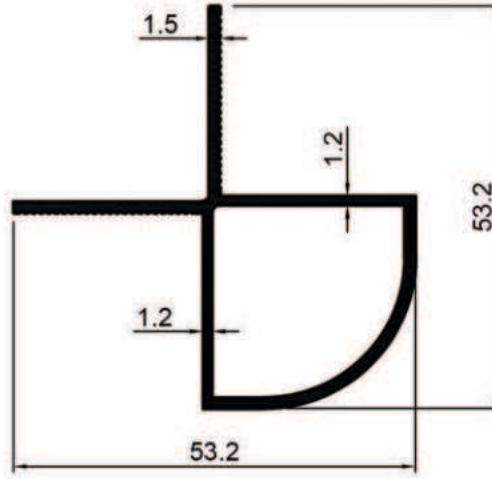

1613

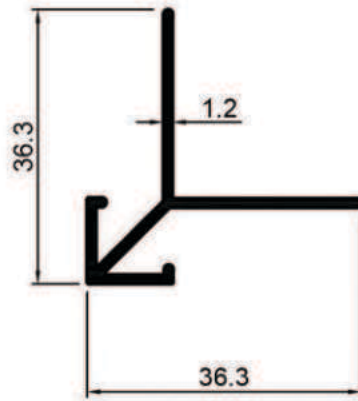

1610

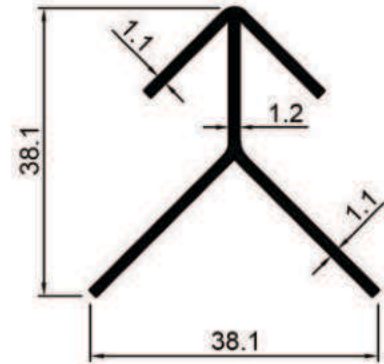

1644

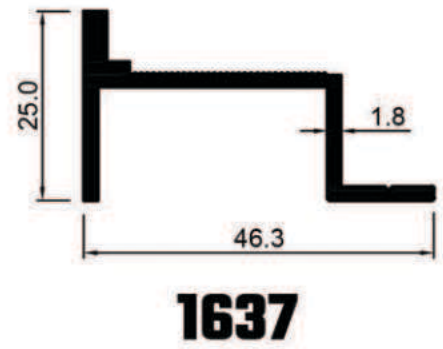
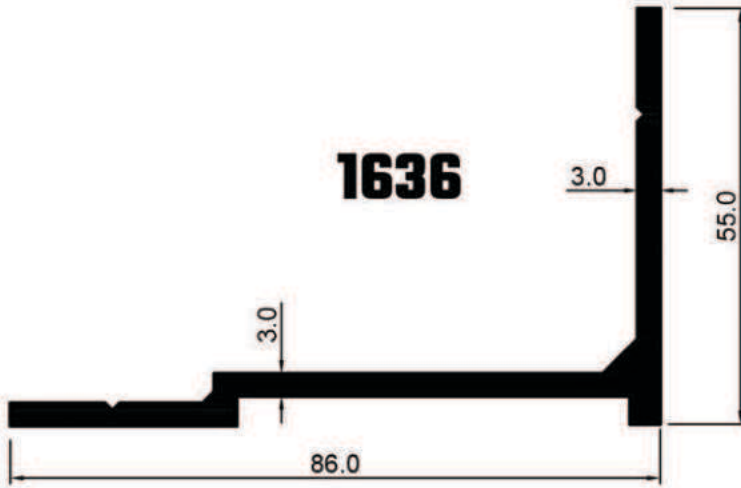
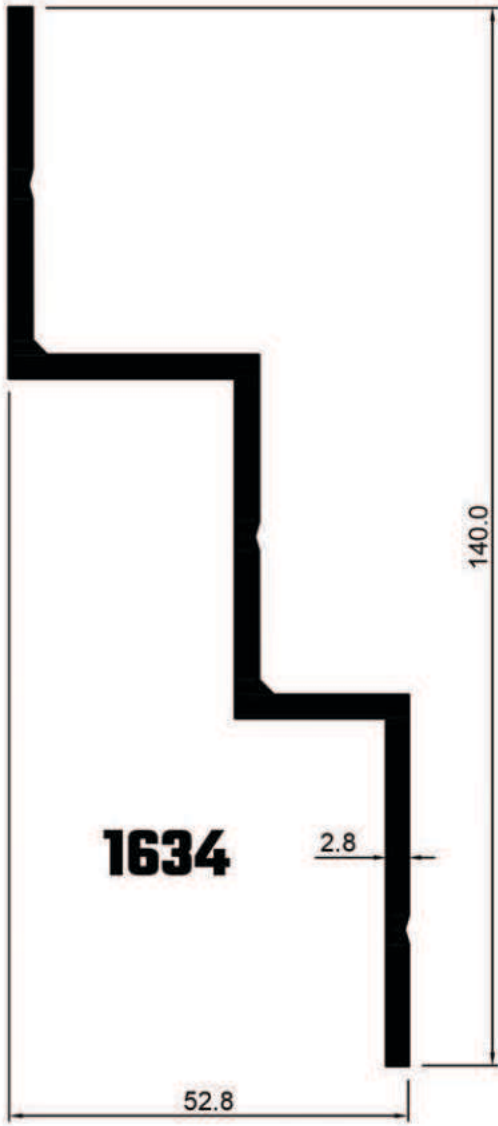

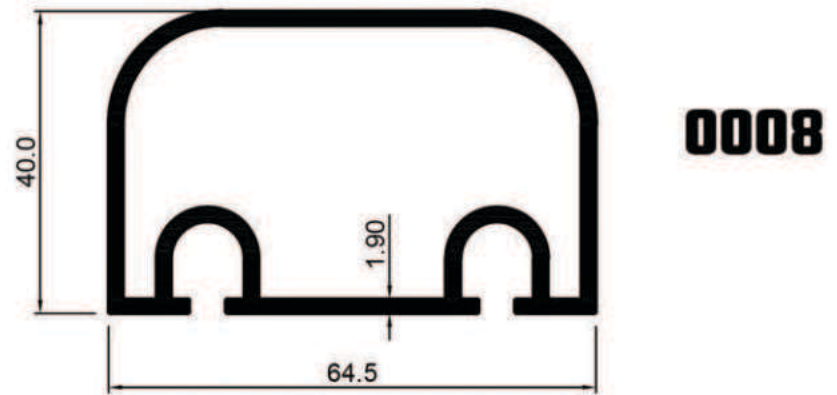
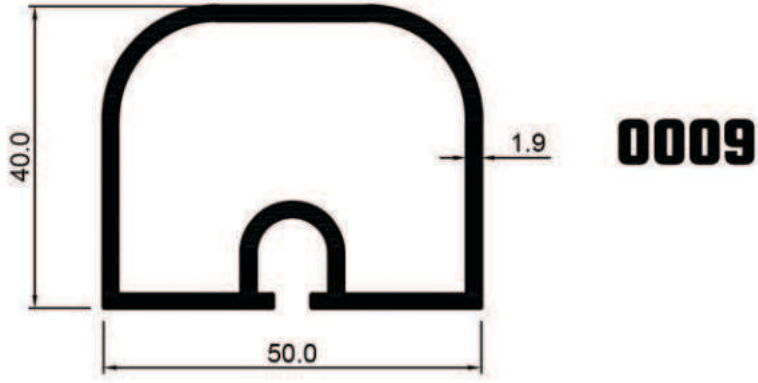



GİYDİRME CEPHE PROFİLLERİ

CURTAIN WALL PROFILES

www.regrup.net

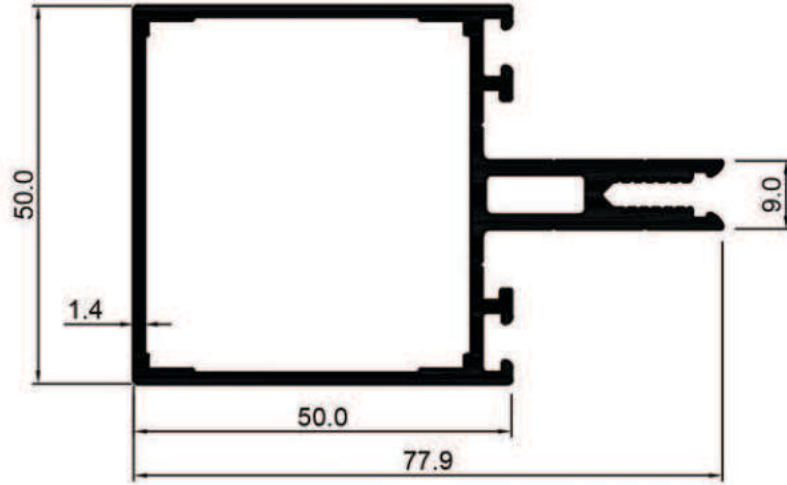

1701

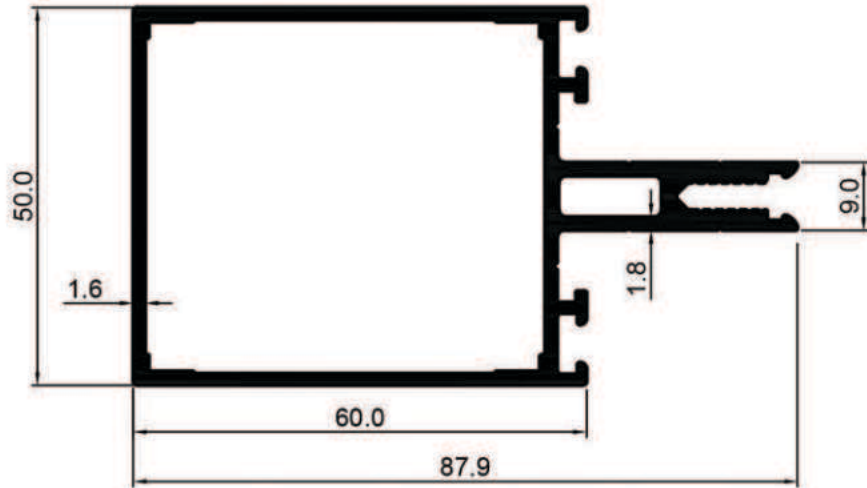

1702

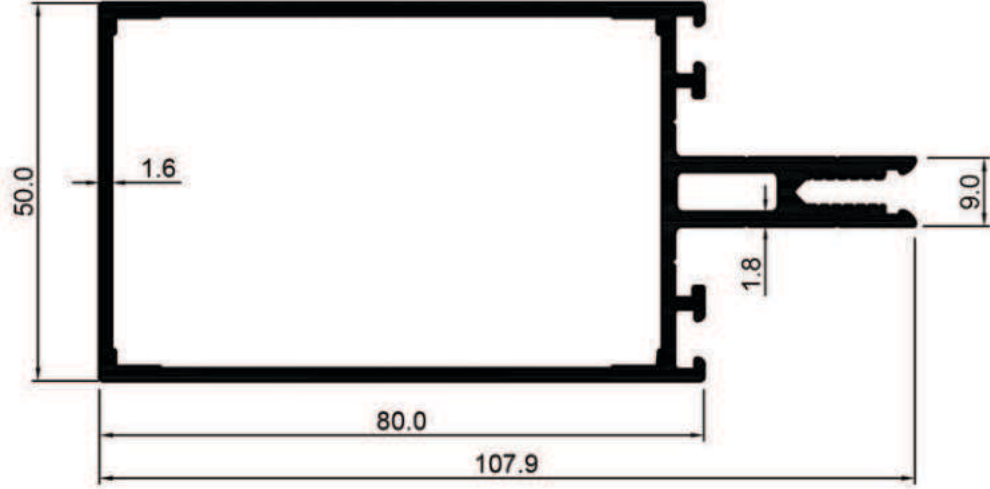

1703

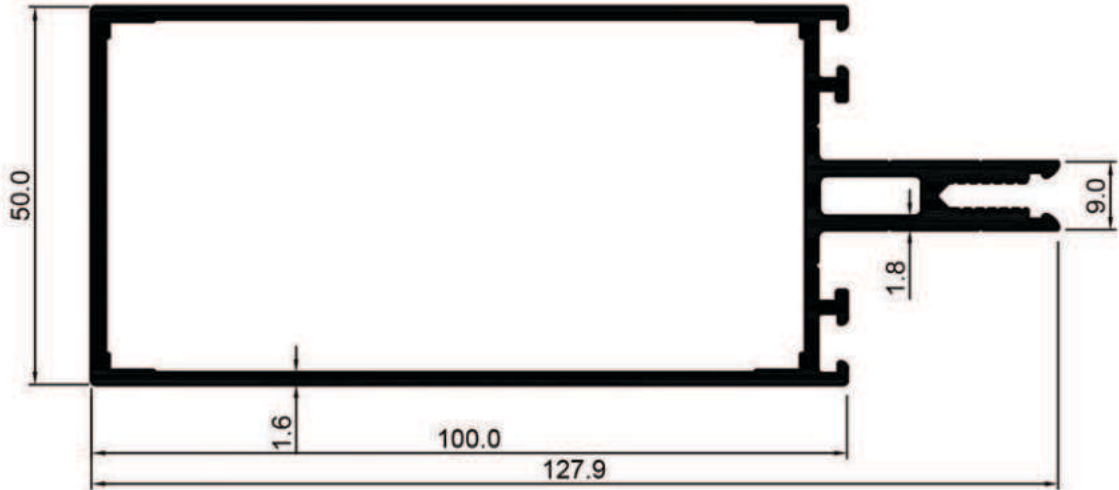

1704

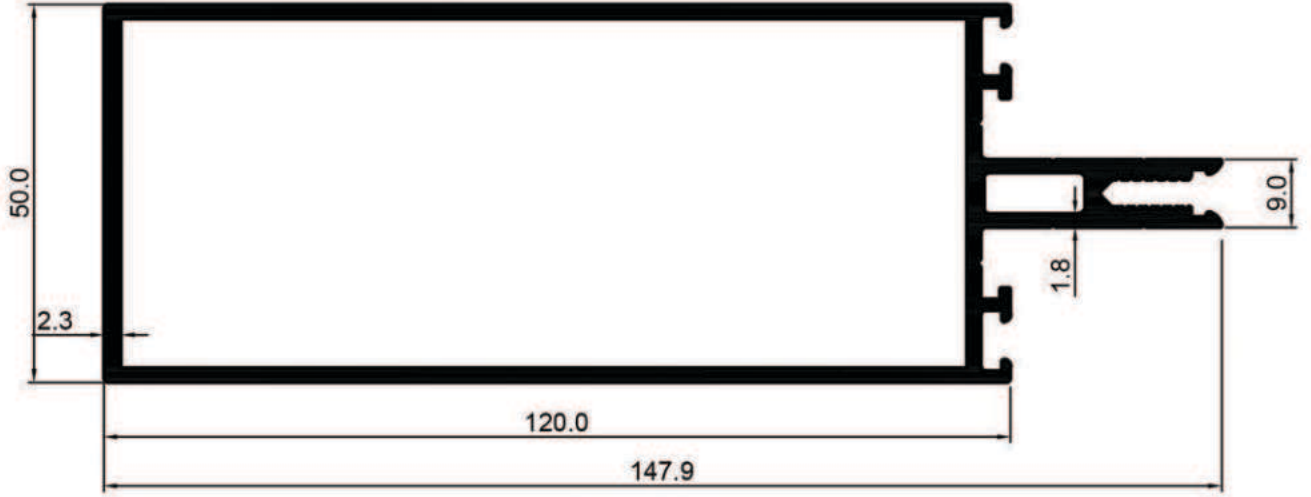

1705

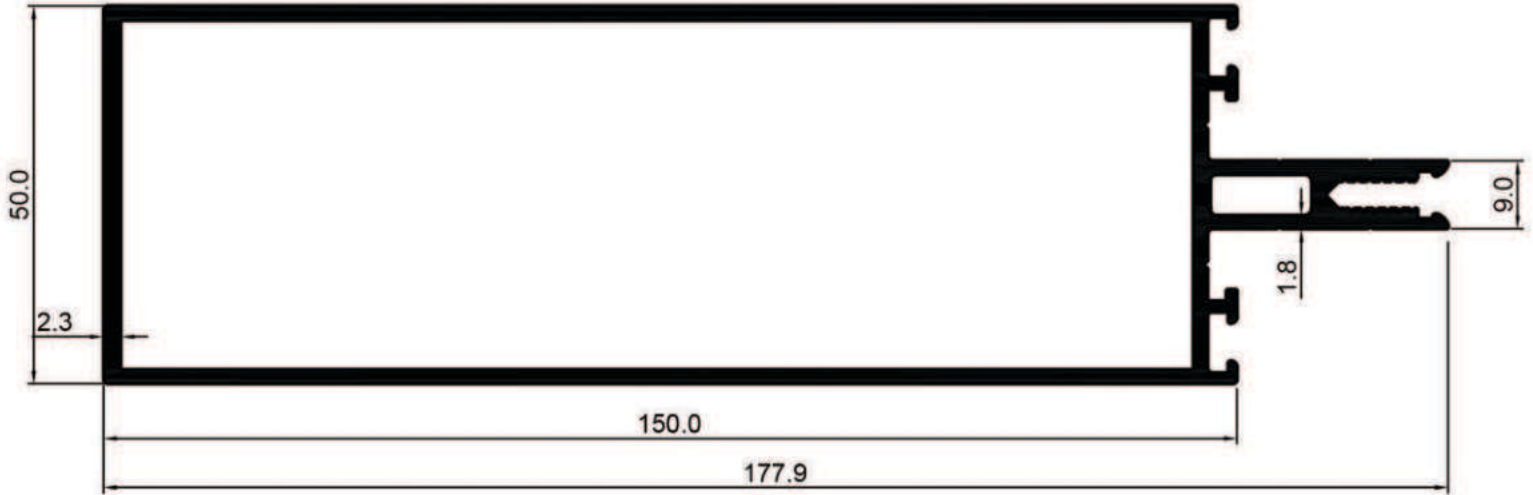

1706

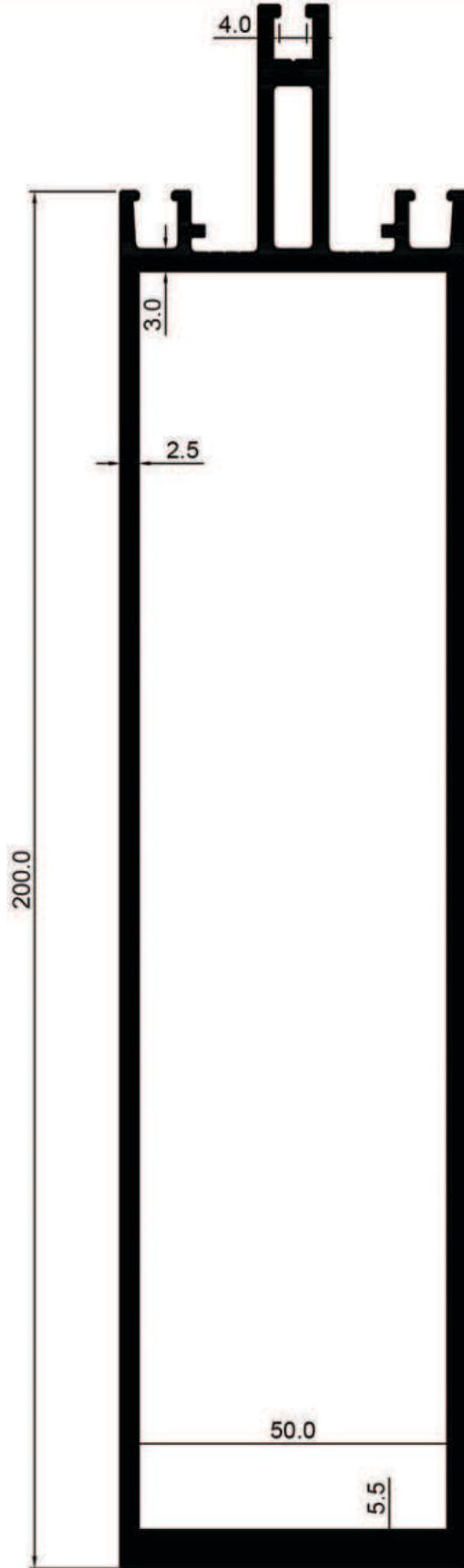

1708

www.regrup.net

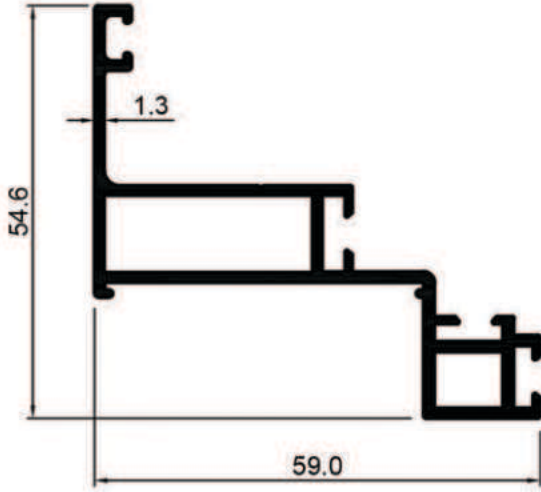

1713

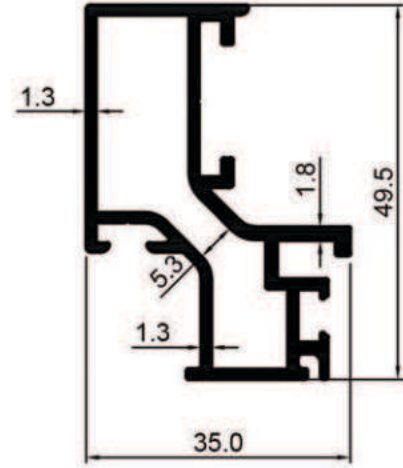

1714

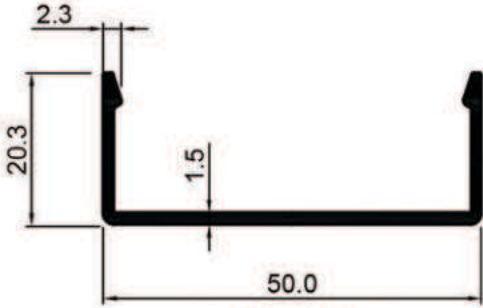

1711



1712

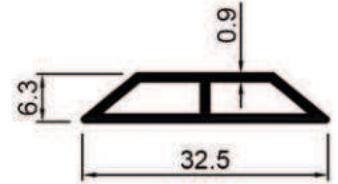

0855

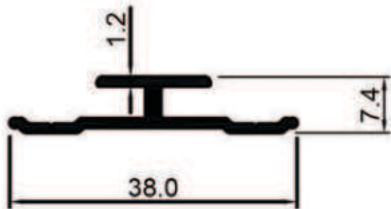

4459

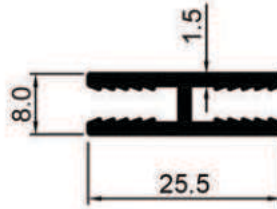

1715

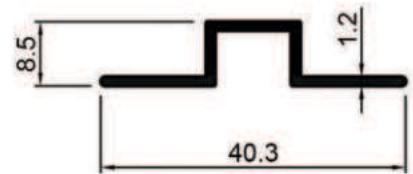

0853



C-60 PROFİLLERİ

C-60 PROFILES

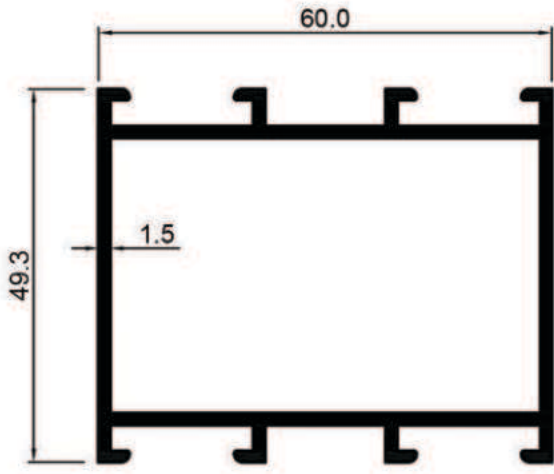

1503

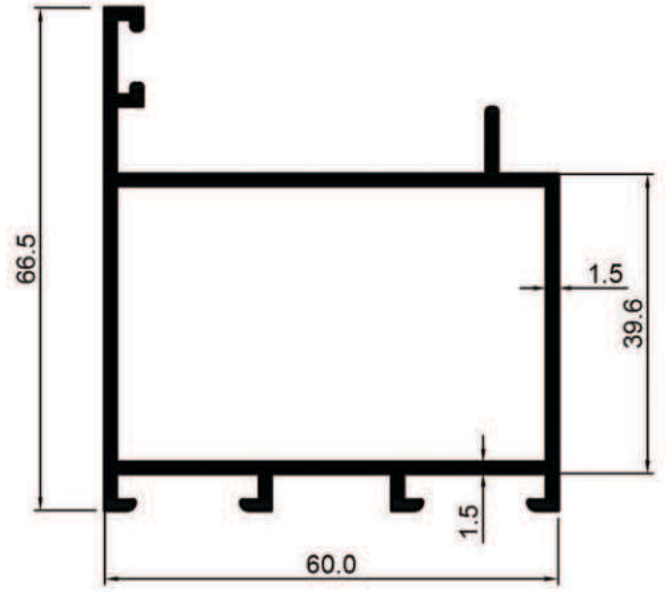

1504

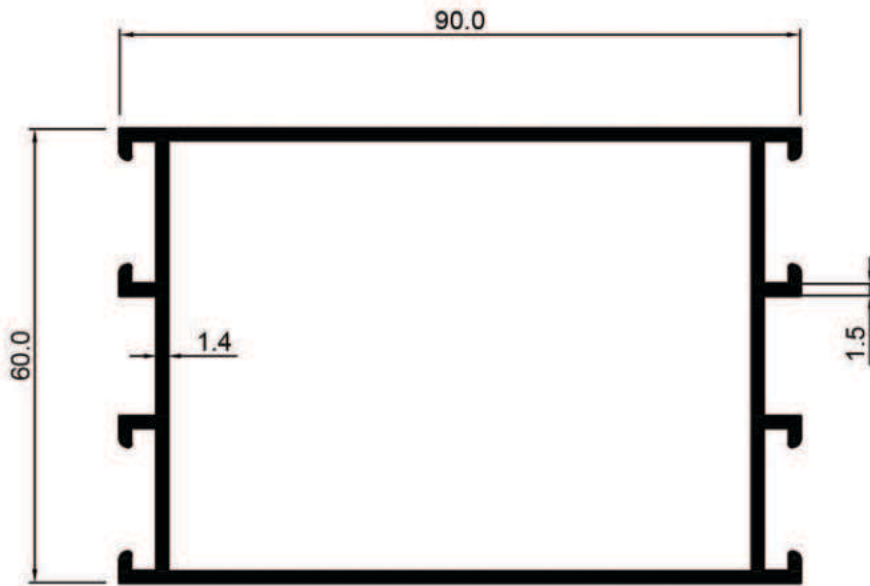

1511

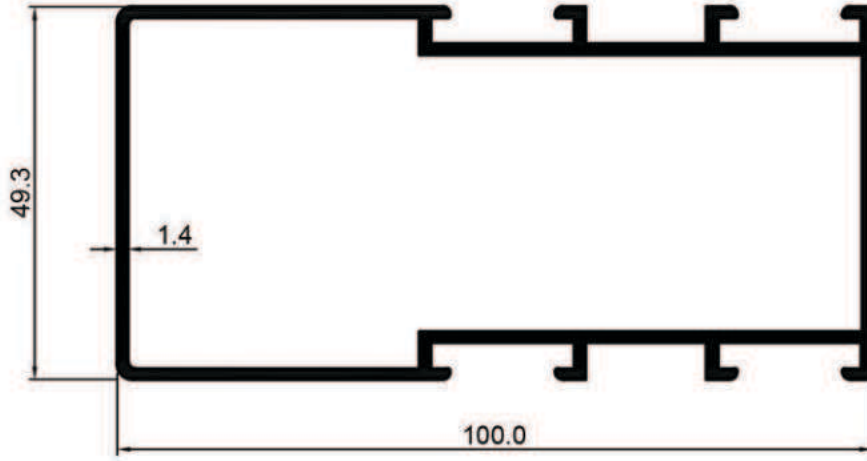

1509

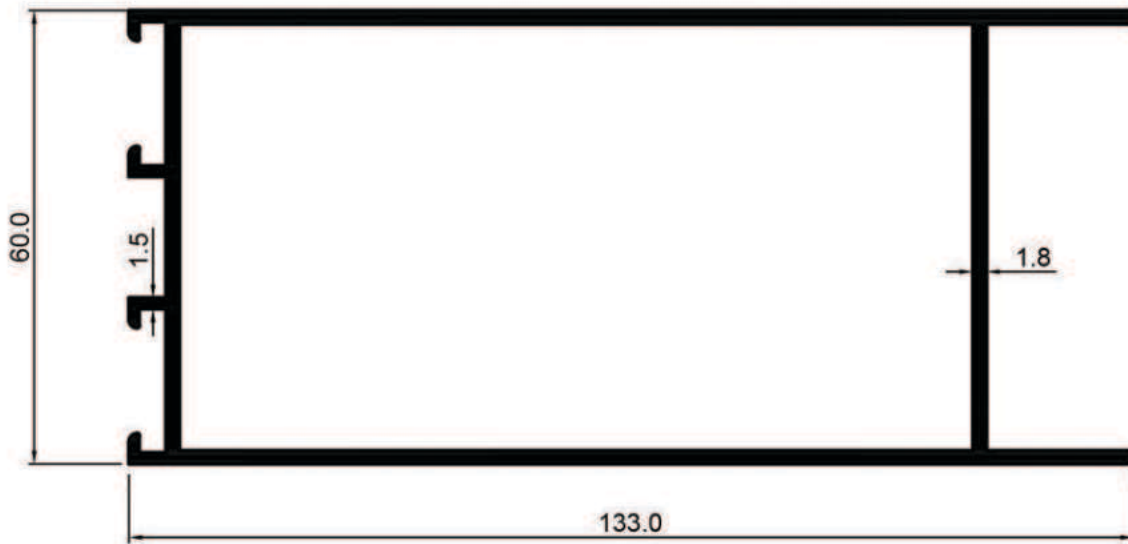

1502

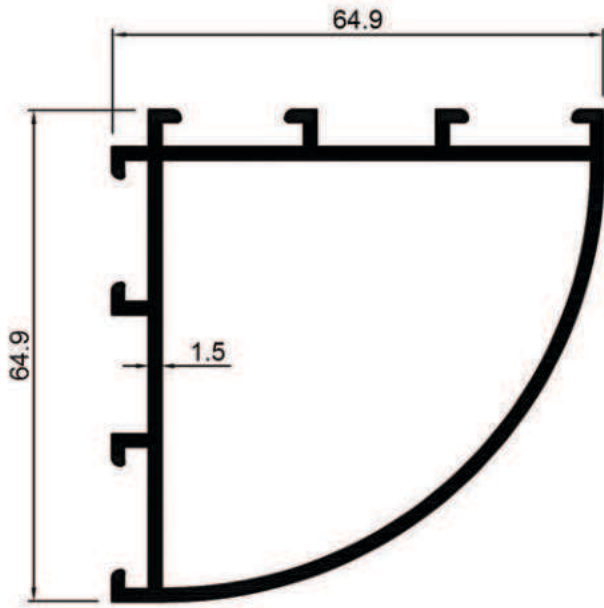

1510

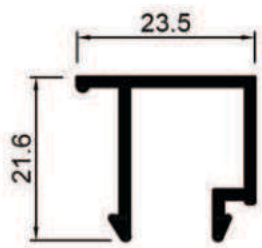

1506

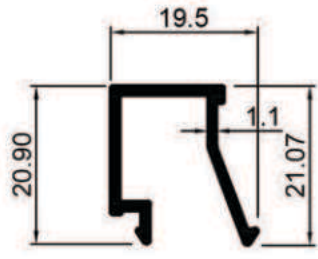

1514

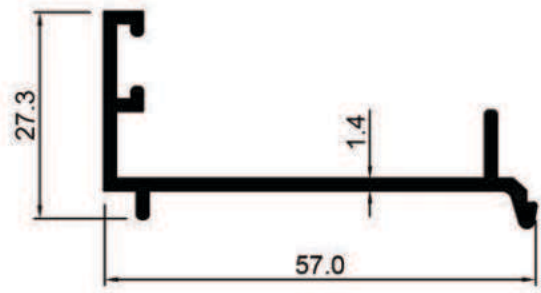
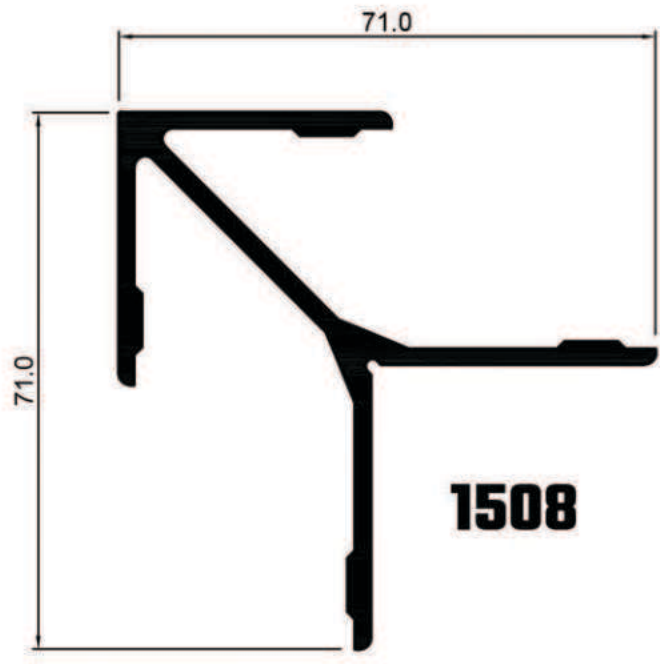

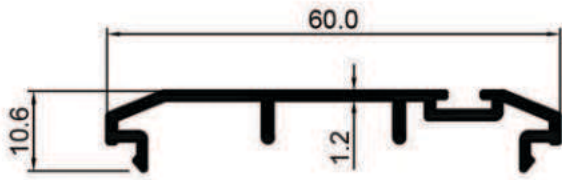

1512

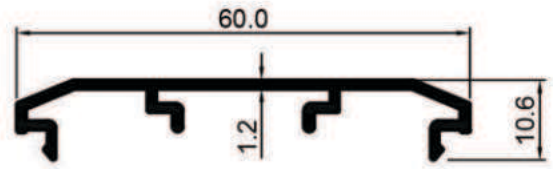

1513

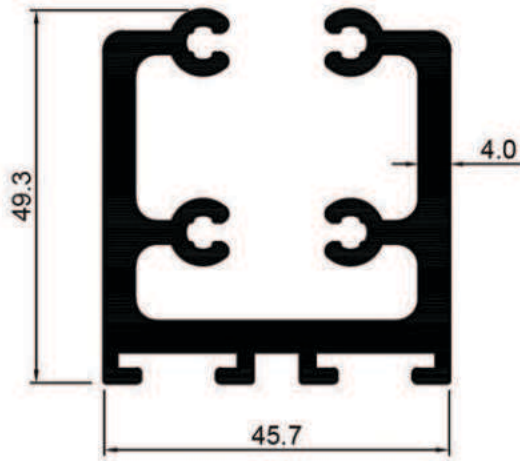

1501

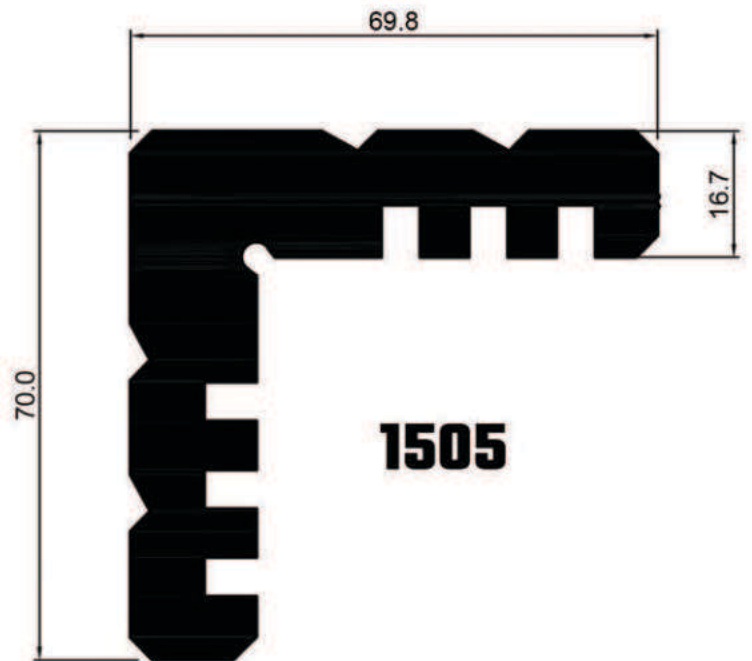

1505



ALDOKS PROFİLLERİ

ALDOKS PROFILES

www.regrup.net

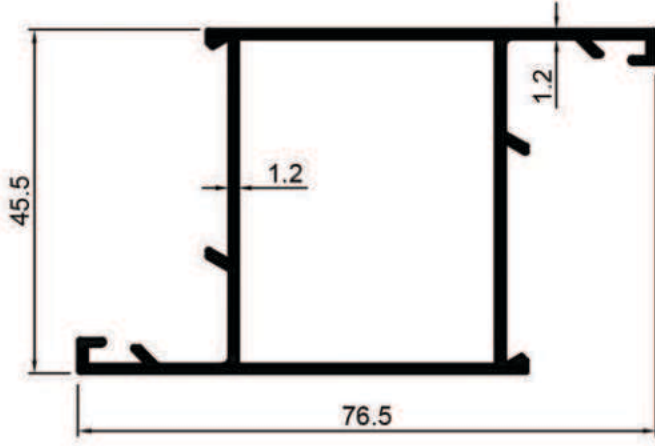

1155

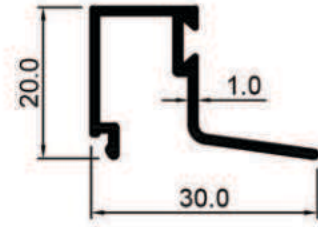

1152

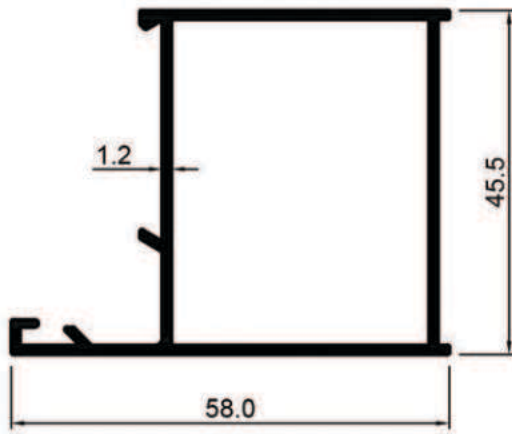

1153

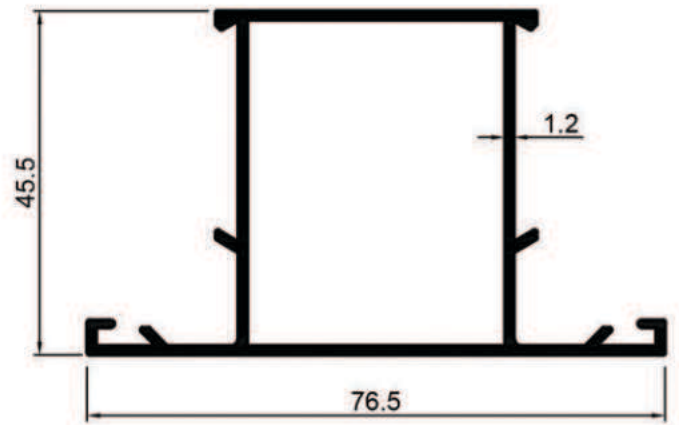

1154

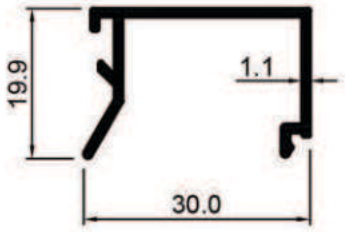

1151

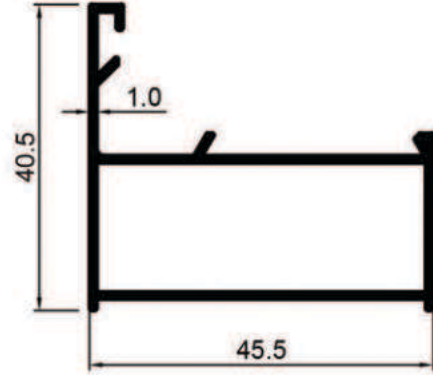

1157

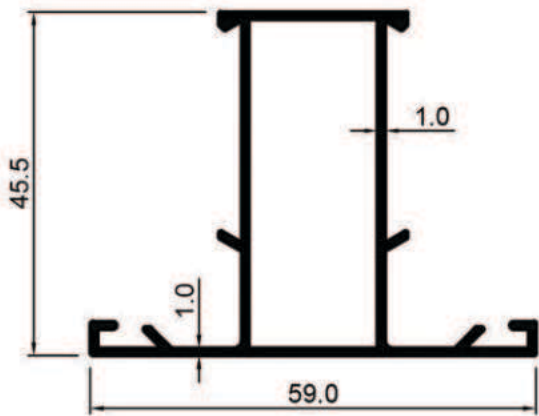

1158

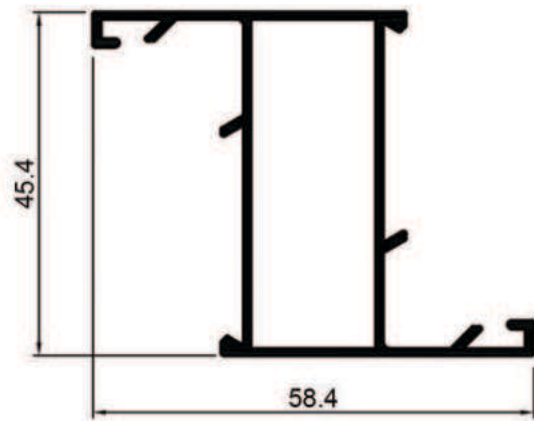

1159

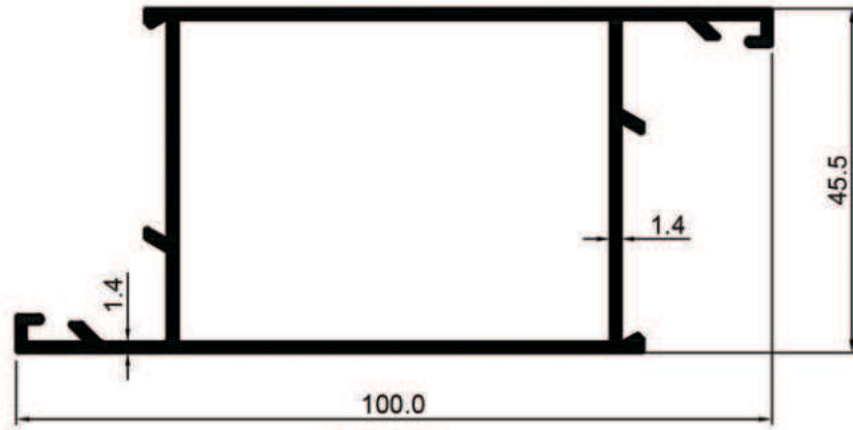

1160

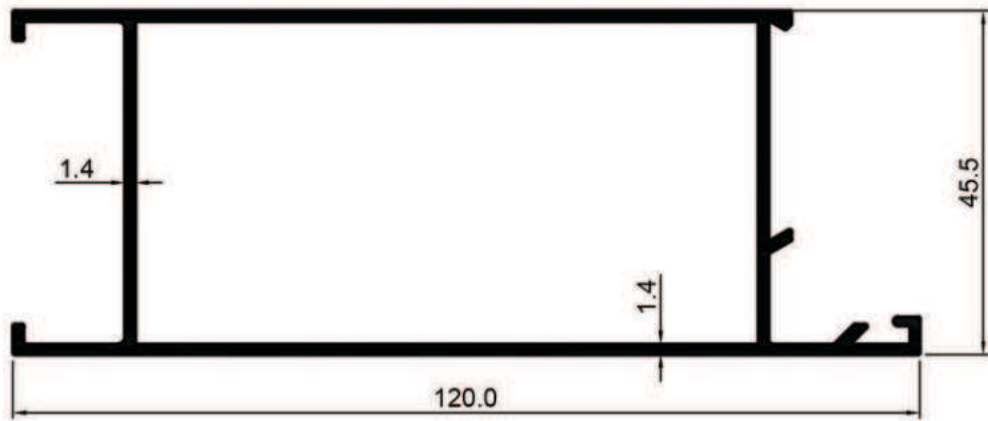

1161

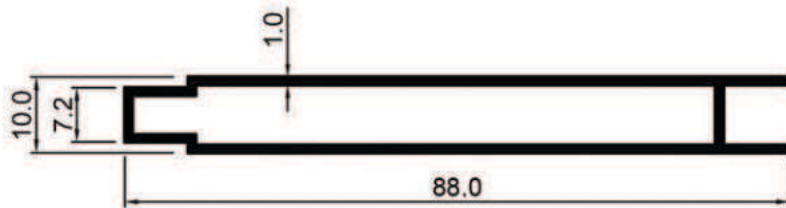

1162



TUBA SERİSİ PROFİLLERİ

TUBA SERIES PROFILES

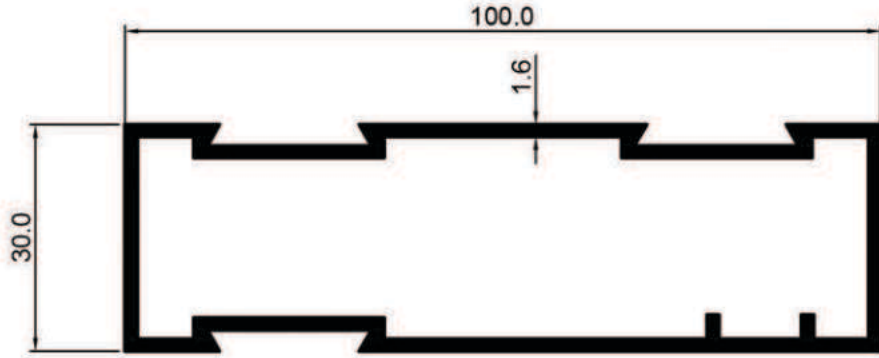

1401

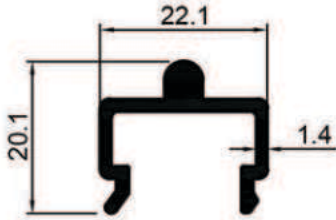

1402

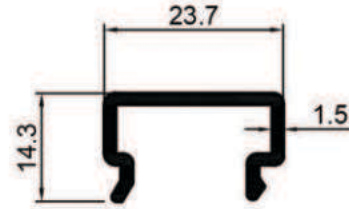

1403

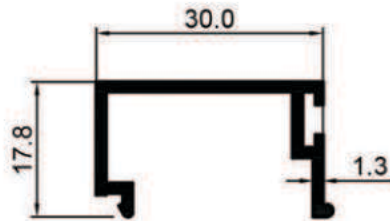

1406

1404

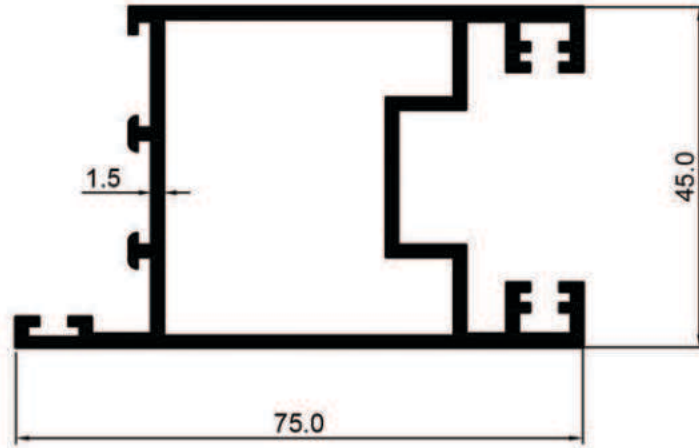

1405

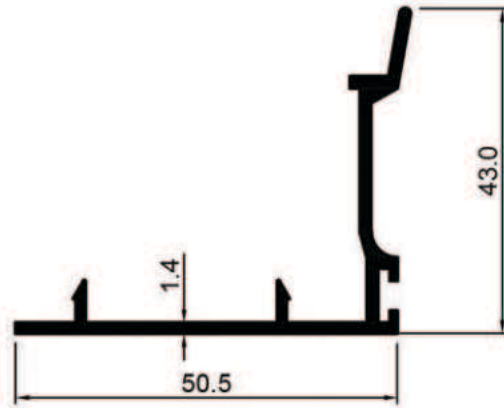

1407

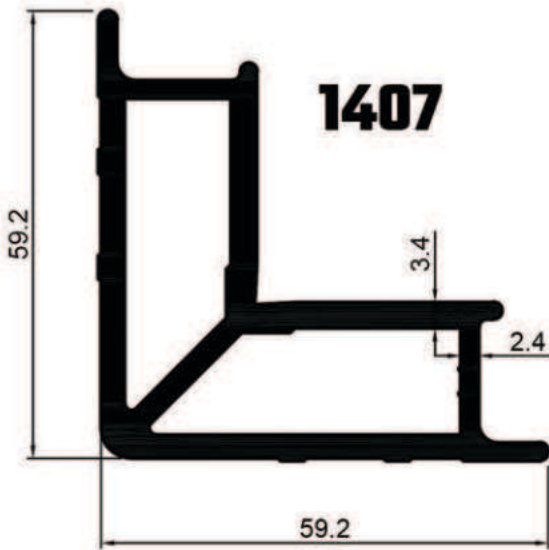

1408

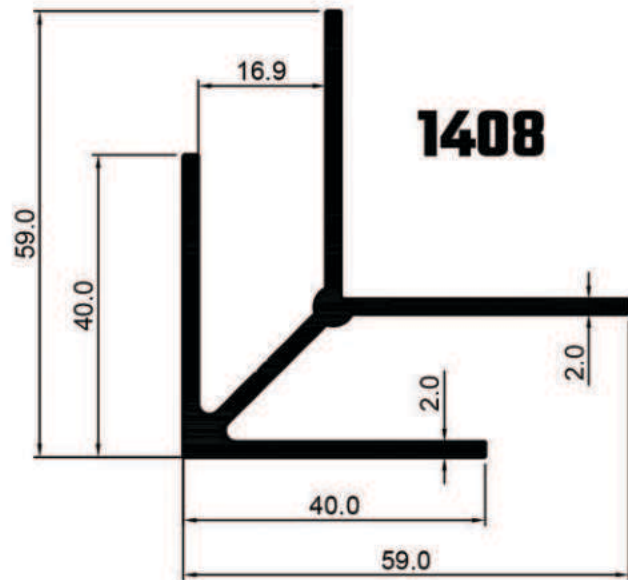



CAM BALKON PROFİLLERİ

GLASS BALCONY PROFILES

www.regrup.net

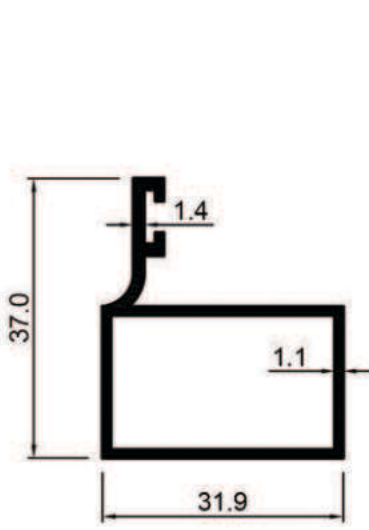

2201

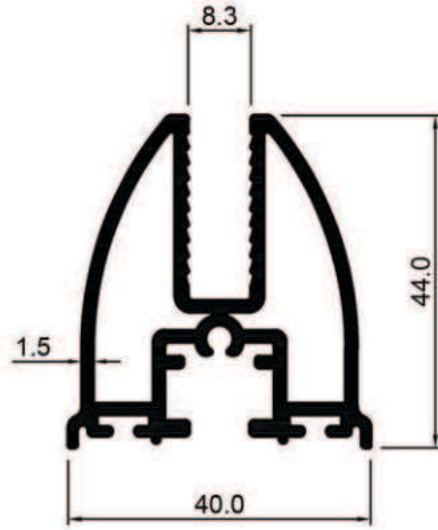

2202

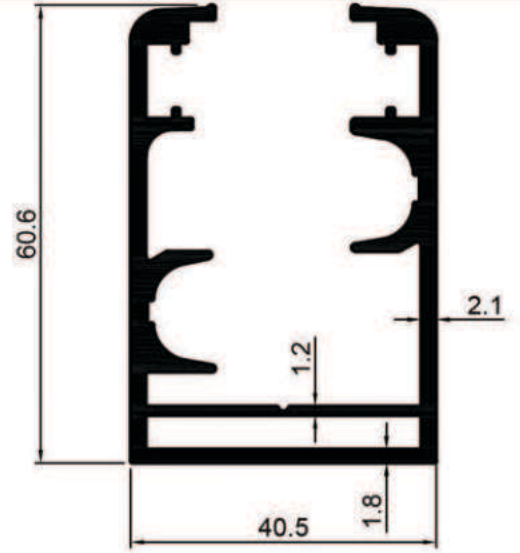

2203

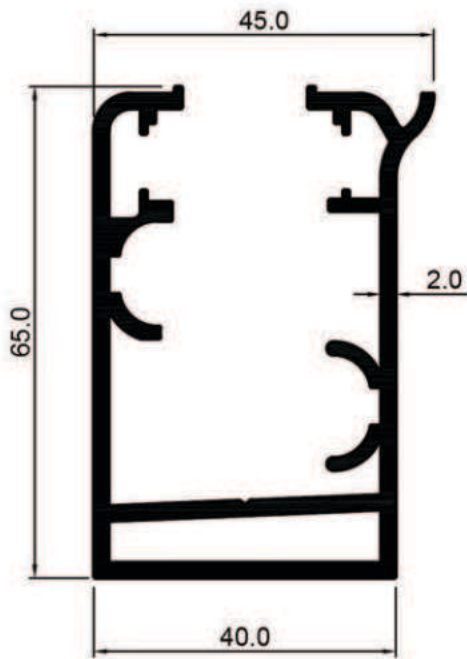

2231

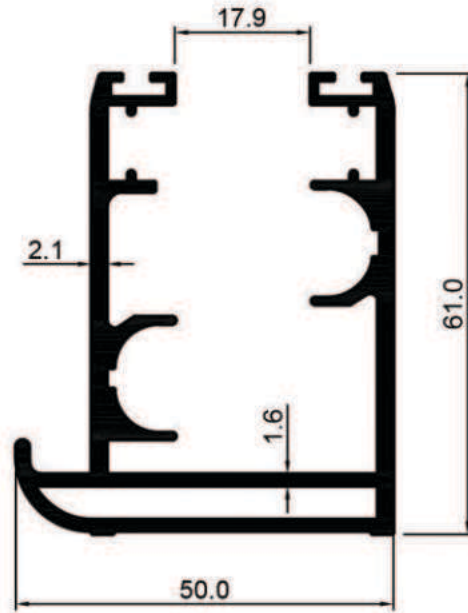

2228

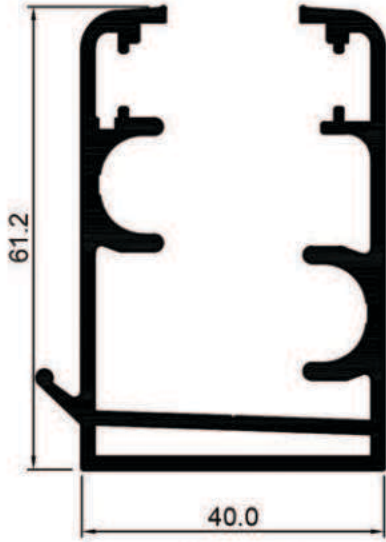

2216
1,324
Kg/m

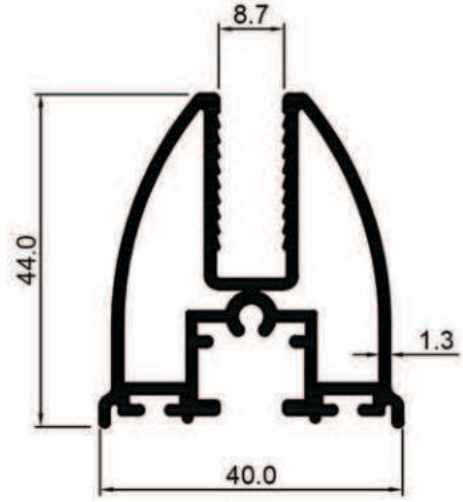

2217
0,887
Kg/m

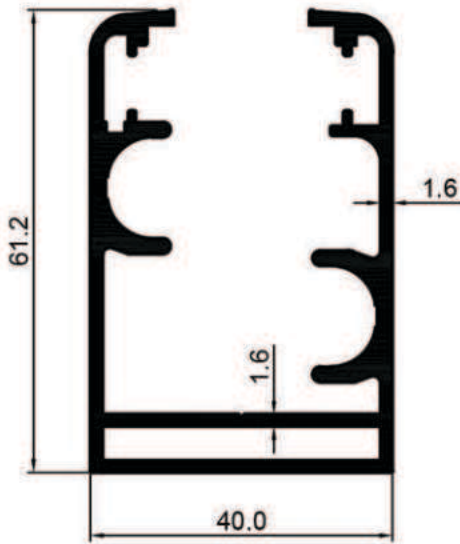

2220
1,289
Kg/m

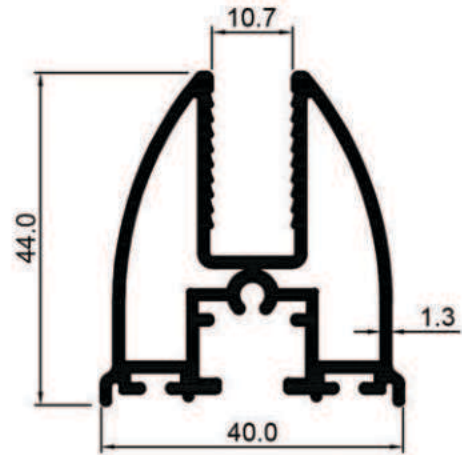

2219
0,887
Kg/m

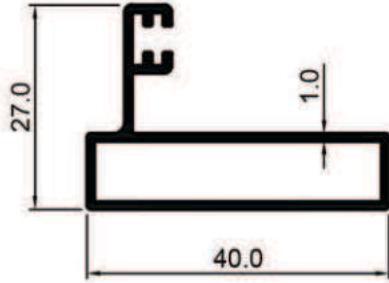

2218

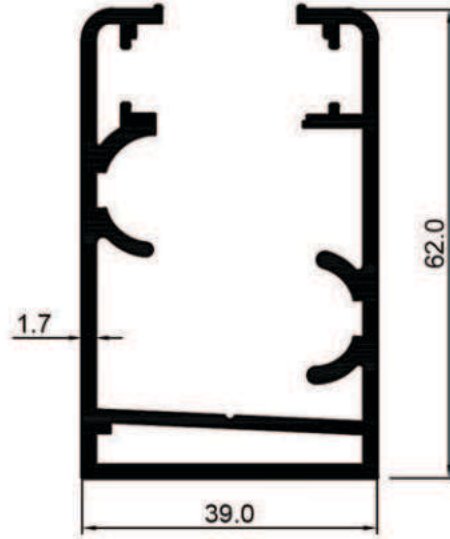

2240

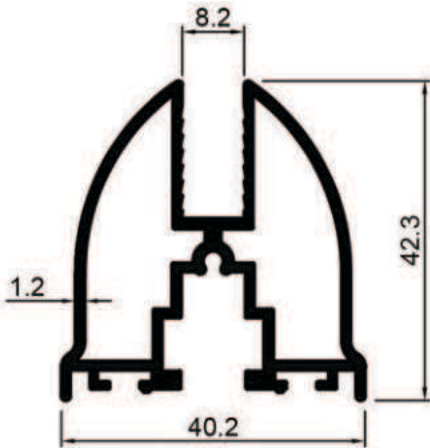

2238

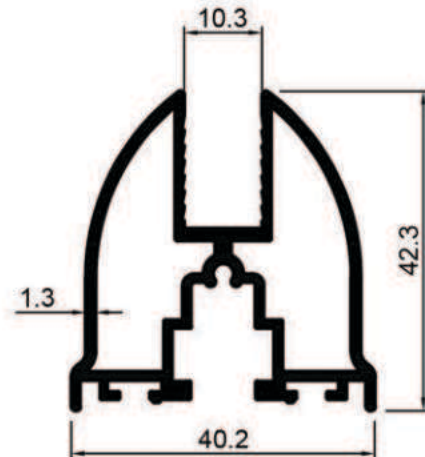

2239

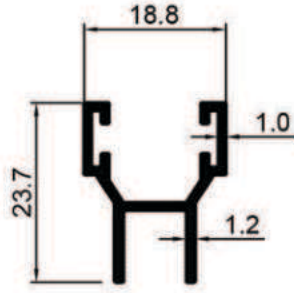

2221

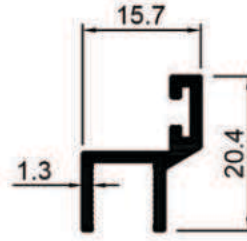

2222

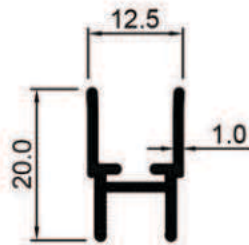

2223

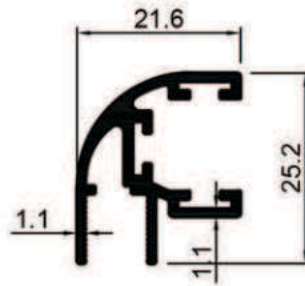

2224



CAM BALKON PROFİLLERİ SÜRME SERİSİ

GLASS BALCONY PROFILES

www.regrup.net

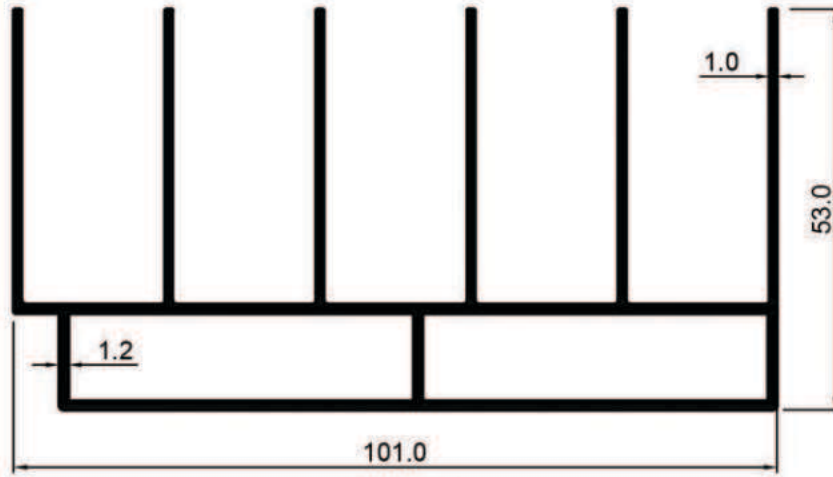

2251

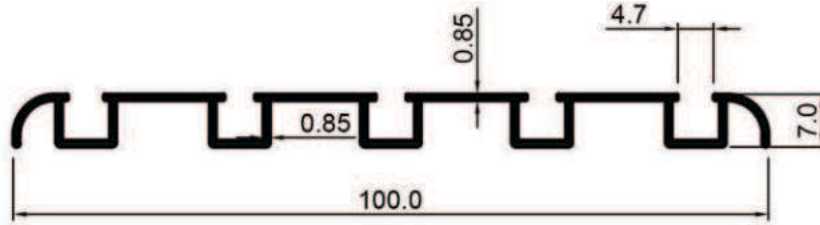

2253

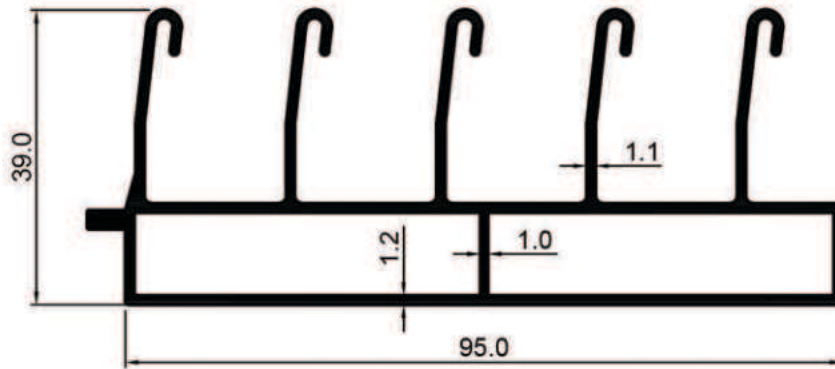

2254

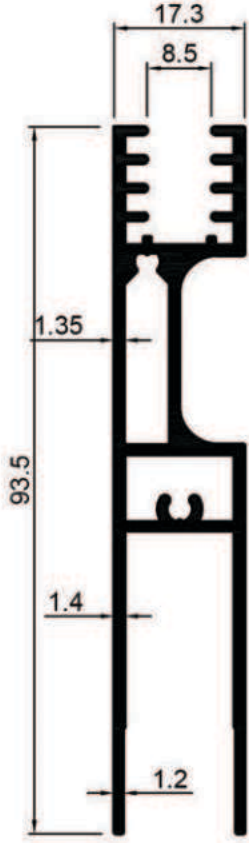

2255

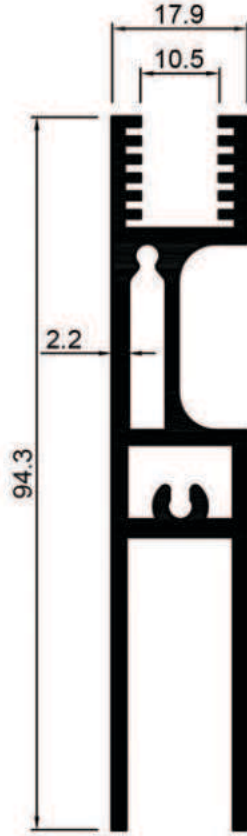

2258

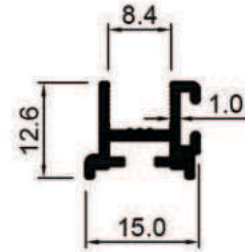

2257



2256

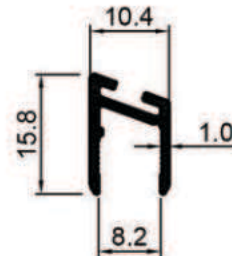

2252

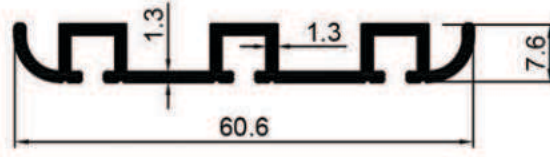

2259

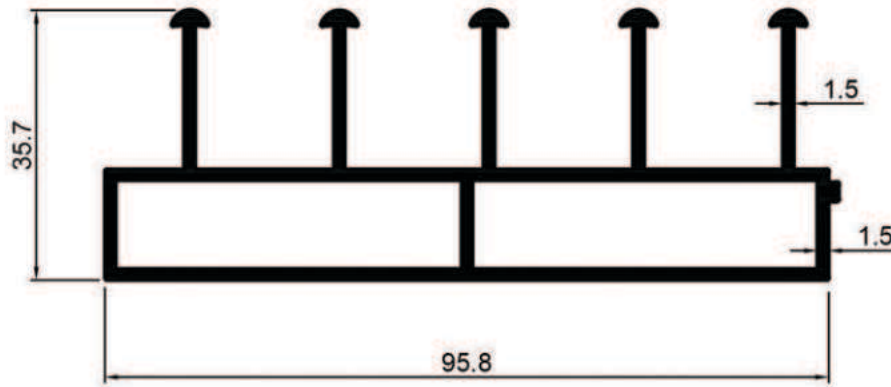

2260

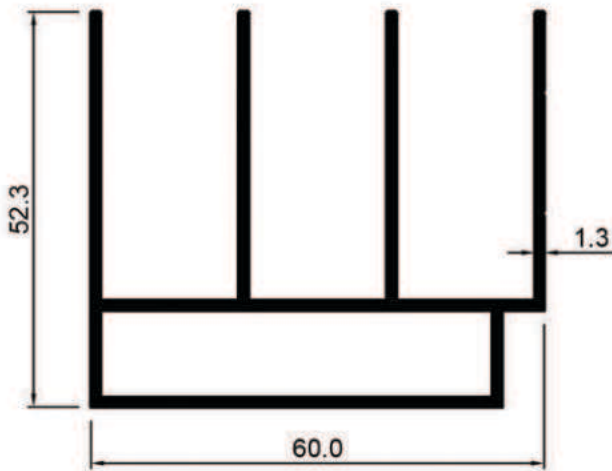

2261

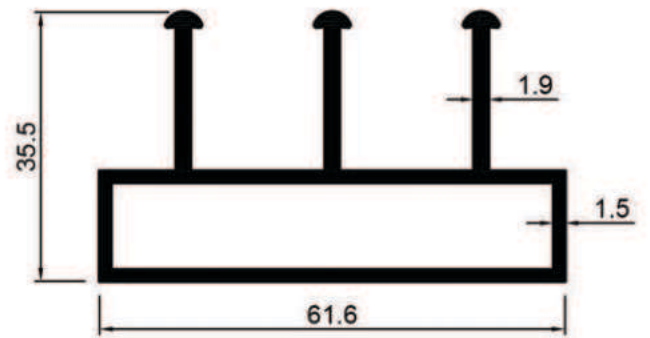

2262



PANJUR ve KEPENK PROFİLLERİ

BLINDS and SHUTTERS PROFILES

www.regrup.net

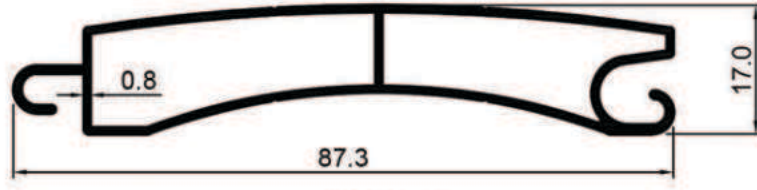

1102

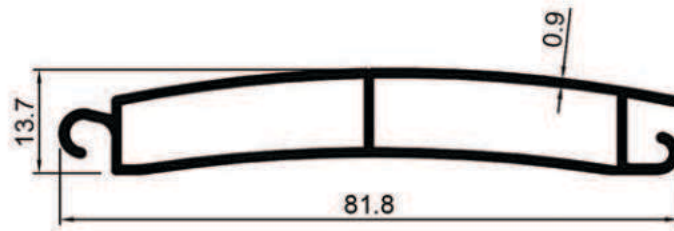

1106

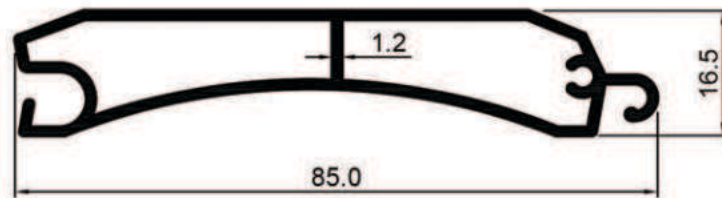

1108

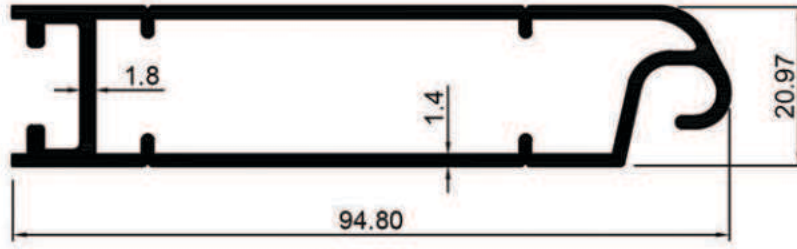

1101

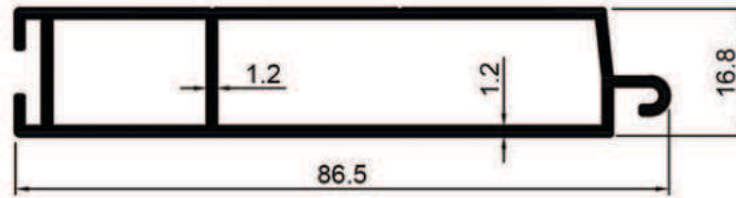

1104

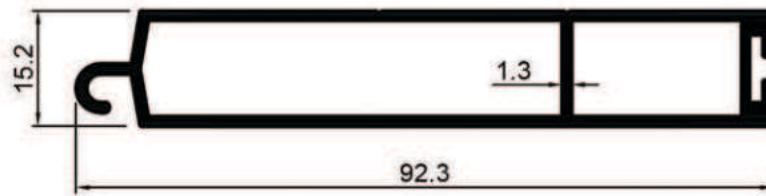

1110

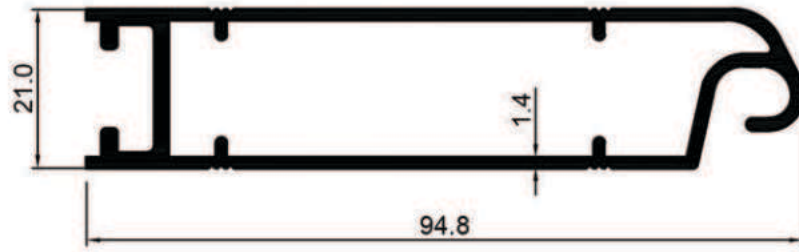

1107

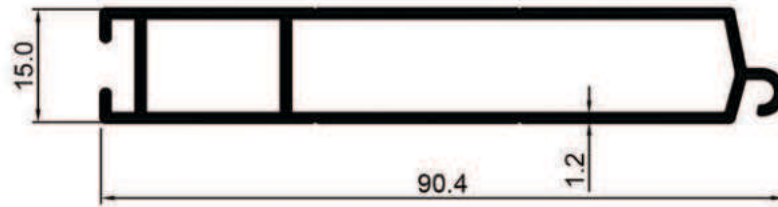

7510



7504

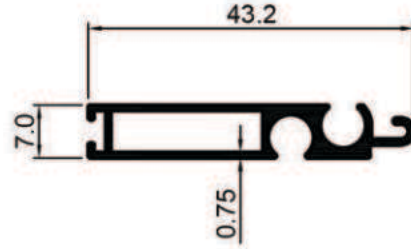

1112

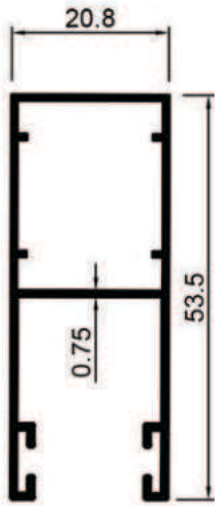

1111

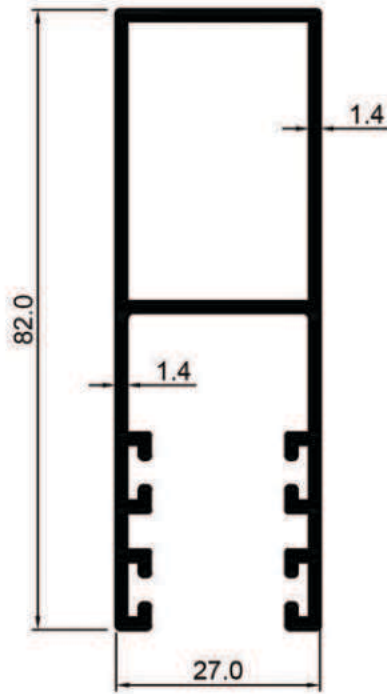

1109

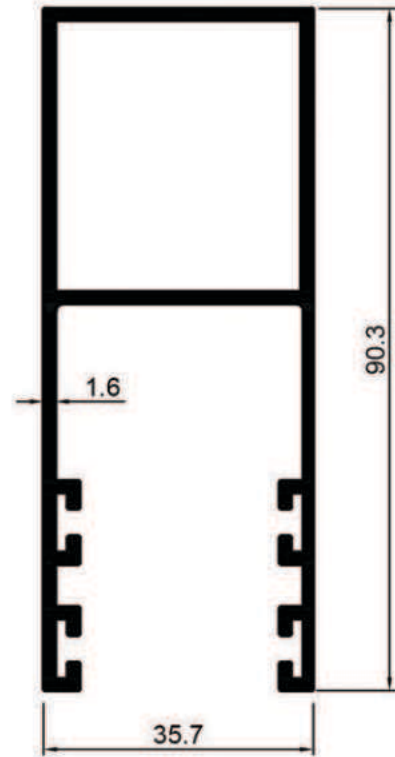

1103

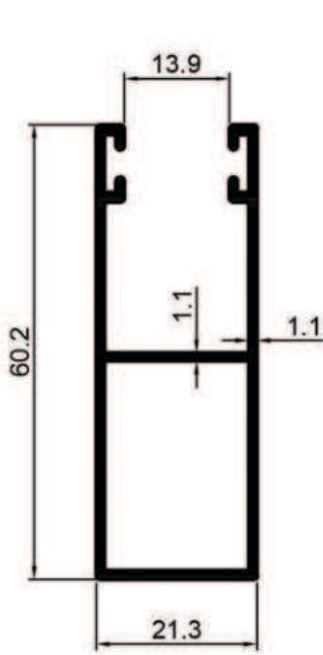

7505

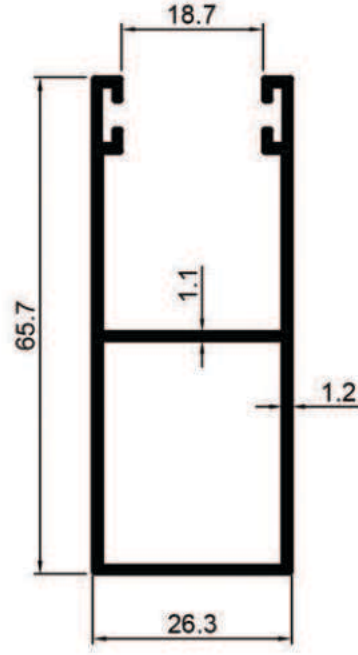

7506

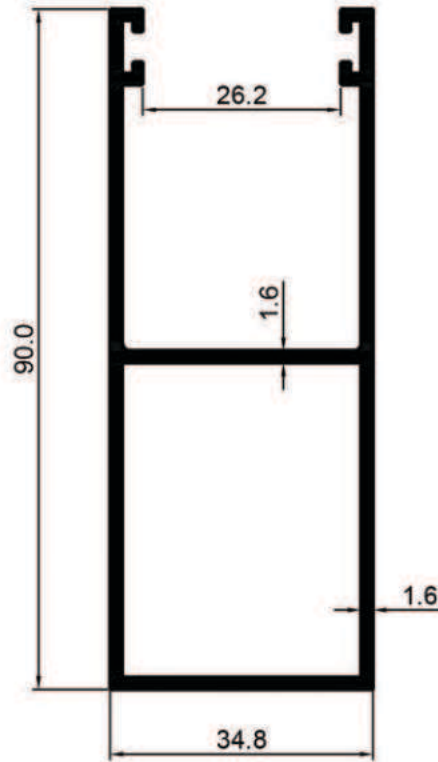

7507

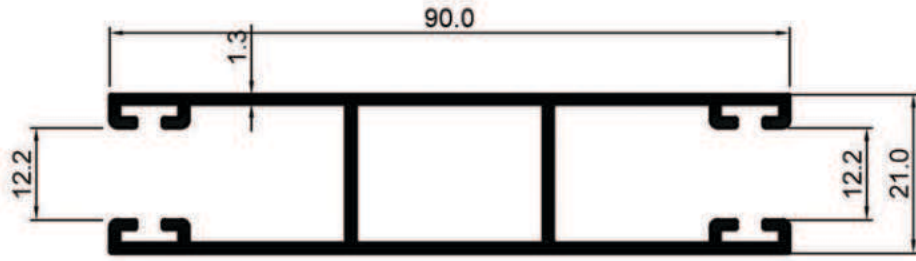

7508

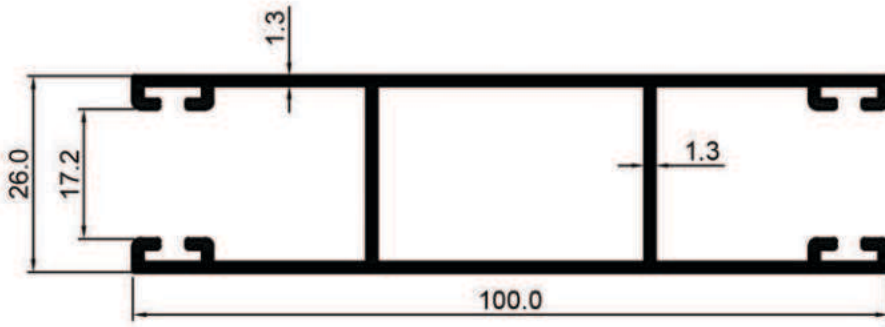

7509

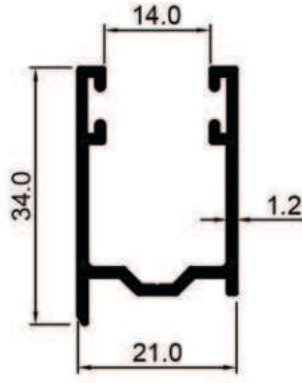

7500

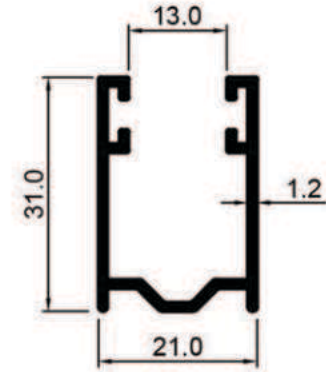

7501

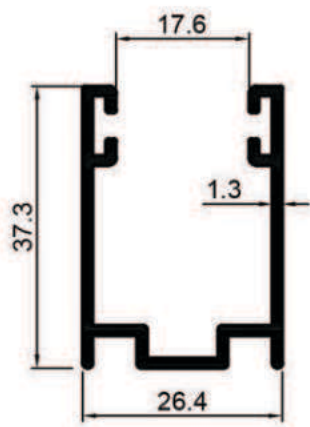

7502

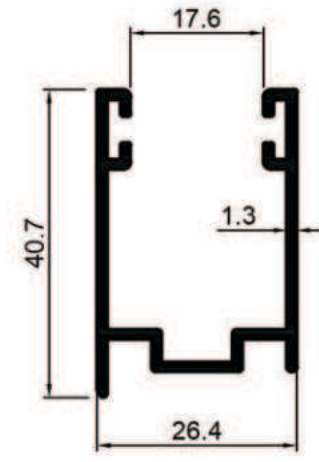

7503



SİNEKLİK PROFİLLERİ

INSECT SCREEN PROFILES



1001

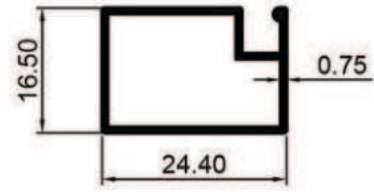

1001-75

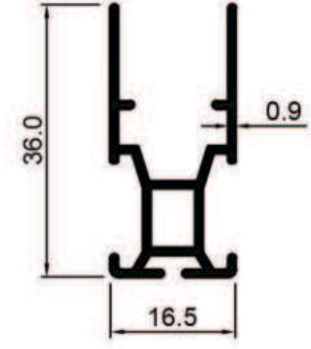

1021

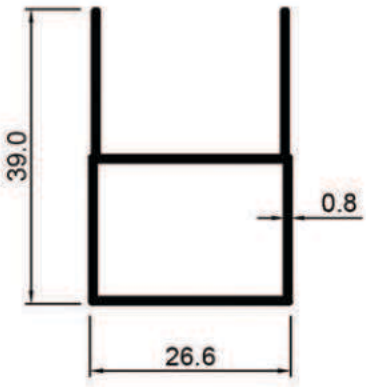

1022

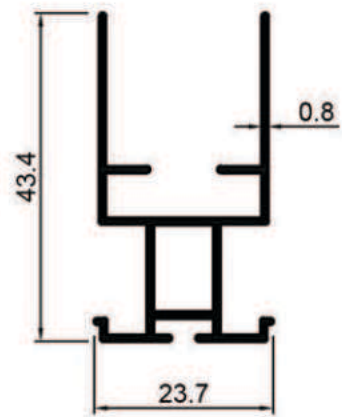

1023

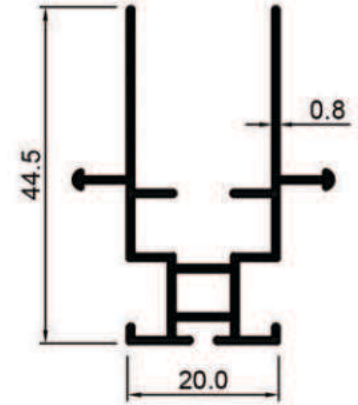

1027

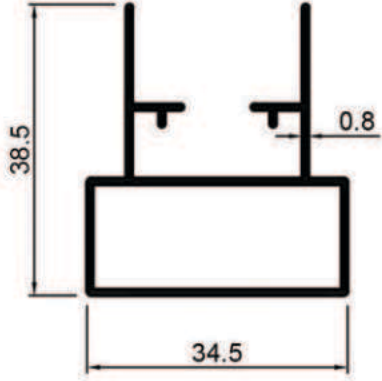

1026

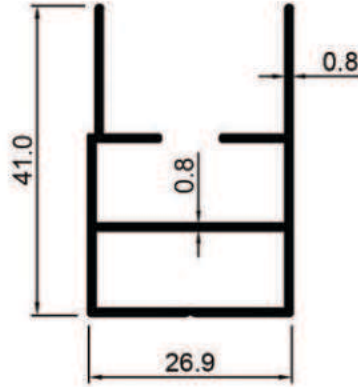

1032

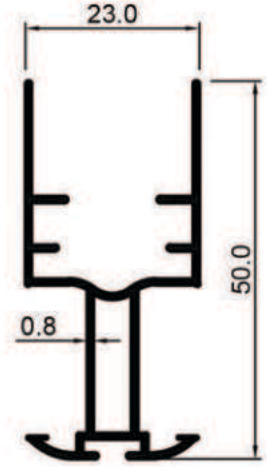

1033

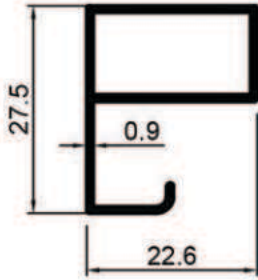

1080



1082

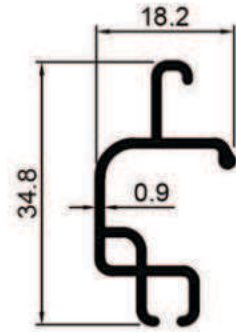

1083

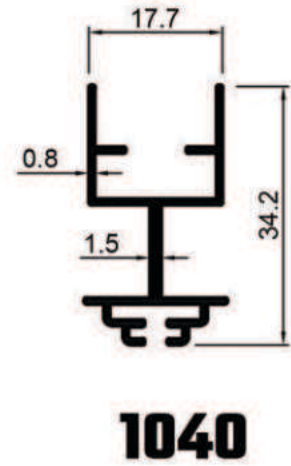
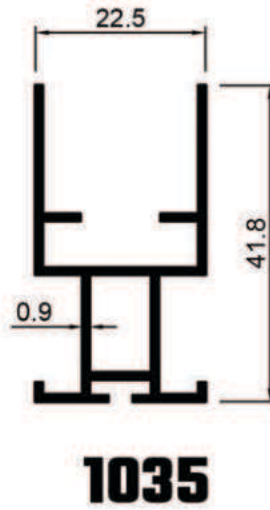
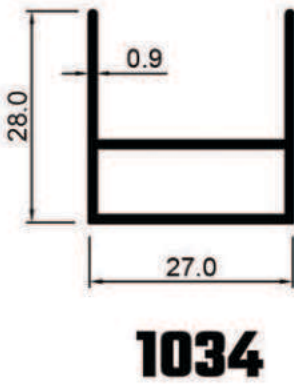
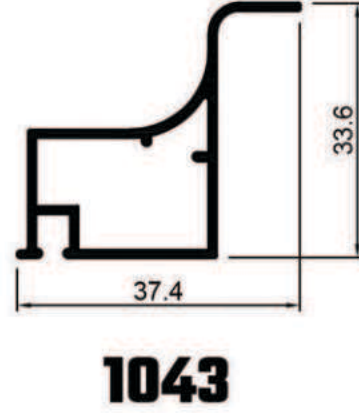
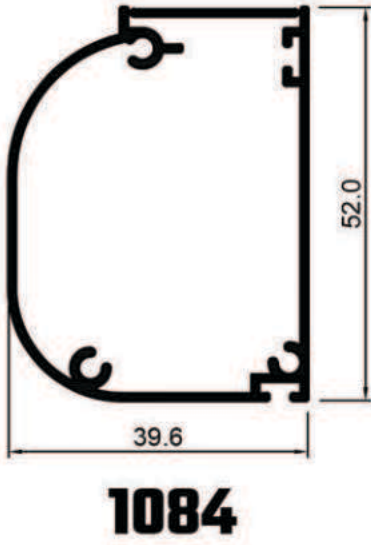

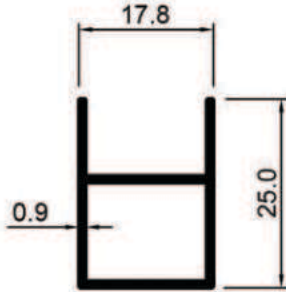

1039

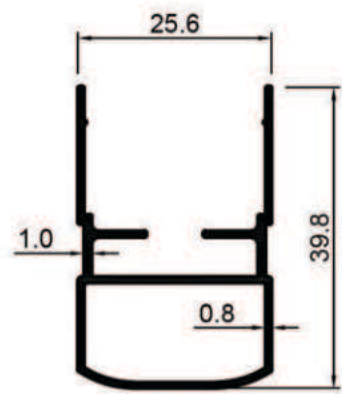

1041

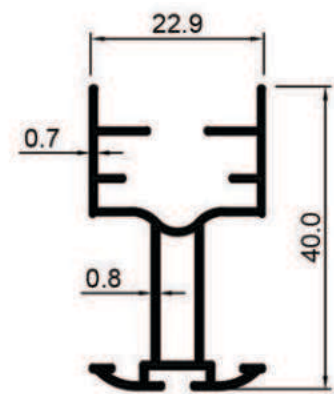

1042

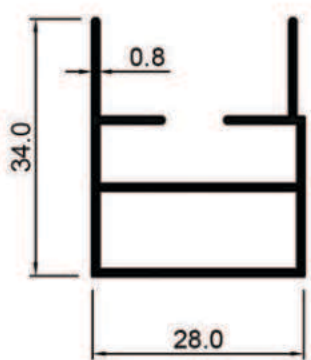

1025

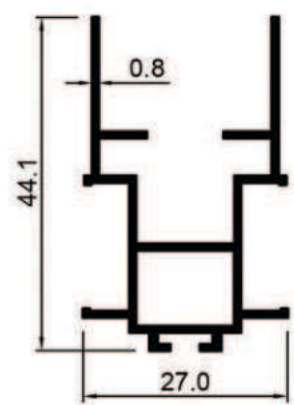

1024

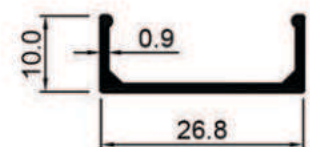

1044

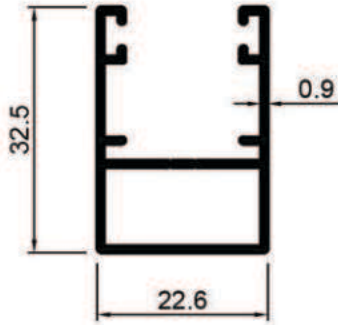

1081

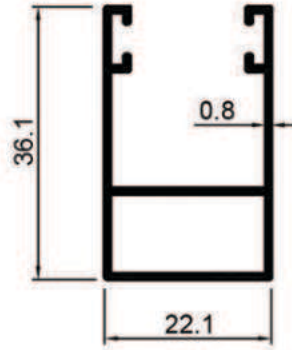

1051

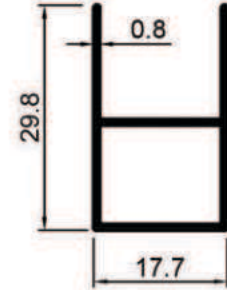

1050

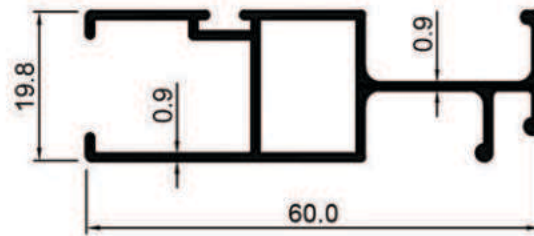

1060

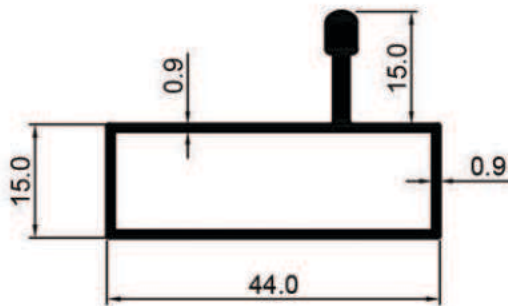

1062

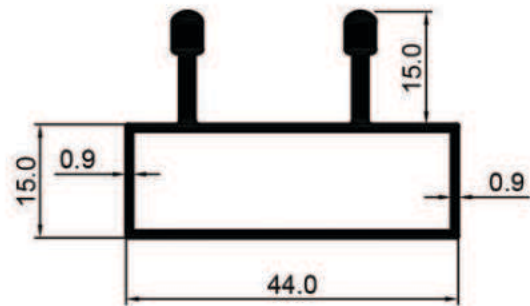

1061

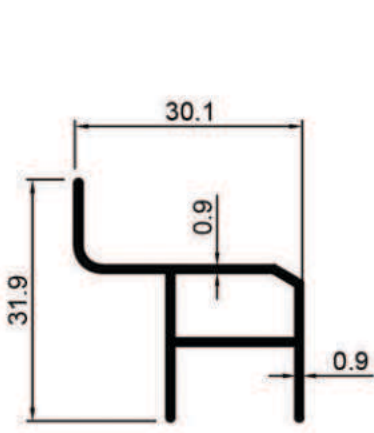

1064

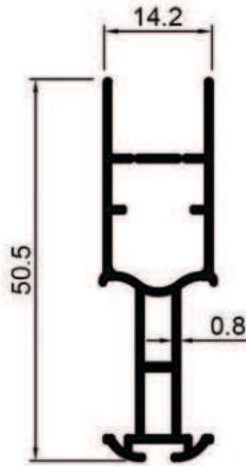

1048

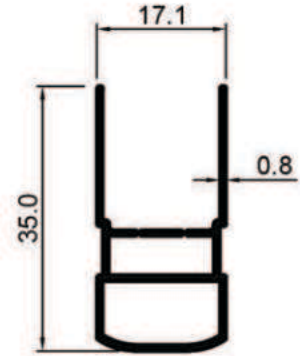

1049

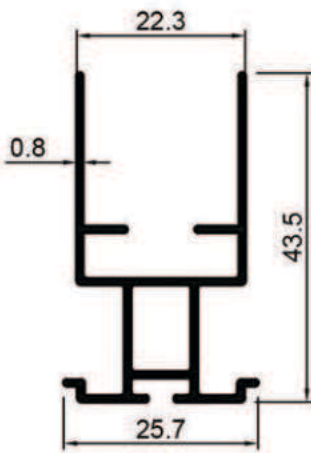

1059

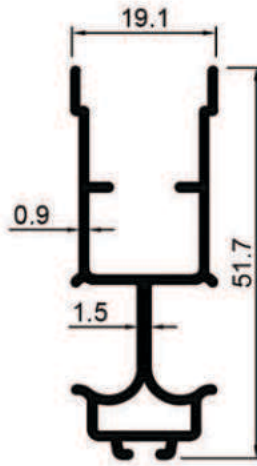

1065

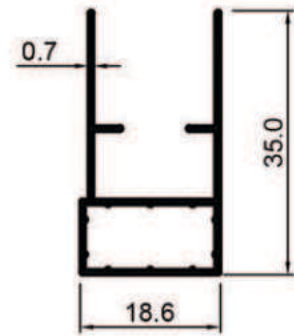

1066

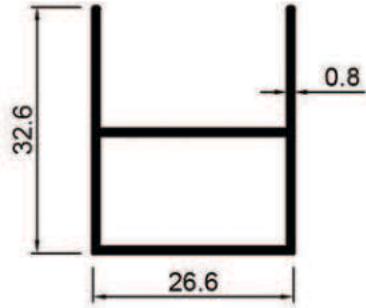

1067

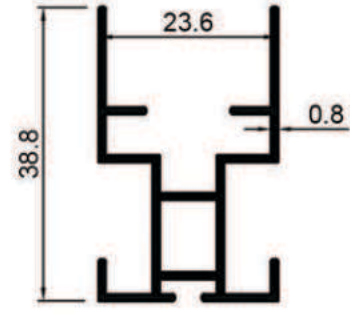

1068

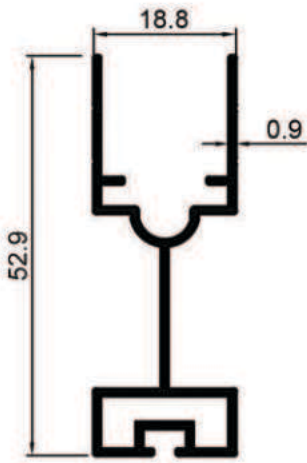

4410

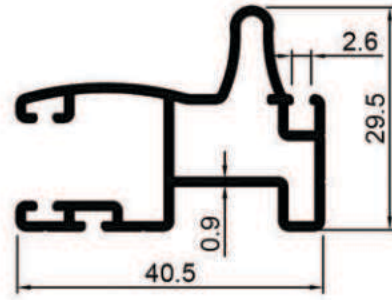

4394

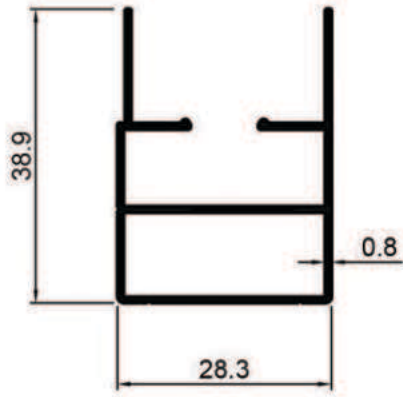

1072

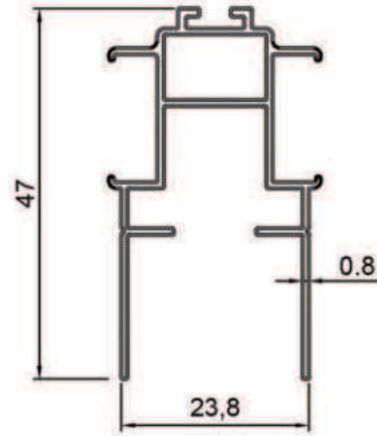

1073

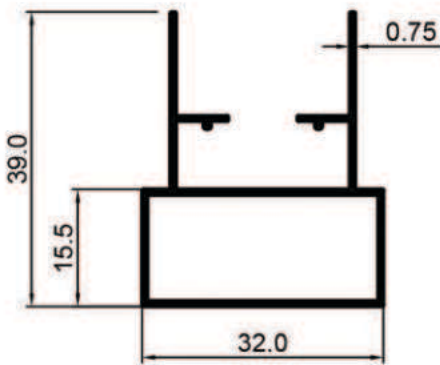

1074

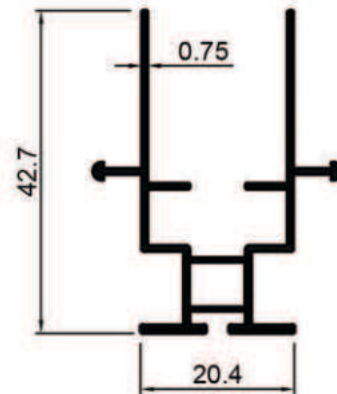

1075



KÜPEŞTE ve KORKULUK PROFİLLERİ

HANDRAIL and RAILING PROFILES

www.regrup.net

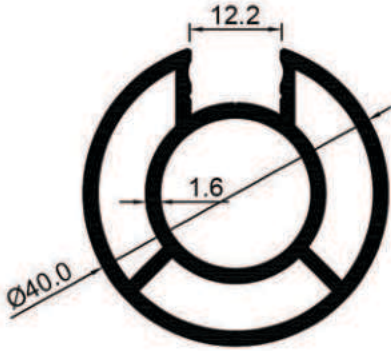

4003

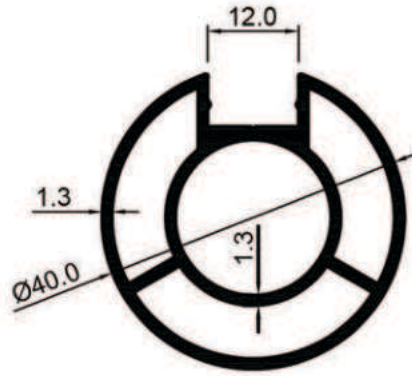

4005

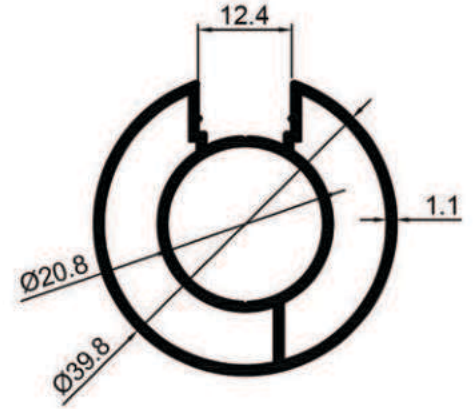

4015

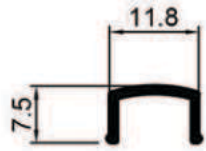

4004

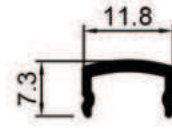

4010

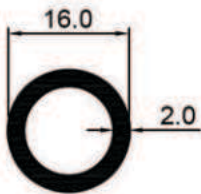

4002

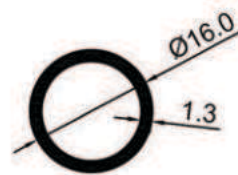

4006

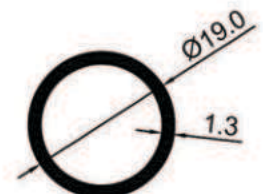

4007

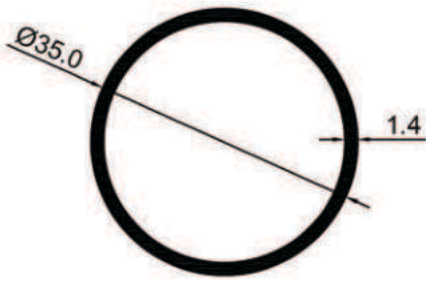

4009

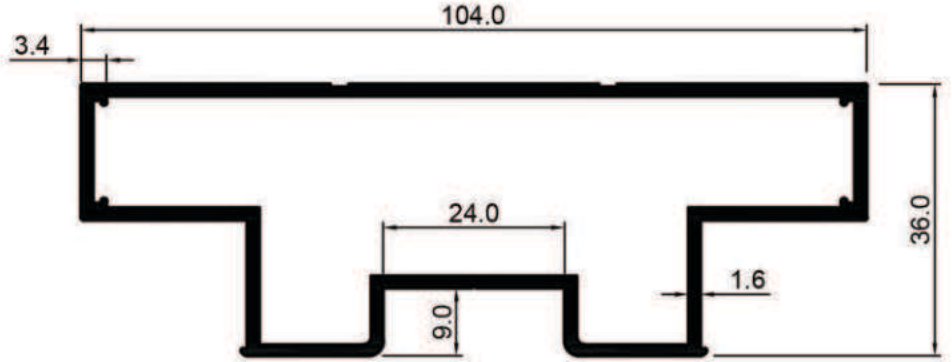

4060

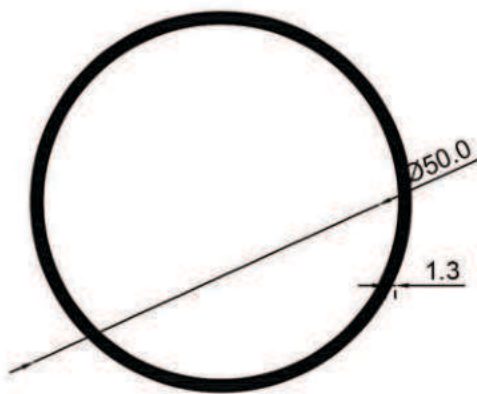

4008

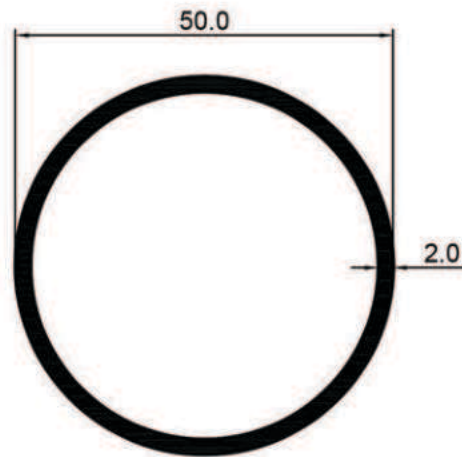

4001



KARE KÜPEŞTE PROFİLLERİ

SQUARE HANDRAIL PROFILES

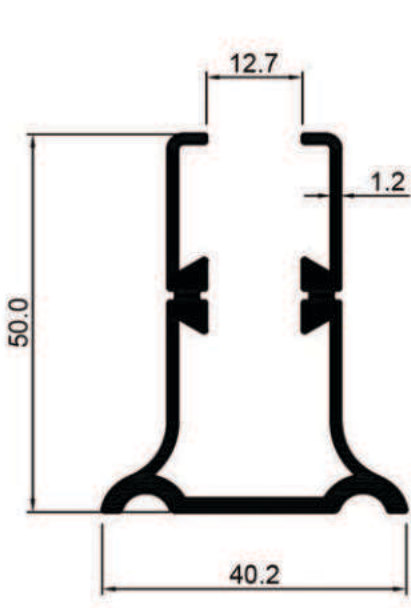

3901

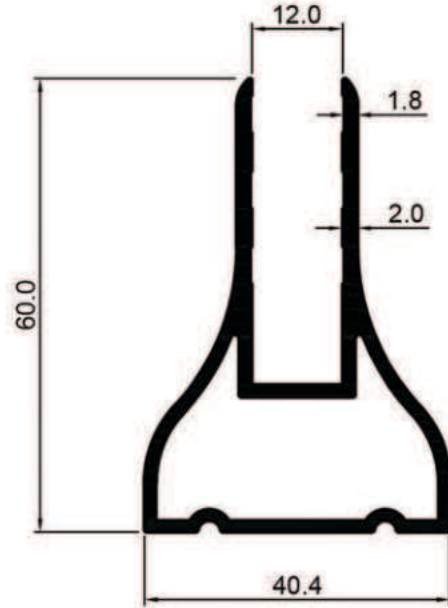

3902

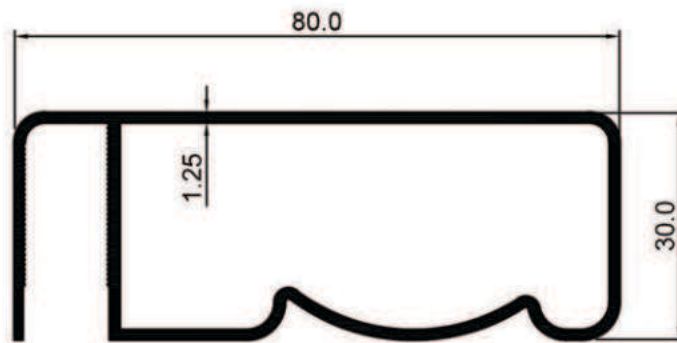

3904

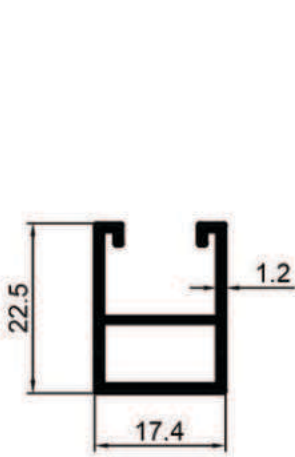

3912

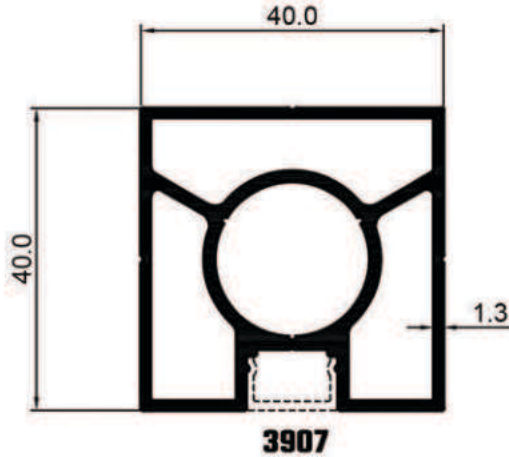

3908

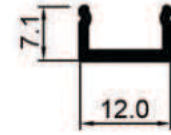

3907

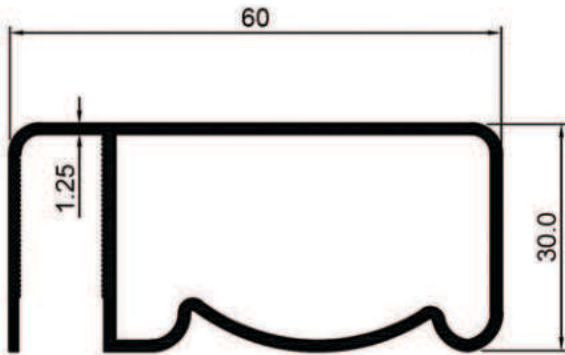

3905

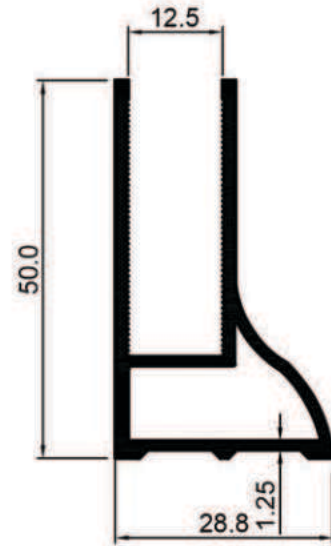

3906

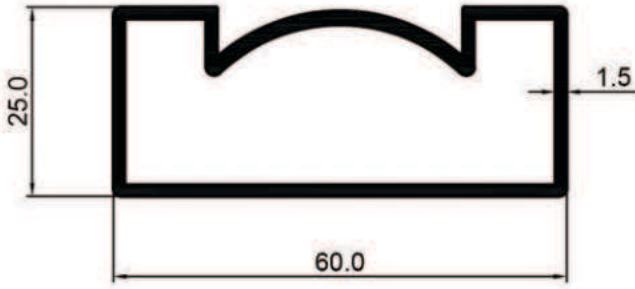

3914

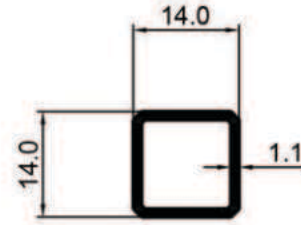

3911

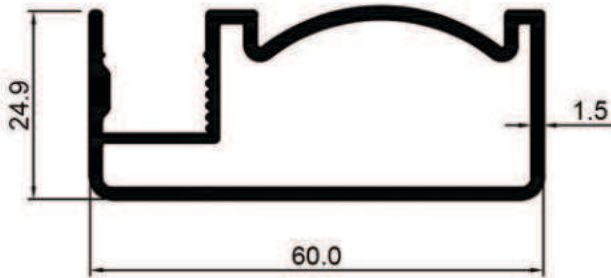

3915

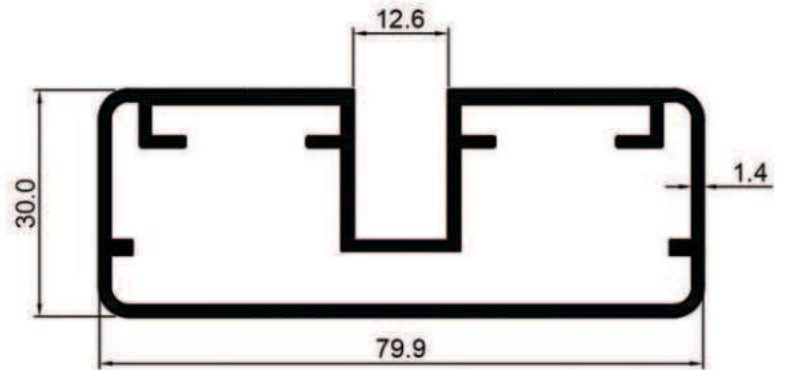

3913

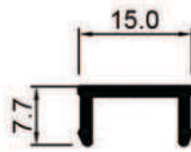

3910

0,090
Kg/m

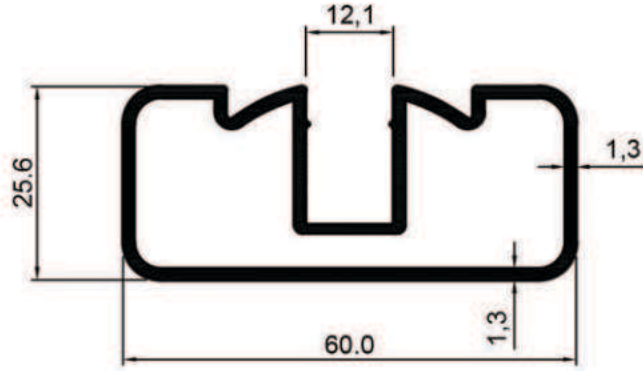

3920

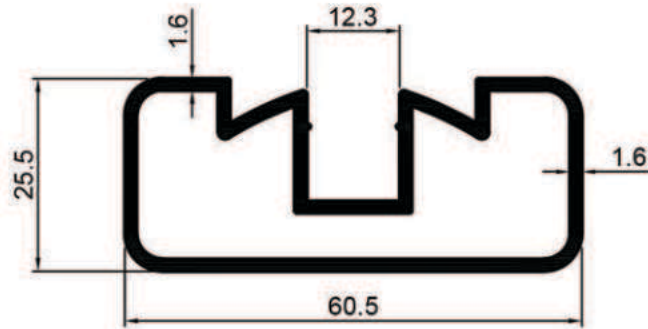

3903



HAREKETLİ KÜPEŞTE PROFİLLERİ

MOVABLE HANDRAIL PROFILES

www.regrup.net

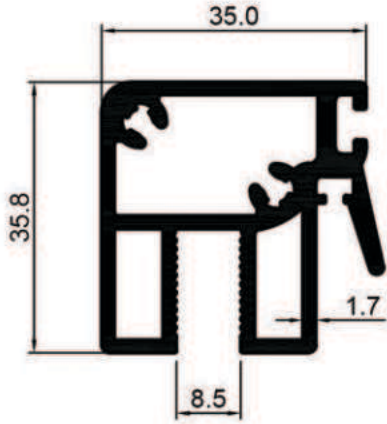

0270

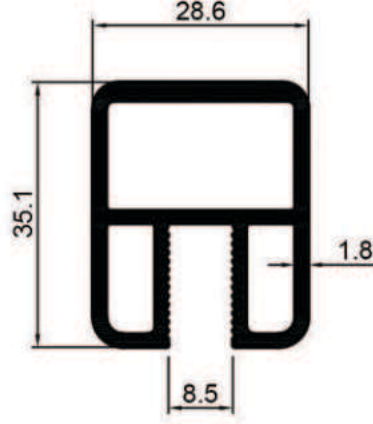

0271

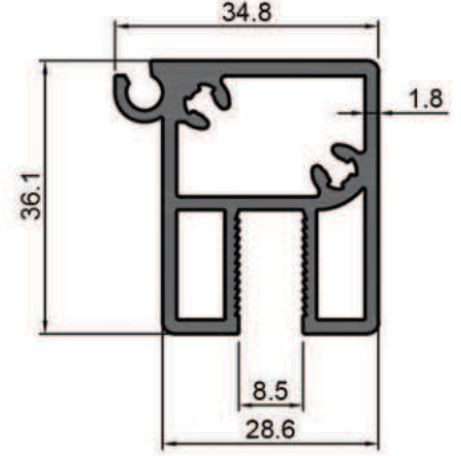

0291

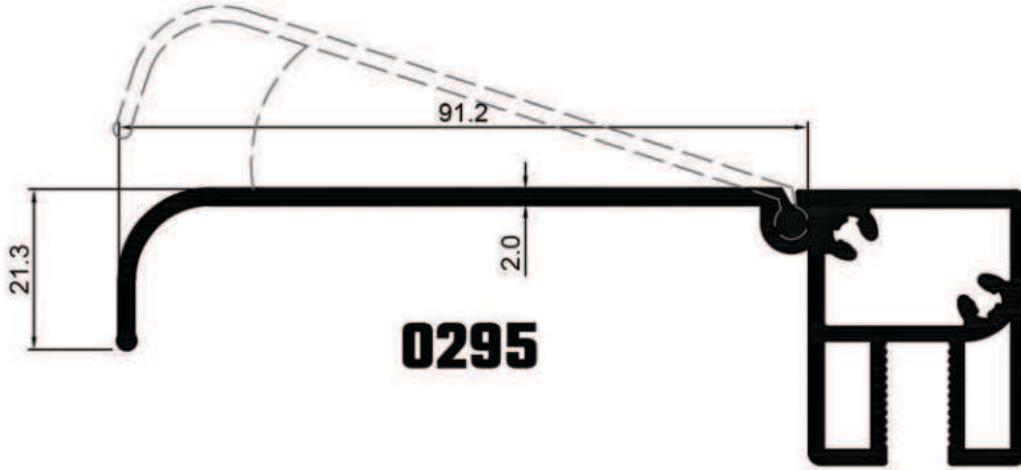

0295

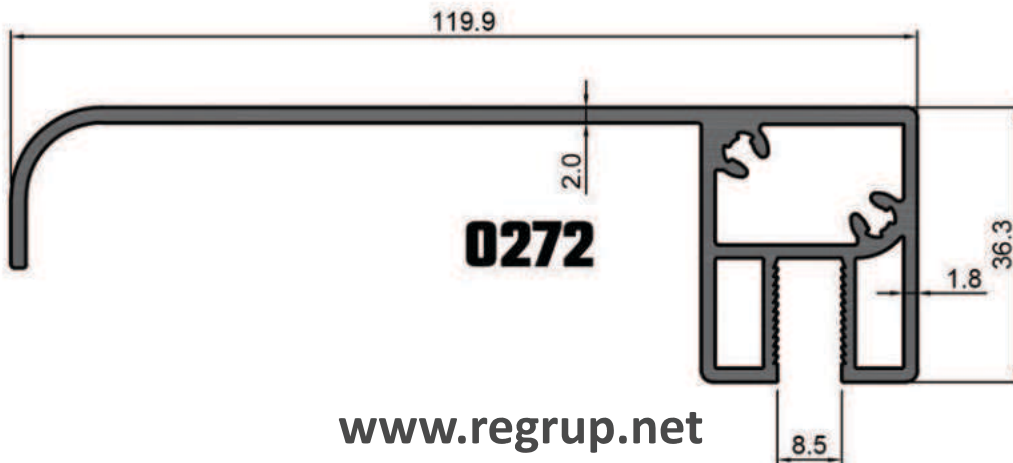

0272

www.regrup.net

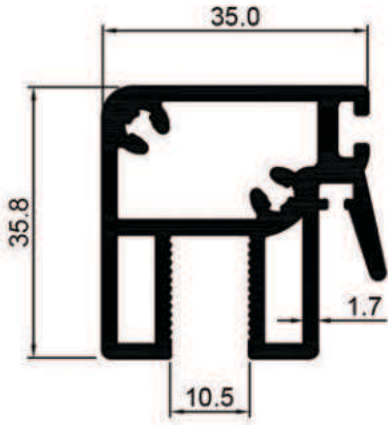

0273

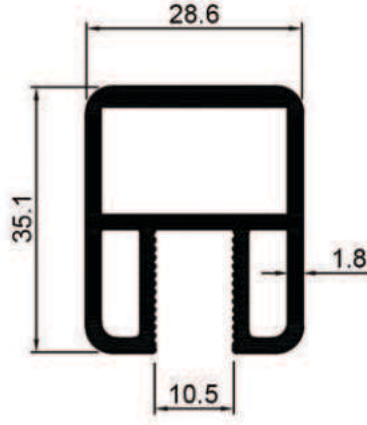

0274

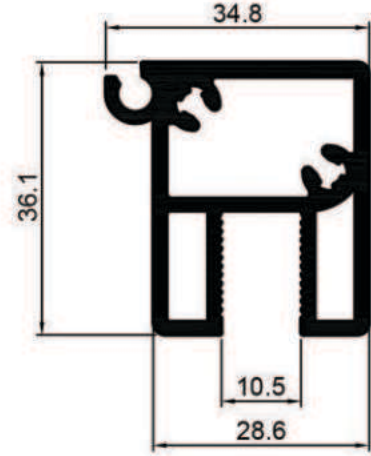

0292

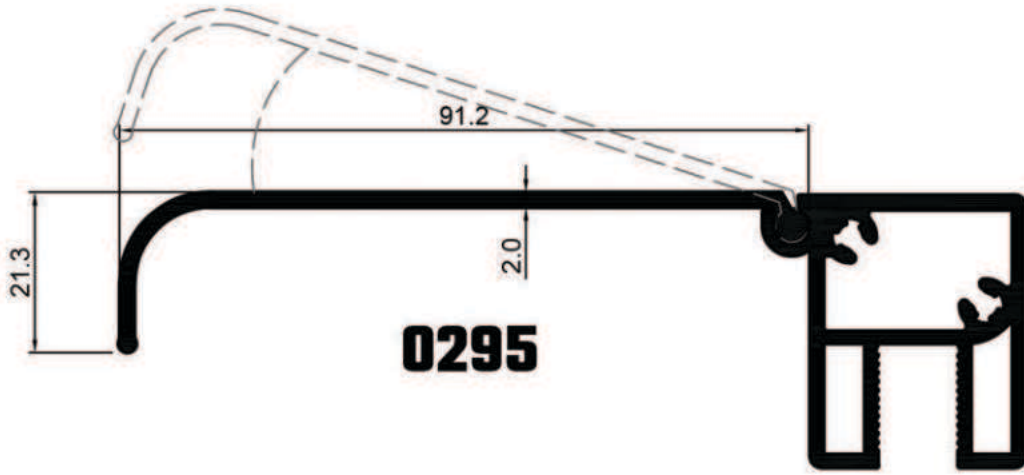

0295

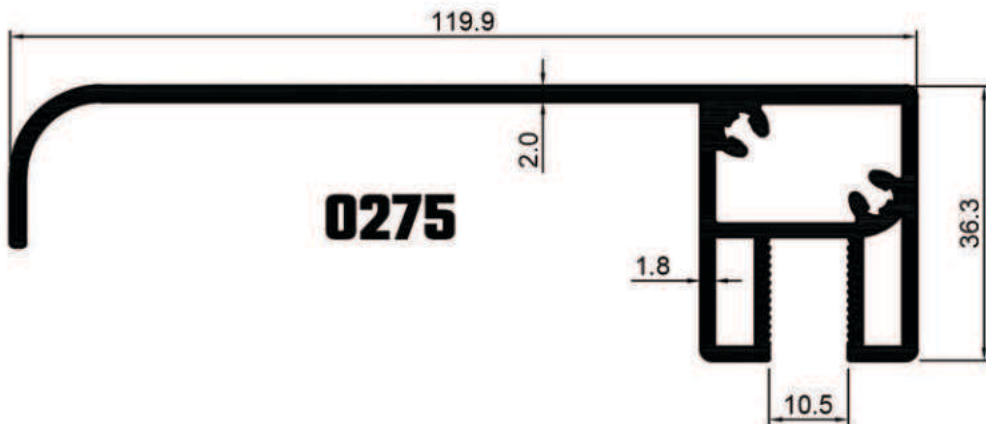

0275

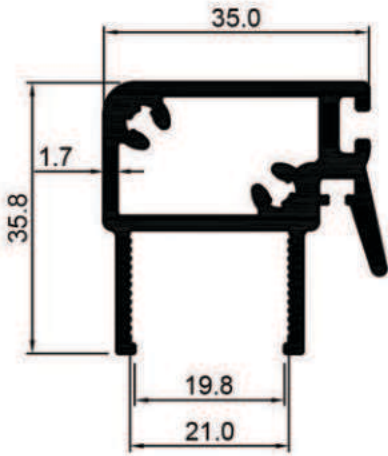

0276

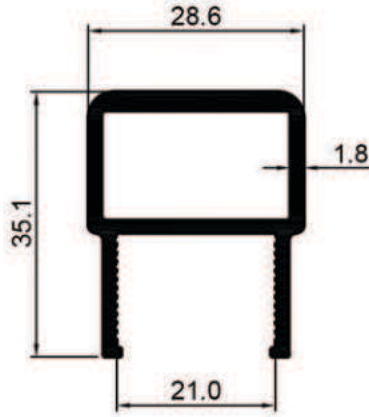

0277

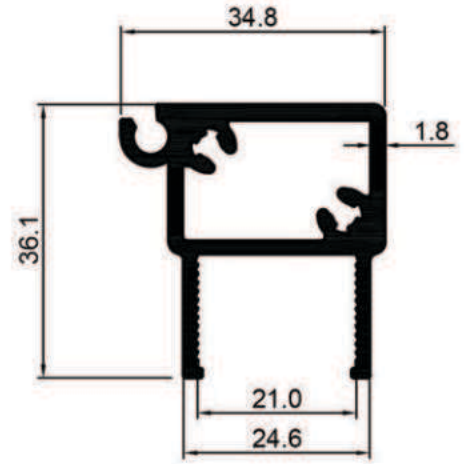

0293

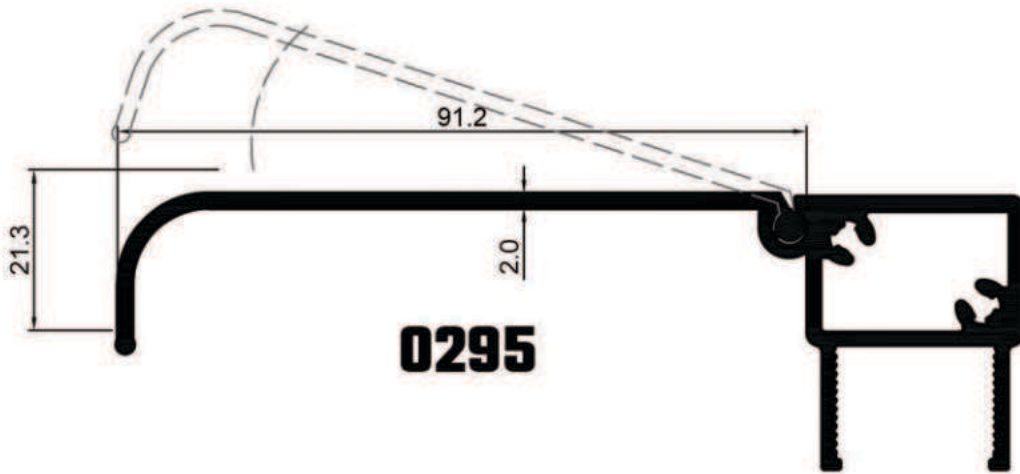

0295

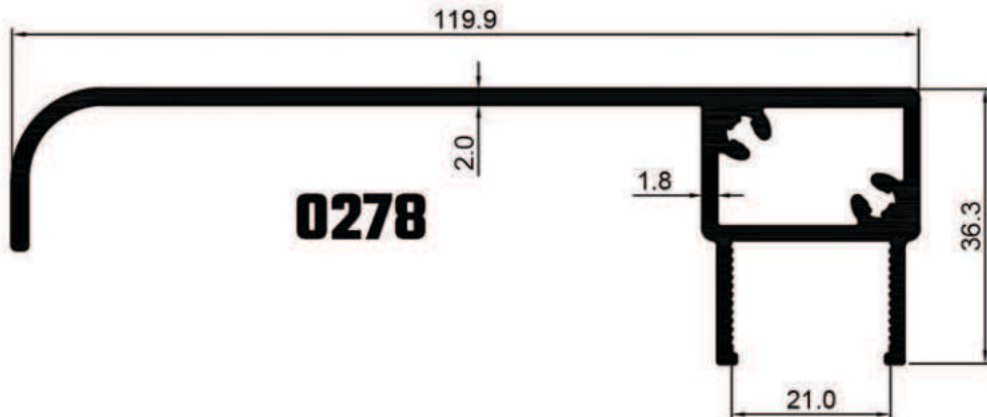

0278

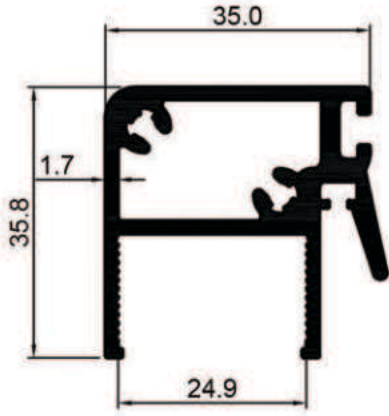

0279

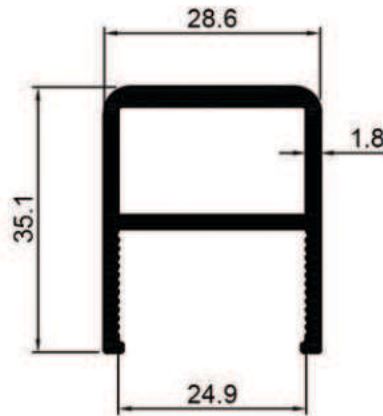

0280

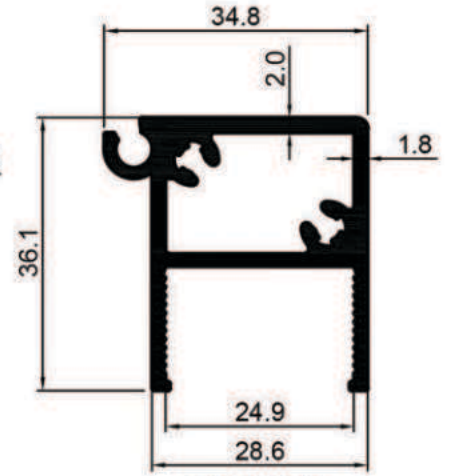

0294

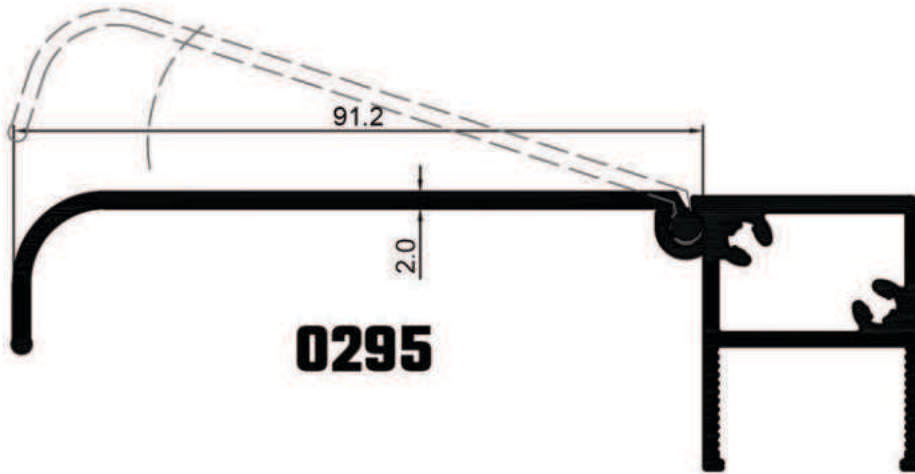

0295

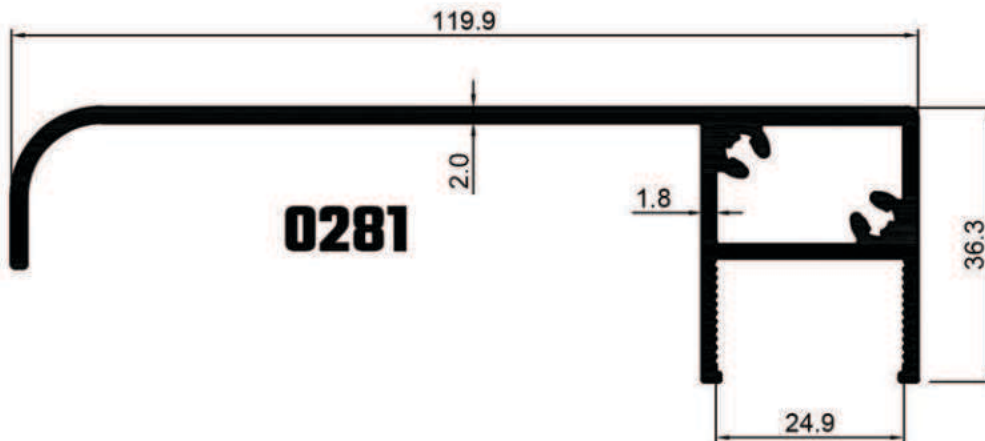

0281

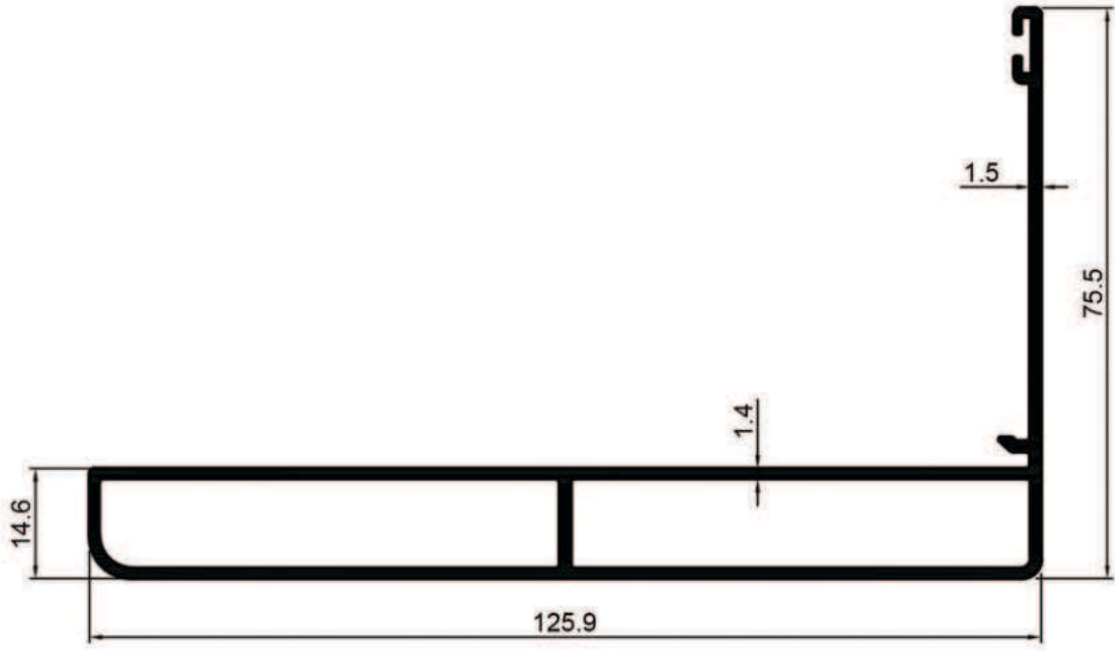

0282

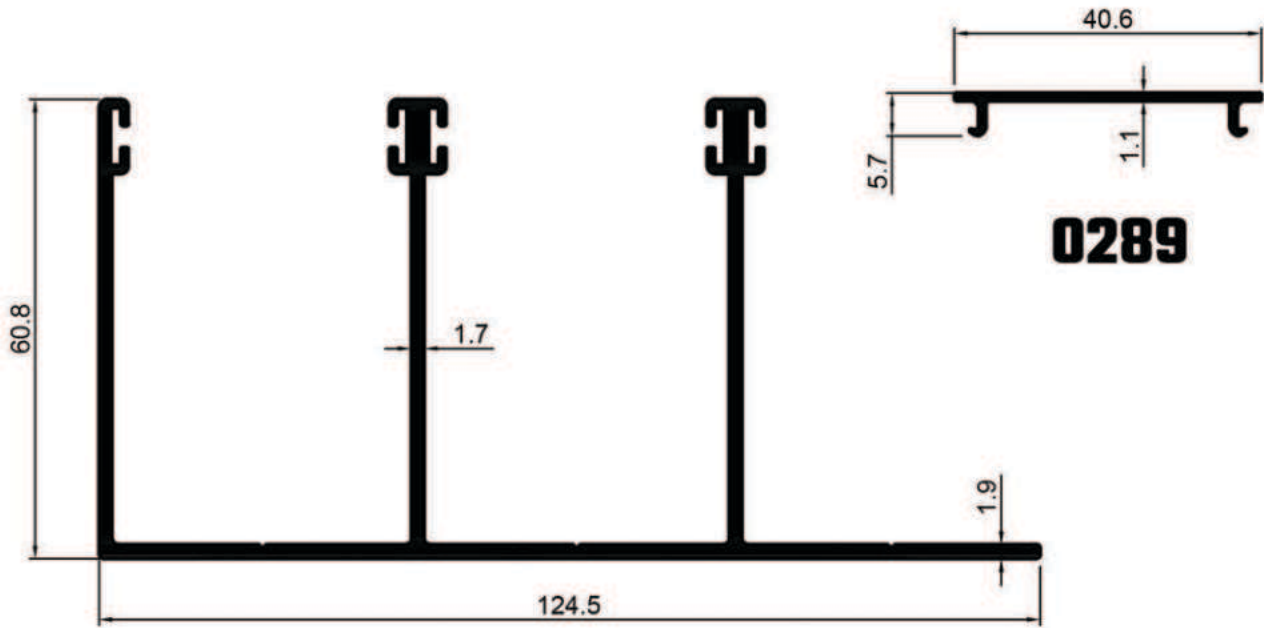

0283

0289

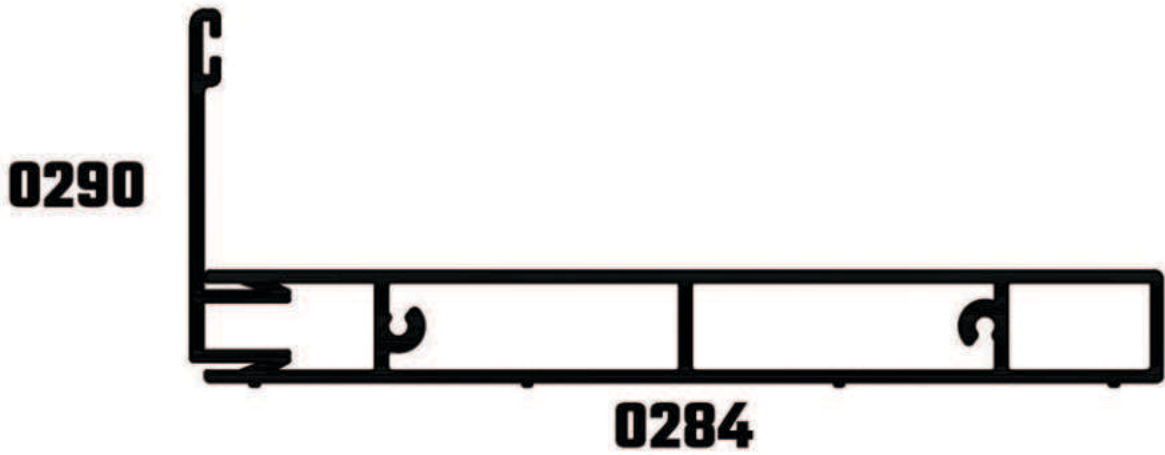
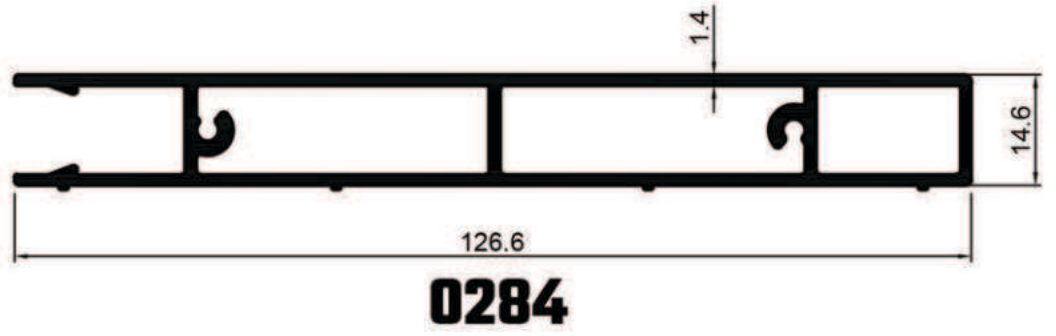

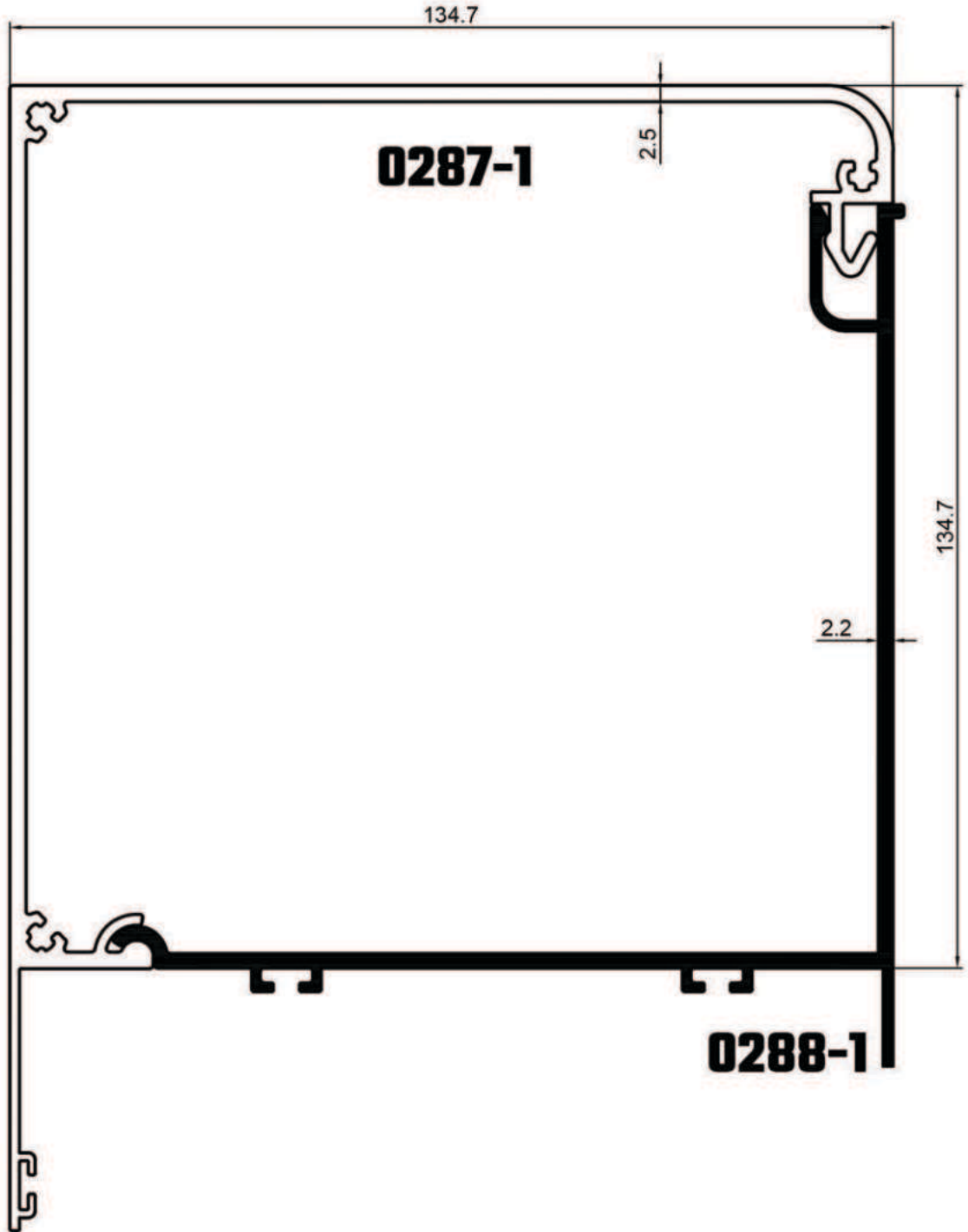

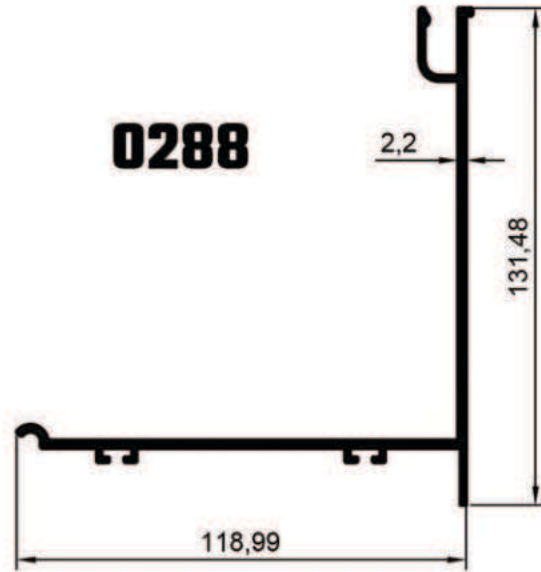
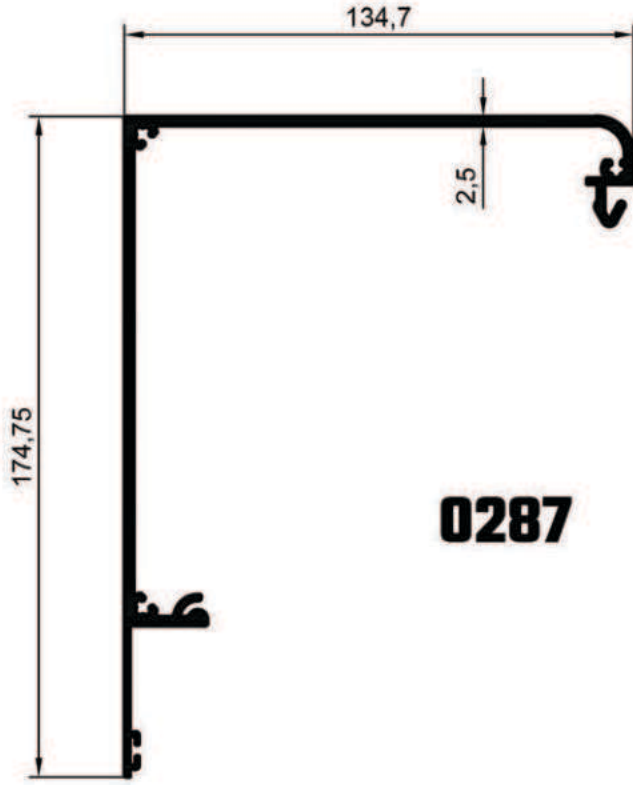

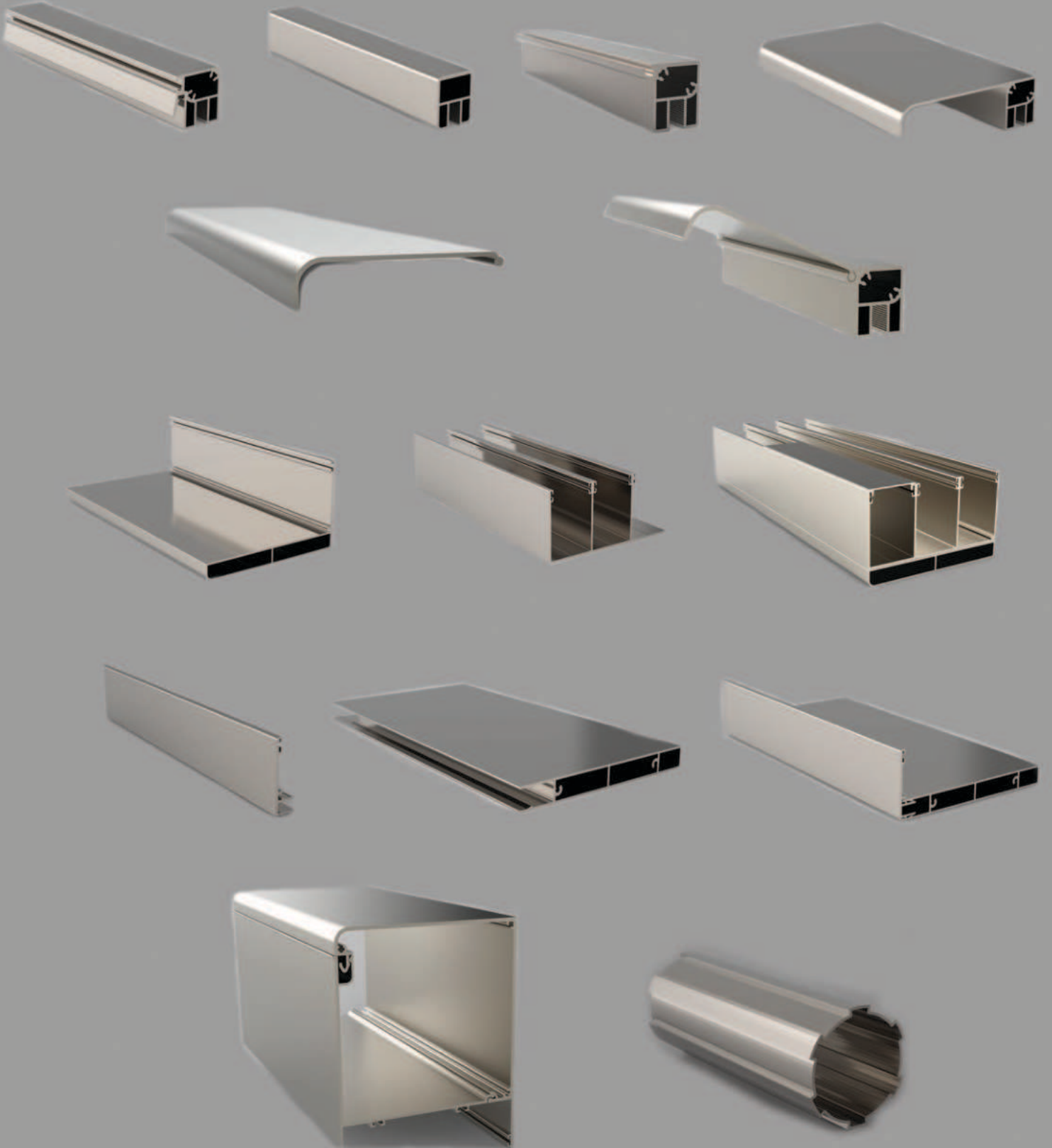

ZİNCİRLİ GİYOTİN AKSESUAR FİYAT LİSTESİ (6 HATVELİ BORU)

ÜRÜN KODU: GZ-02

SET FİYATI: _____

	MALZEME ADI	MİKTAR
	GİYOTİN PLASTİK YAN KAPAK / SAĞ	1 ADET
	GİYOTİN PLASTİK YAN KAPAK / SOL	1 ADET
	GİYOTİN PLASTİK RULMAN YATAĞI	1 ADET
	GİYOTİN RULMANI	1 ADET
	GİYOTİN KASA KÖŞE TAKOZU	2 ADET
	GİYOTİN KANAT BİRLEŞTİRME KÖŞE TAKOZU-SAĞ	6 ADET
	GİYOTİN KANAT BİRLEŞTİRME KÖŞE TAKOZU-SOL	6 ADET
	MAKARA / SAĞ	6 ADET
	MAKARA / SOL	6 ADET
	GİYOTİN KÜPEŞTE YAN PLASTİĞİ / SAĞ	1 ADET
	GİYOTİN KÜPEŞTE YAN PLASTİĞİ / SOL	1 ADET
	GİYOTİN DİŞLİSİ ÇENTİKLİ (ZİNCİRLİ İÇİN)	2 ADET
	GİYOTİN PLASTİK TRİGER KASNAĞI 6 HATVELİ	2 ADET
	GİYOTİN TAMBUR BAŞI (SEKİZ KÖŞE)	1 ADET
	GİYOTİN ZİNCİR BOĞMA APARATI	2 ADET
	ZİNCİR BAĞLAMA APARATI	2 ADET
	ZİNCİR 08-B1 (5 MT)	1 PAKET
	GİYOTİN ZİNCİR MAKARASI	2 ADET

ZİNCİRLİ GİYOTİN AKSESUAR SETİ

(8 KÖŞE ALÜMİNYUM VE GALVANİZ BORULU)

ÜRÜN KODU: GZ-01

SET FİYATI: _____

MALZEME ADI

MİKTAR

	GİYOTİN PLASTİK YAN KAPAK / SAĞ	1 ADET
	GİYOTİN PLASTİK YAN KAPAK / SOL	1 ADET
	GİYOTİN PLASTİK RULMAN YATAĞI	1 ADET
	GİYOTİN RULMANI	1 ADET
	GİYOTİN KASA KÖŞE TAKOZU	2 ADET
	GİYOTİN KANAT BİRLEŞTİRME KÖŞE TAKOZU-SAĞ	6 ADET
	GİYOTİN KANAT BİRLEŞTİRME KÖŞE TAKOZU-SOL	6 ADET
	MAKARA / SAĞ	6 ADET
	MAKARA / SOL	6 ADET
	GİYOTİN KÜPEŞTE YAN PLASTİĞİ / SAĞ	1 ADET
	GİYOTİN KÜPEŞTE YAN PLASTİĞİ / SOL	1 ADET
	GİYOTİN DIŞLISI SEKİZ KÖŞE	2 ADET
	GİYOTİN TAMBUR BAŞI (SEKİZ KÖŞE)	1 ADET
	GİYOTİN ZİNCİR BOĞMA APARATI	2 ADET
	ZİNCİR BAĞLAMA APARATI	2 ADET
	ZİNCİR 08-B1 (5 MT)	1 PAKET
	GİYOTİN ZİNCİR MAKARASI	2 ADET

TRİGERLİ GİYOTİN AKSESUAR FİYAT LİSTESİ

(8 KÖŞE ALÜMİNYUM VE GALVANİZ BORULU)

ÜRÜN KODU: GT - 01

SET FİYATI: _____

	MALZEME ADI	MİKTAR
	GİYOTİN PLASTİK YAN KAPAK SAĞ	1 ADET
	GİYOTİN PLASTİK YAN KAPAK SOL	1 ADET
	GİYOTİN PLASTİK RULMAN YATAĞI	1 ADET
	GİYOTİN RULMANI	1 ADET
	GİYOTİN KASA KÖŞE TAKOZU	2 ADET
	GİYOTİN KANAT BİRLEŞTİRME KÖŞE TAKOZU-SAĞ	6 ADET
	GİYOTİN KANAT BİRLEŞTİRME KÖŞE TAKOZU-SOL	6 ADET
	MAKARA SAĞ	6 ADET
	MAKARA SOL	6 ADET
	GİYOTİN KÜPEŞTE YAN PLASTİĞİ SAĞ	1 ADET
	GİYOTİN KÜPEŞTE YAN PLASTİĞİ SOL	1 ADET
	GİYOTİN TRİGER KAYIŞ T2 20 MM	5,5 METRE
	GİYOTİN PLASTİK TRİGER KASNAĞI	2 ADET
	GİYOTİN TAMBUR BAŞI SEKİZ KÖŞE (ALÜMİNYUM DÖKÜM)	1 ADET
	TRİGER BAĞLANTI APARATI	2 ADET
	TRİGER BAĞLANTI KAMASI	2 ADET

TRİGERLİ GİYOTİN AKSESUAR FİYAT LİSTESİ

(6 HATVELİ ALÜMİNYUM BORU)

ÜRÜN KODU: GT - 02

SET FİYATI: _____

MALZEME ADI

SET ADETİ

	GİYOTİN PLASTİK YAN KAPAK SAĞ	1 ADET
	GİYOTİN PLASTİK YAN KAPAK SOL	1 ADET
	GİYOTİN PLASTİK RULMAN YATAĞI	1 ADET
	GİYOTİN RULMANI	1 ADET
	GİYOTİN KASA KÖŞE TAKOZU	2 ADET
	GİYOTİN KANAT BİRLEŞTİRME KÖŞE TAKOZU-SAĞ	6 ADET
	GİYOTİN KANAT BİRLEŞTİRME KÖŞE TAKOZU-SOL	6 ADET
	MAKARA SAĞ	6 ADET
	MAKARA SOL	6 ADET
	GİYOTİN KÜPEŞTE YAN PLASTİĞİ SAĞ	1 ADET
	GİYOTİN KÜPEŞTE YAN PLASTİĞİ SOL	1 ADET
	GİYOTİN TRİGER KAYIŞ T2 20 MM (5,5 METRE)	5,5 METRE
	GİYOTİN PLASTİK TRİGER KASNAĞI	2 ADET
	GİYOTİN TAMBUR BAŞI SEKİZ KÖŞE (ALÜMİNYUM DÖKÜM)	1 ADET
	TRİGER BAĞLANTI APARATI	2 ADET
	TRİGER BAĞLANTI KAMASI	2 ADET
	GIYOTIN ZINCIR MAKARASI	2 ADET



PERGOLA PROFİL SİSTEMLERİ

PERGOLA PROFILE SYSTEMS

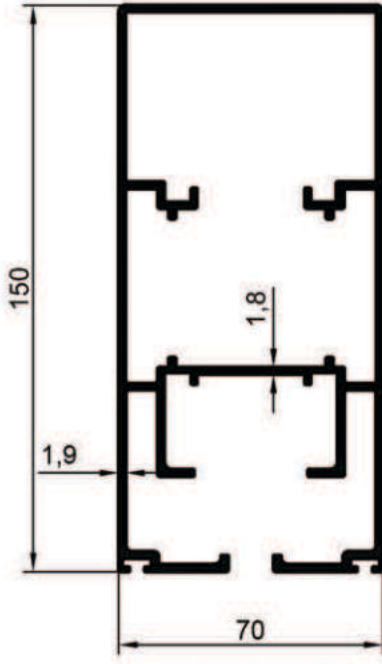

0229

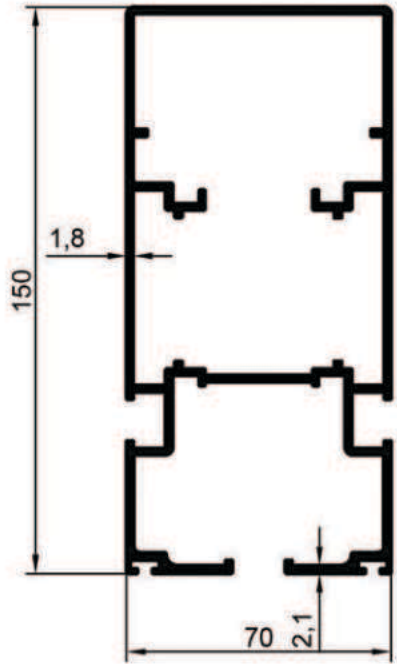

0228

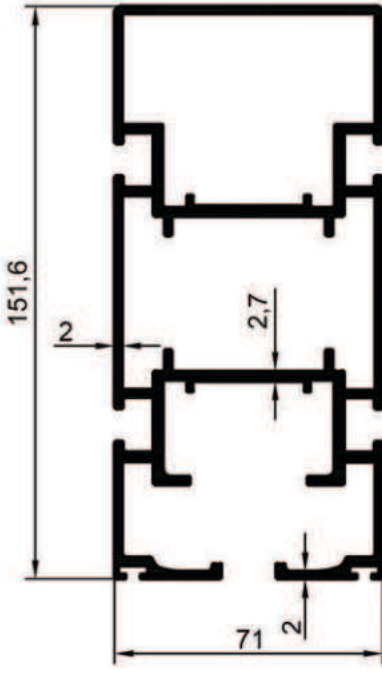

0222

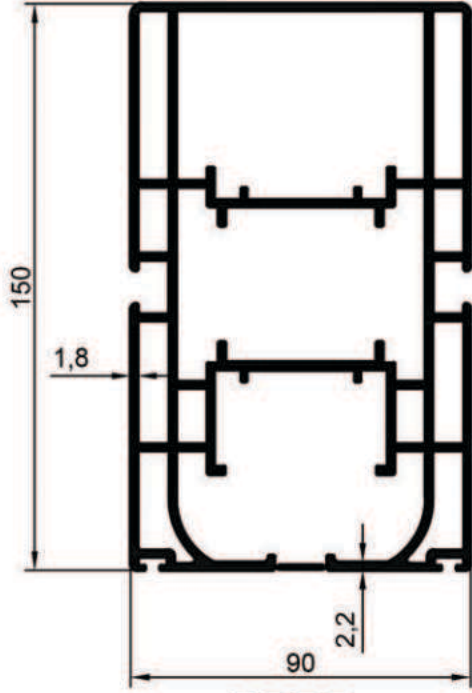

0223

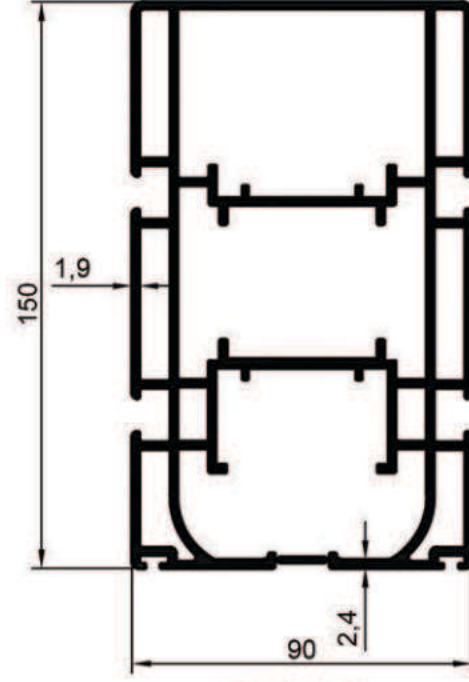

0224

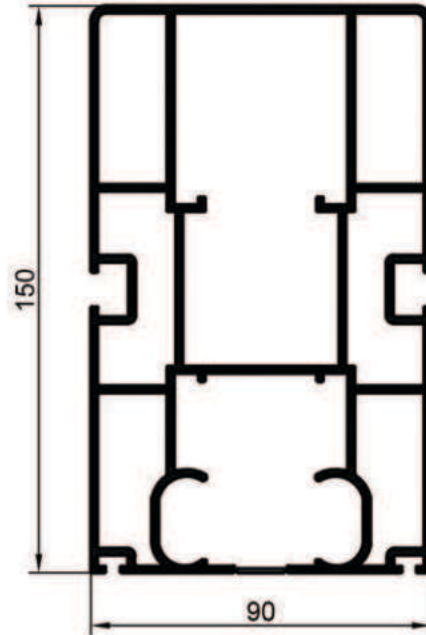

0234

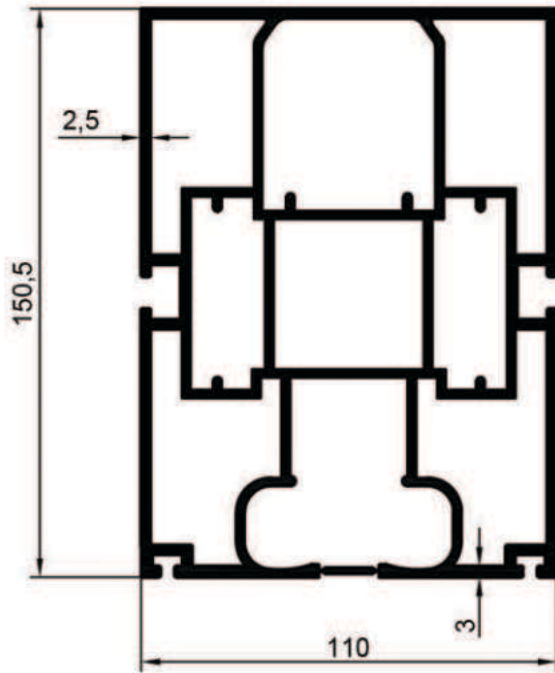

0137

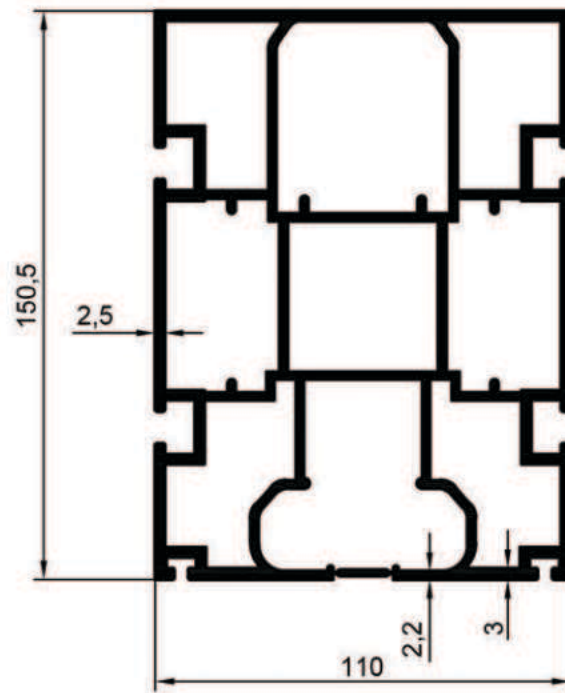

0138

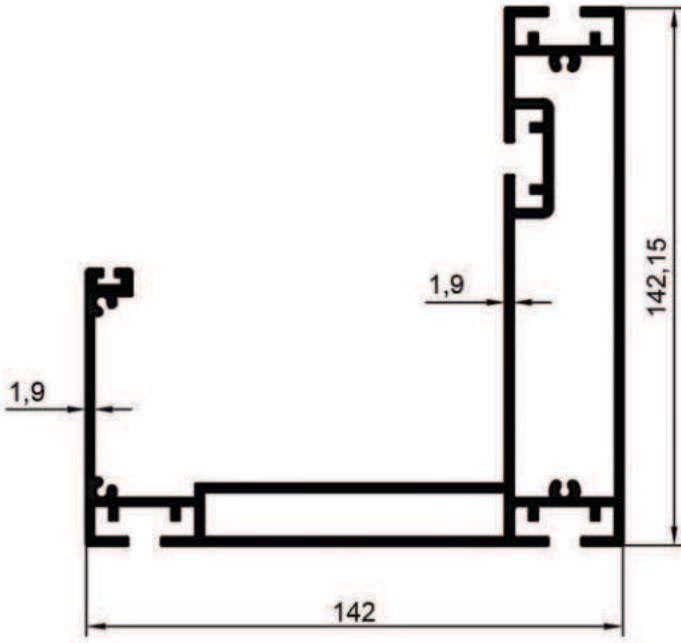

0220



0227

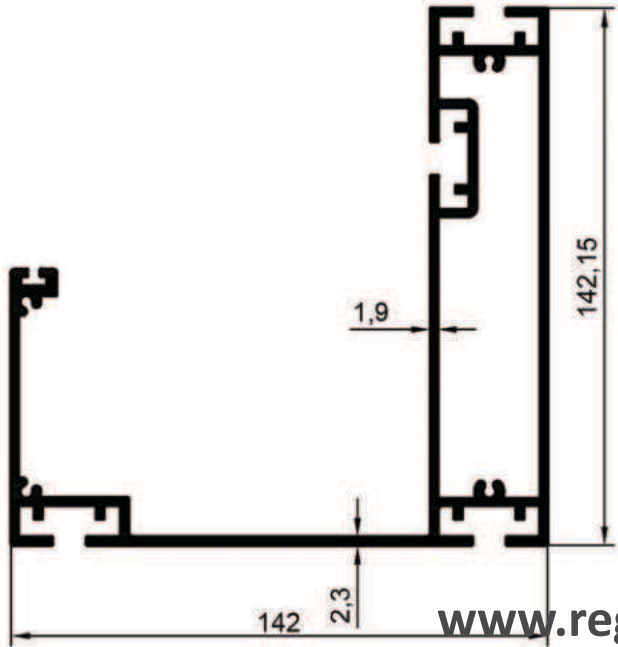

0221

www.regrup.net

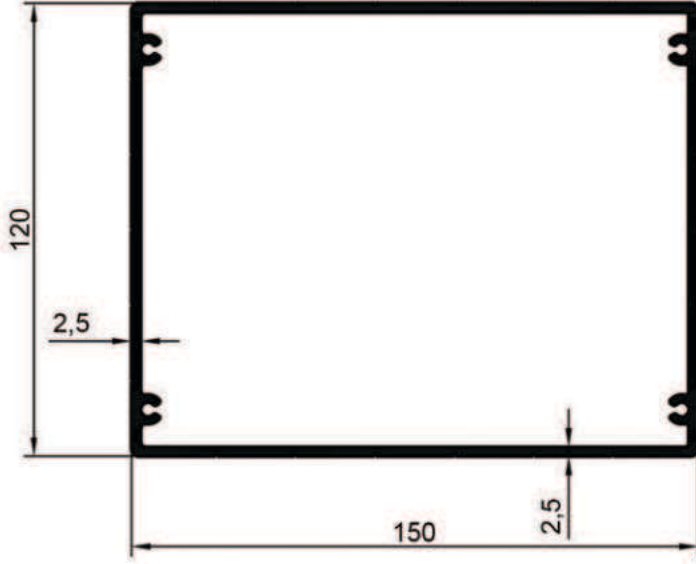

0132

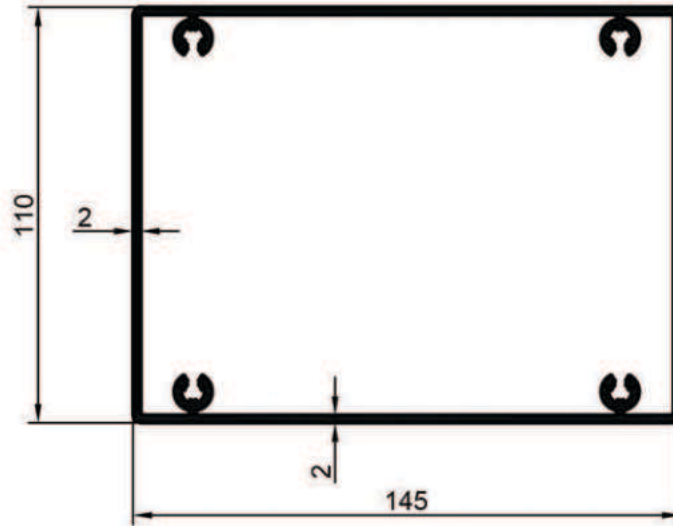

0166

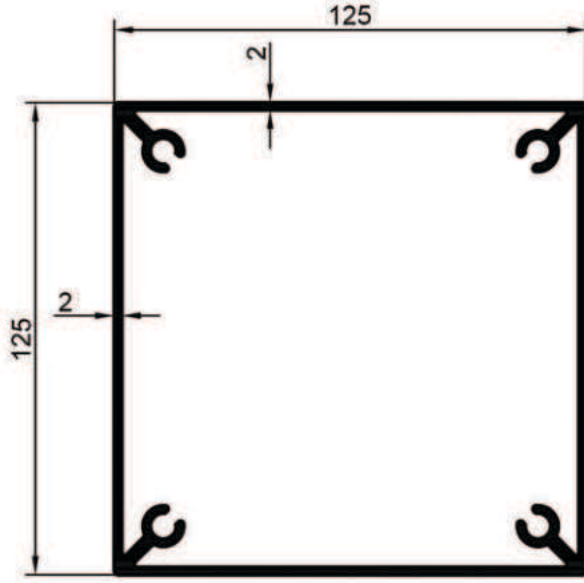

0162

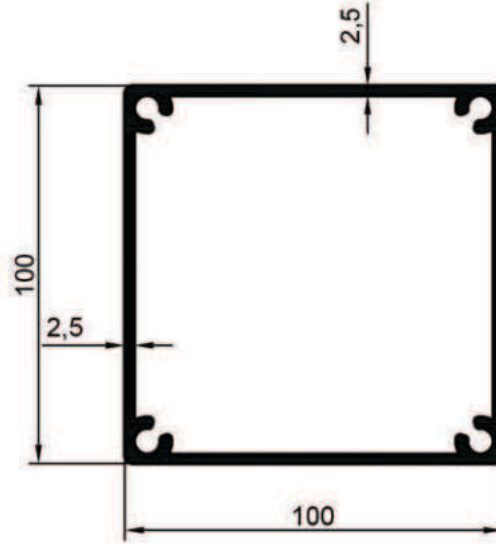

0037

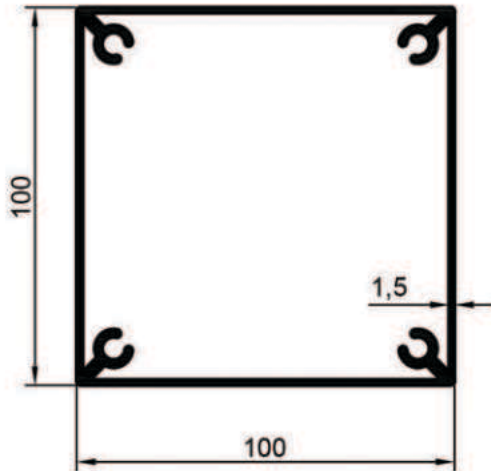

0094

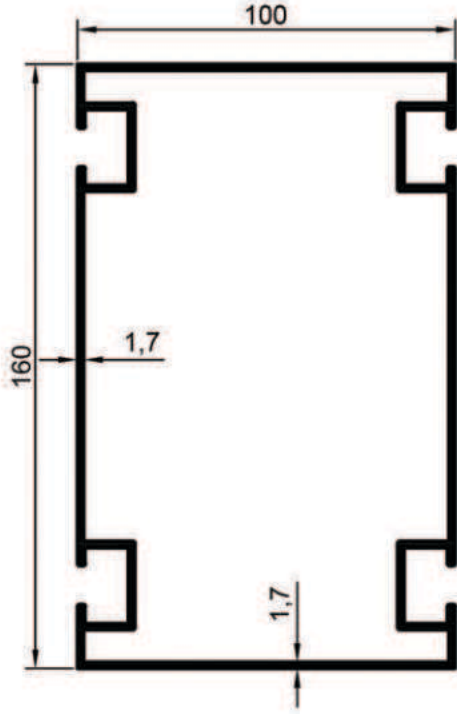

0128

160X100 DİREK

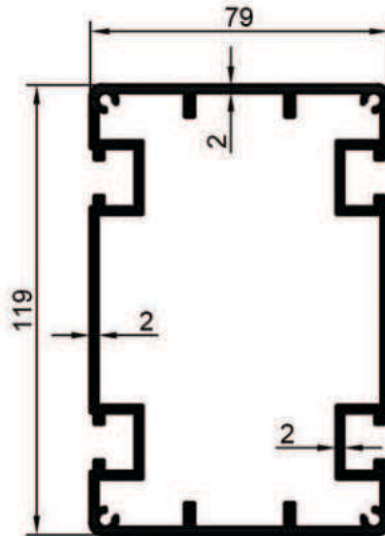

5422

119X79 DİREK

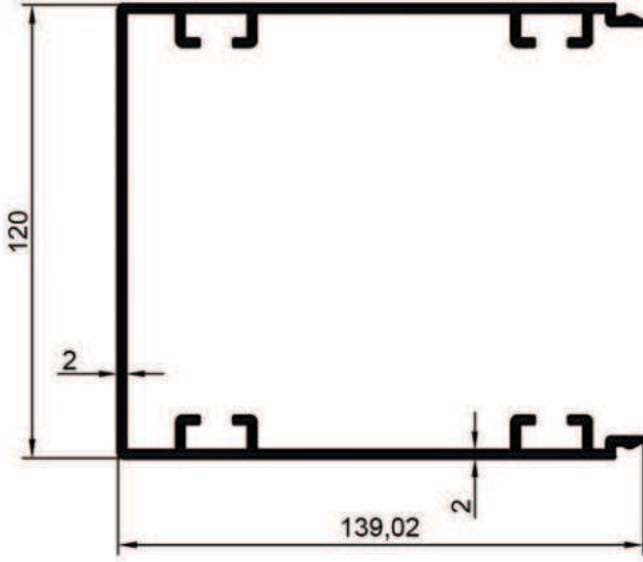

0231

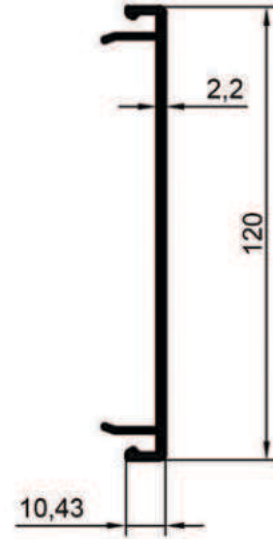

0232

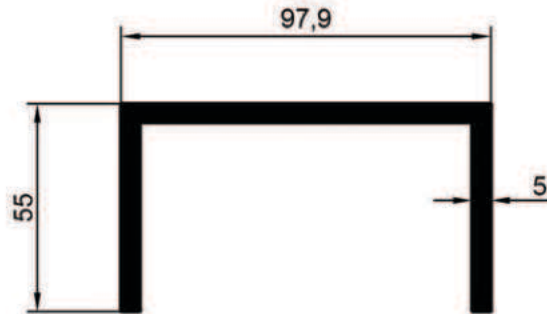

0233

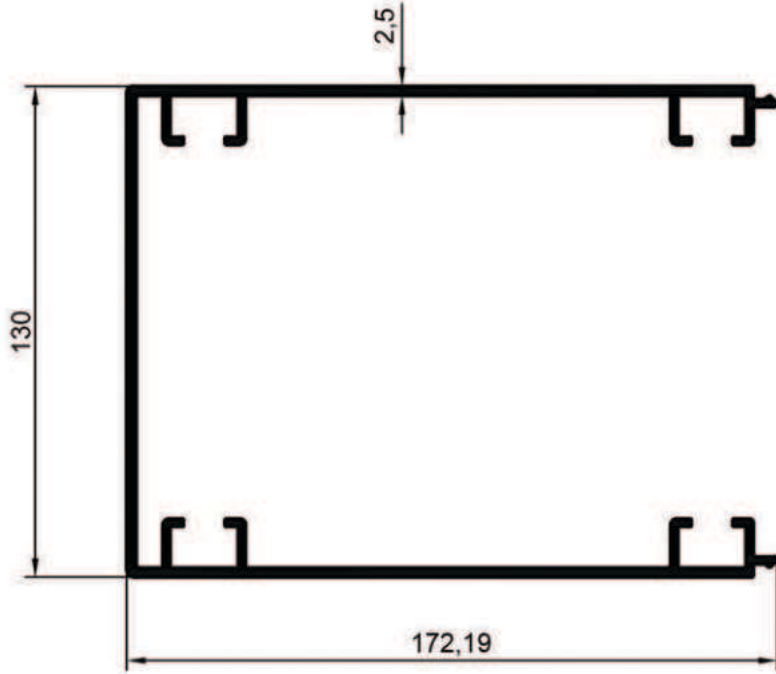

6027



6028

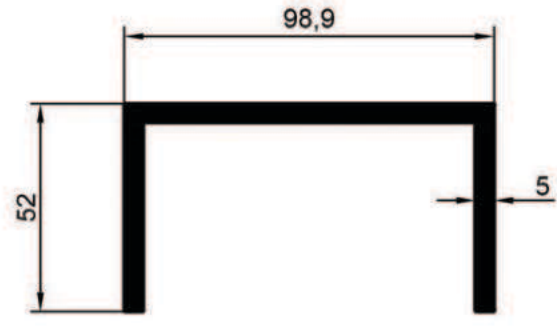

6029

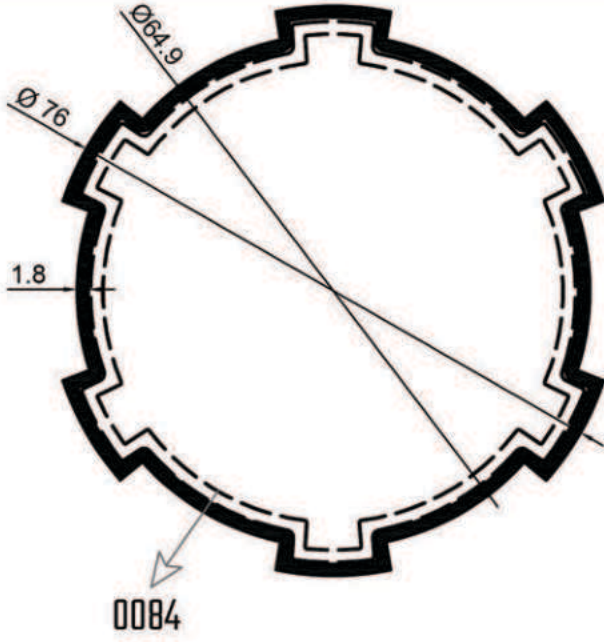

0072

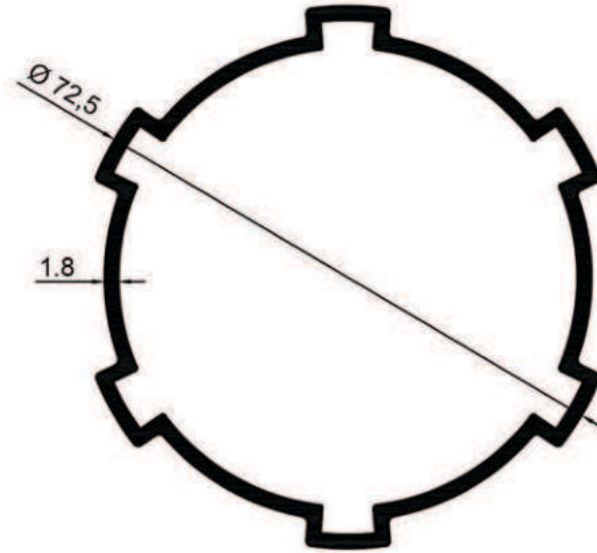

0084

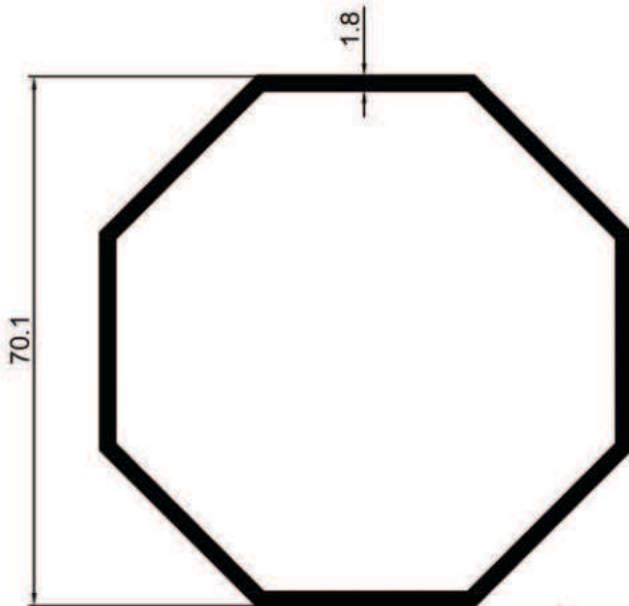

0217

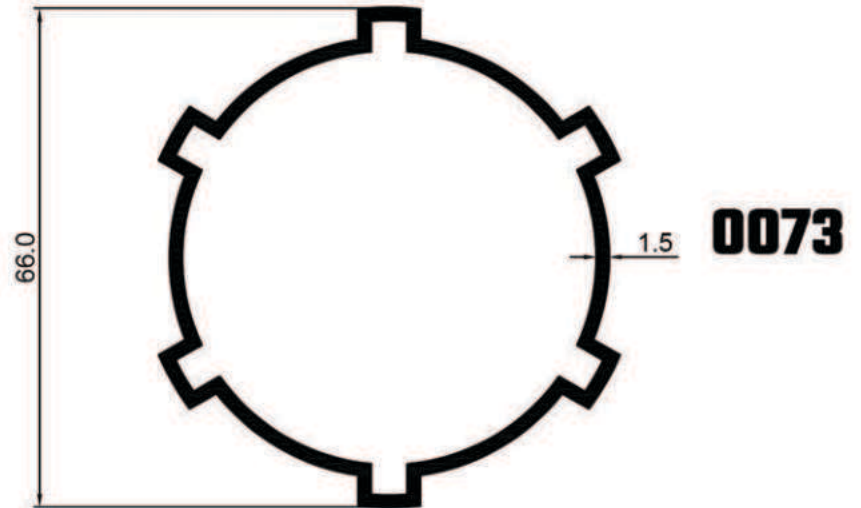
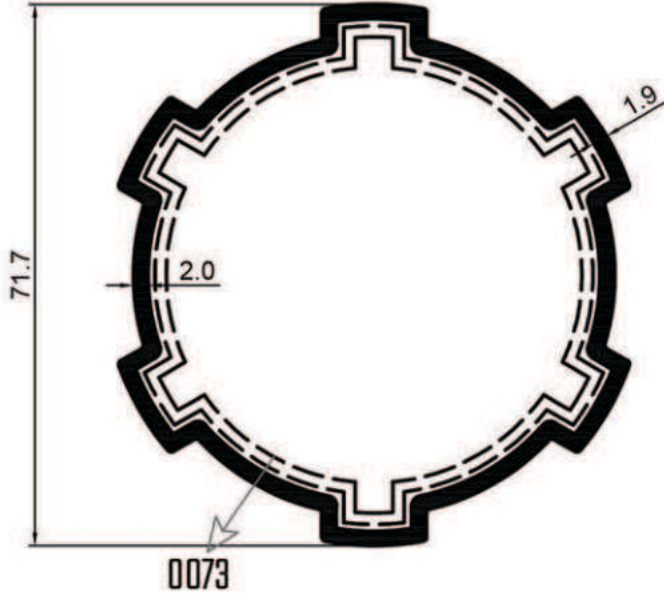

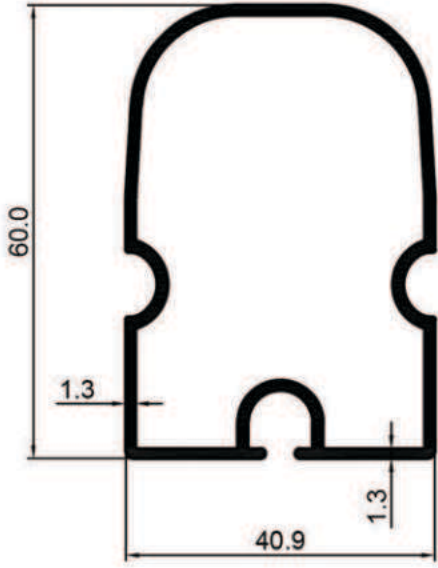

0226

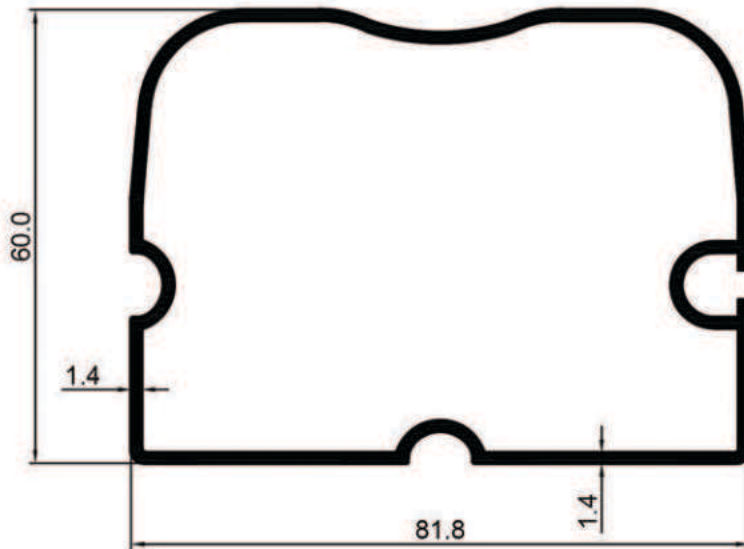

0225

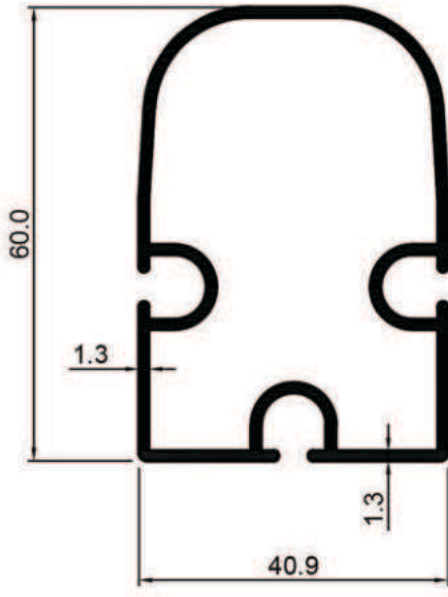

0013

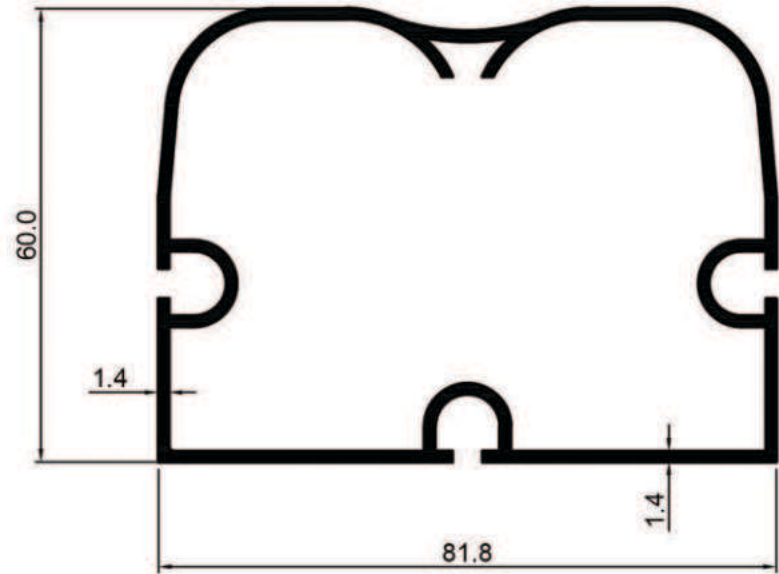

0057

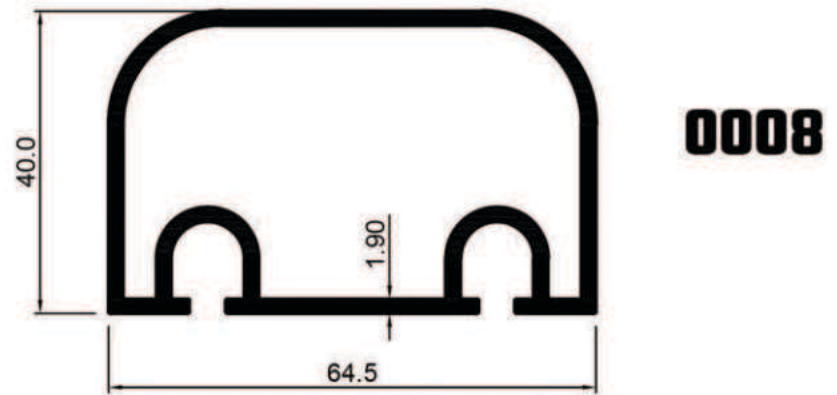
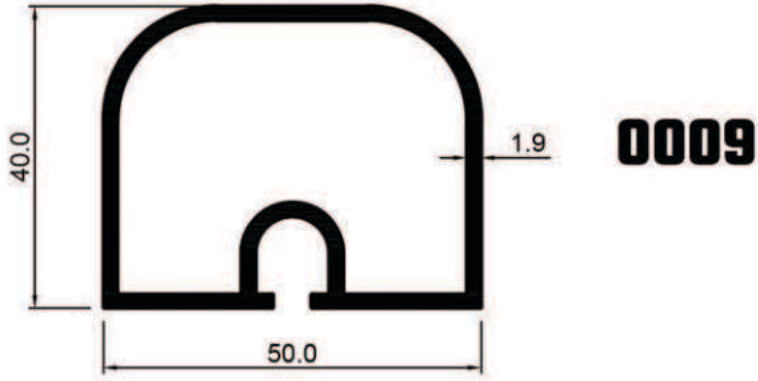

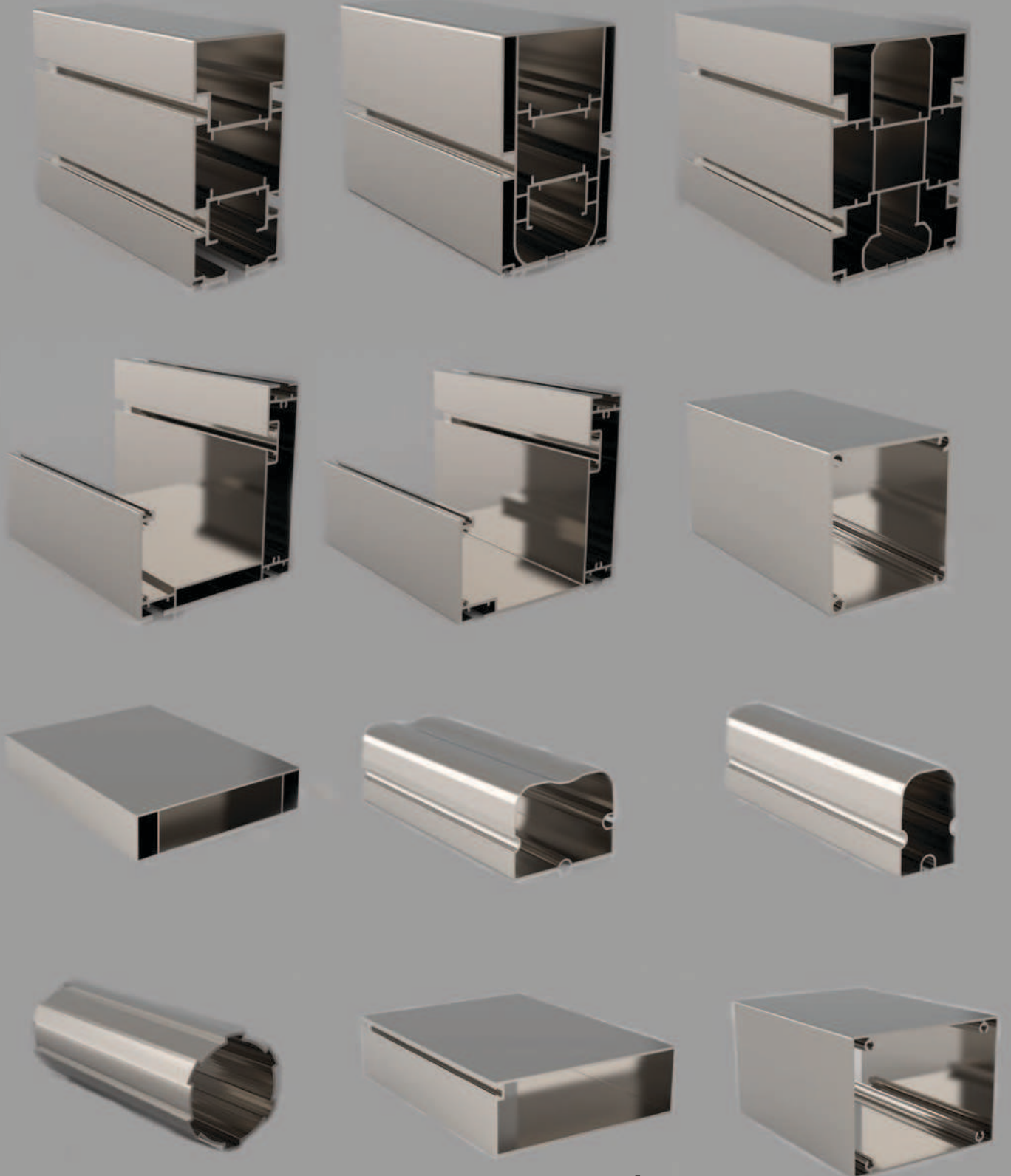

70 LİK PERGOLE GEÇMELİ AKSESUAR SETİ

ÜRÜN KODU: G-70

SET FİYATI: _____

	MALZEME ADI	MİKTAR
	70 LİK RAY KAPALI ARKA BAĞLANTI SACI (GALVANİZ)	1 ADET
	70 LİK RAY DELİKLİ ARKA BAĞLANTI SACI (GALVANİZ)	5 ADET
	RAY DUVAR U BAĞLANTI SACI (GALVANİZ)	3 ADET
	OLUK RAY BAĞLANTISI (GALVANİZ)	6 ADET
	KURTAĞZI (GALVANİZ)	3 ADET
	MOTOR LAMASI 8 MM (GALVANİZ)	1 ADET
	ARA KAYIT BAĞLANTI SACI (GALVANİZ)	4 ADET
	KÜÇÜK OLUK YAN KAPAĞI (GALVANİZ)	2 ADET
	AYAK OLUK BAĞLANTI FLANŞI (GALVANİZ)	3 ADET
	100X100 ALÜMİNYUM DÖKÜM PAPUÇ	3 ADET
	70X150 RAY KAFASI	3 ADET
	KARE MİL	3 ADET
	KÜÇÜK KORNİŞ YAN GEÇME	12 ADET
	KÜÇÜK KORNİŞ ORTA GEÇME	6 ADET
	BÜYÜK KORNİŞ YAN GEÇME	4 ADET
	BÜYÜK KORNİŞ ORTA GEÇME	2 ADET
	ARKA KAFES DİŞLİSİ	3 ADET
	BÜYÜK RULMAN	6 ADET
	ARKA KAFES PLASTİĞİ SAĞ-SOL	3 TAKIM
	FREN	3 ADET

www.regrup.net



ÖN RULMAN TAKIMI

3 TAKIM

KÜÇÜK RULMAN

6 ADET

ÖN GERGİ TAKOZU SAĞ-SOL

3 TAKIM

MOTOR KAPAĞI

1 ADET

KÜÇÜK ARABA

24 ADET

BÜYÜK ARABA

3 ADET

TRİGER BAĞLANTI PLASTİĞİ

3 ADET

TRAFO 24V - 5 AMPER

1 ADET

SLİM LED

25 ADET

90 LIK LAZER SAC AKSESUAR SETİ

SET FİYATI: _____

MALZEME ADI

SET ADETİ

	90 LIK RAY KAPALI ARKA BAĞLANTI SACI SAĞ (GALVANİZ)	1 ADET
	90 LIK RAY DELİKLİ ARKA BAĞLANTI SACI SAĞ (GALVANİZ)	2 ADET
	90 LIK RAY DELİKLİ ARKA BAĞLANTI SACI SOL (GALVANİZ)	3 ADET
	RAY DUVAR U BAĞLANTI SACI (GALVANİZ)	3 ADET
	OLUK RAY BAĞLANTISI (GALVANİZ)	6 ADET
	KURTAĞZI (GALVANİZ)	3 ADET
	MOTOR LAMASI 8 MM (GALVANİZ)	1 ADET
	ARA KAYIT BAĞLANTI SACI (GALVANİZ)	4 ADET
	İNCE OLUK YAN KAPAĞI (GALVANİZ)	2 ADET
	AYAK OLUK BAĞLANTI FLANŞI (GALVANİZ)	3 ADET

90 LIK PERGOLE GEÇMELİ AKSESUAR SETİ

ÜRÜN KODU: G-90











SET FİYATI: _____

	MALZEME ADI	MİKTAR
	90 LIK RAY KAPALI ARKA BAĞLANTI SACI (GALVANİZ)	1 ADET
	90 LIK RAY DELİKLİ ARKA BAĞLANTI SACI SAĞ (GALVANİZ)	2 ADET
	90 LIK RAY DELİKLİ ARKA BAĞLANTI SACI SOL (GALVANİZ)	3 ADET
	RAY DUVAR U BAĞLANTI SACI (GALVANİZ)	3 ADET
	OLUK RAY BAĞLANTISI (GALVANİZ)	6 ADET
	KURTAĞZI (GALVANİZ)	3 ADET
	MOTOR LAMASI 8 MM (GALVANİZ)	1 ADET
	ARA KAYIT BAĞLANTI SACI (GALVANİZ)	4 ADET
	KÜÇÜK OLUK YAN KAPAĞI (GALVANİZ)	2 ADET
	AYAK OLUK BAĞLANTI FLANŞI (GALVANİZ)	3 ADET
	100X100 ALÜMİNYUM DÖKÜM PAPUÇ	3 ADET
	90X150 RAY KAFASI	3 ADET
	KARE MİL	3 ADET
	KÜÇÜK KORNİŞ YAN GEÇME	12 ADET
	KÜÇÜK KORNİŞ ORTA GEÇME	6 ADET
	BÜYÜK KORNİŞ YAN GEÇME	4 ADET
	BÜYÜK KORNİŞ ORTA GEÇME	2 ADET
	ARKA KAFES DİŞLİSİ	3 ADET
	BÜYÜK RULMAN	6 ADET

90 LİK PERGOLE GEÇMELİ AKSESUAR SETİ

ÜRÜN KODU: G-90

SET FİYATI: _____

	MALZEME ADI	MİKTAR
	ARKA KAFES PLASTİĞİ SAĞ-SOL	3 TAKIM
	FREN	3 ADET
	ÖN RULMAN TAKIMI	3 TAKIM
	KÜÇÜK RULMAN	6 ADET
	ÖN GERGİ TAKOZU SAĞ-SOL	3 TAKIM
	MOTOR KAPAĞI	1 ADET
	KÜÇÜK ARABA	24 ADET
	BÜYÜK ARABA	3 ADET
	TRİGER BAĞLANTI PLASTİĞİ	3 ADET
	TRAFO 24V - 5 AMPER	1 ADET
	SLİM LED	25 ADET

110 LUK LAZER SAC AKSESUAR SETİ

SET FİYATI: _____

	MALZEME ADI	SET ADETİ
	110 LUK RAY KAPALI ARKA BAĞLANTI SACI (GALVANİZ)	1 ADET
	110 LUK RAY KAPALI ARKA BAĞLANTI SACI SAĞ (GALVANİZ)	2 ADET
	110 LUK RAY KAPALI ARKA BAĞLANTI SACI SOL (GALVANİZ)	3 ADET
	RAY DUVAR U BAĞLANTI SACI (GALVANİZ)	3 ADET
	OLUK RAY BAĞLANTISI (GALVANİZ)	6 ADET
	KURTAĞZI (GALVANİZ)	3 ADET
	MOTOR LAMASI 8 MM (GALVANİZ)	1 ADET
	ARA KAYIT BAĞLANTI SACI (GALVANİZ)	4 ADET
	İNCE OLUK YAN KAPAĞI (GALVANİZ)	2 ADET
	AYAK OLUK BAĞLANTI FLANŞI (GALVANİZ)	3 ADET

110 LUK PERGOLE GEÇMELİ AKSESUAR SETİ

ÜRÜN KODU: G-110

SET FİYATI: _____

	MALZEME ADI	MİKTAR
	110 LUK RAY KAPALI ARKA BAĞLANTI SACI (GALVANİZ)	1 ADET
	110 LUK RAY KAPALI ARKA BAĞLANTI SACI SAĞ (GALVANİZ)	2 ADET
	110 LUK RAY KAPALI ARKA BAĞLANTI SACI SOL (GALVANİZ)	3 ADET
	RAY DUVAR U BAĞLANTI SACI (GALVANİZ)	3 ADET
	OLUK RAY BAĞLANTISI (GALVANİZ)	6 ADET
	KURTAĞZI (GALVANİZ)	3 ADET
	MOTOR LAMASI 8 MM (GALVANİZ)	1 ADET
	ARA KAYIT BAĞLANTI SACI (GALVANİZ)	4 ADET
	KÜÇÜK OLUK YAN KAPAĞI (GALVANİZ)	2 ADET
	AYAK OLUK BAĞLANTI FLANŞI (GALVANİZ)	3 ADET
	100X100 ALÜMİNYUM DÖKÜM PAPUÇ	3 ADET
	110X150 RAY KAFASI	3 ADET
	KARE MİL	3 ADET
	KÜÇÜK KORNİŞ YAN GEÇME	12 ADET
	KÜÇÜK KORNİŞ ORTA GEÇME	6 ADET
	BÜYÜK KORNİŞ YAN GEÇME	4 ADET
	BÜYÜK KORNİŞ ORTA GEÇME	2 ADET
	ARKA KAFES DİŞLİSİ	3 ADET
	BÜYÜK RULMAN	6 ADET

110 LUK PERGOLE GEÇMELİ AKSESUAR SETİ

ÜRÜN KODU: G-110

SET FİYATI: _____

	MALZEME ADI	MİKTAR
	ARKA KAFES PLASTİĞİ SAĞ-SOL	3 TAKIM
	FREN	3 ADET
	ÖN RULMAN TAKIMI	3 TAKIM
	KÜÇÜK RULMAN	6 ADET
	ÖN GERGİ TAKOZU SAĞ-SOL	3 TAKIM
	MOTOR KAPAĞI	1 ADET
	KÜÇÜK ARABA	24 ADET
	BÜYÜK ARABA	3 ADET
	TRİGER BAĞLANTI PLASTİĞİ	3 ADET
	TRAFO 24V - 5 AMPER	1 ADET
	SLİM LED	25 ADET



2.GRUP

PERGOLA PROFILE SYSTEMS

www.regrup.net

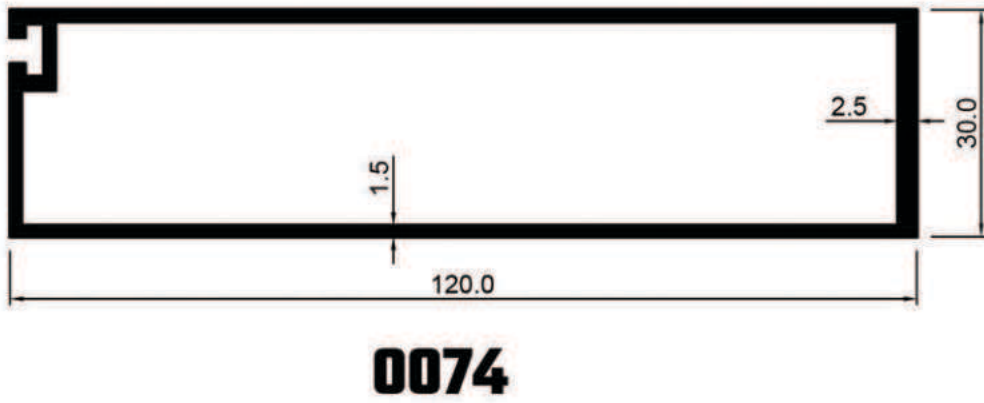
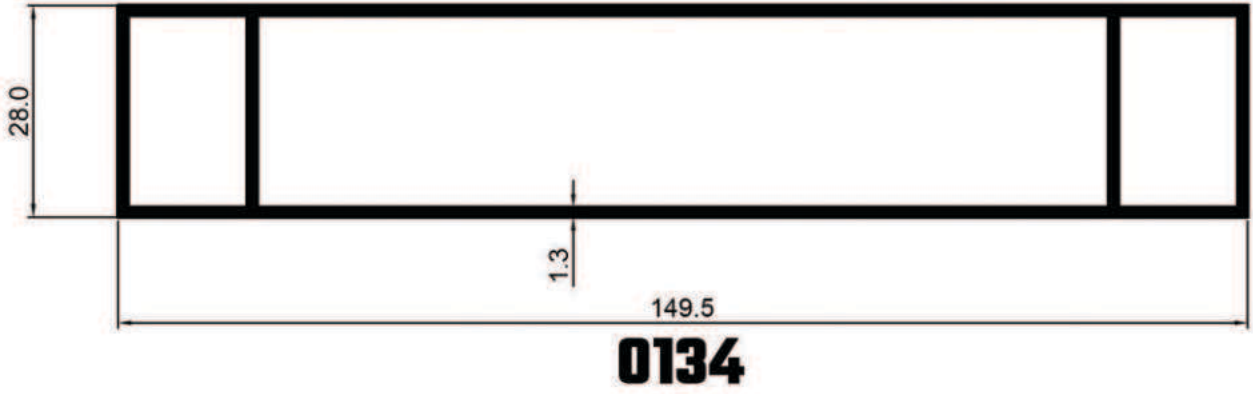
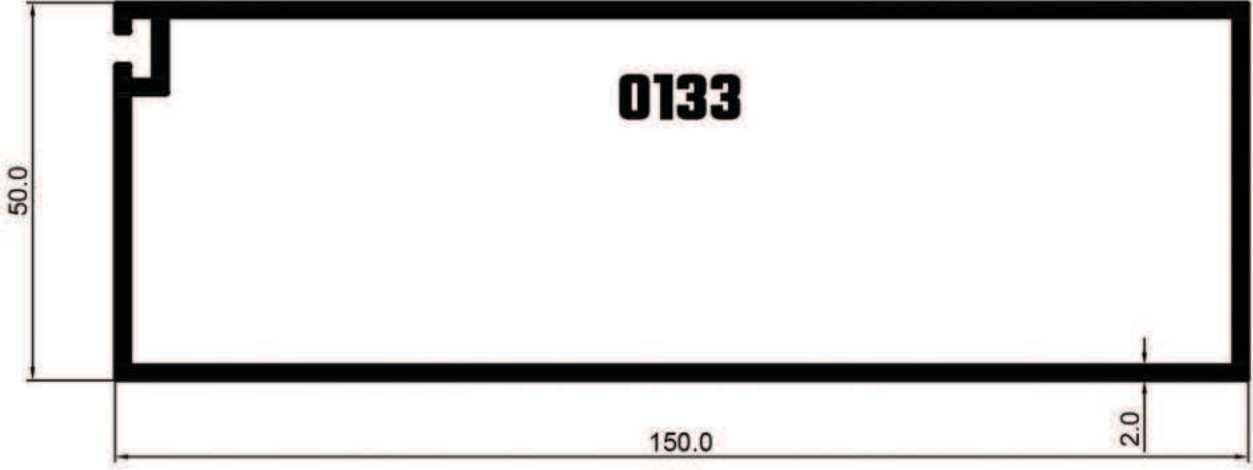

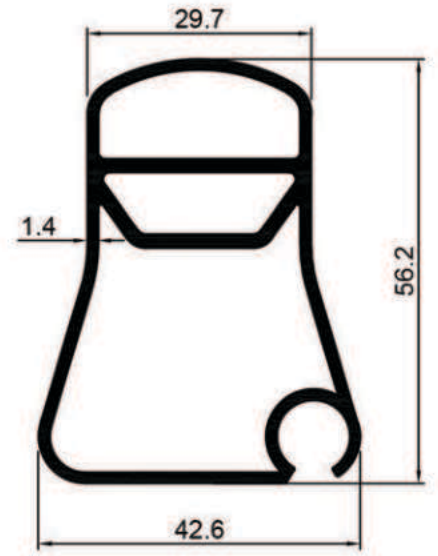
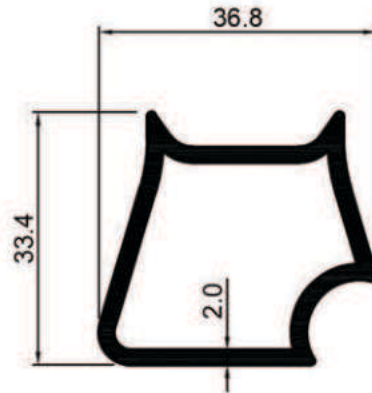
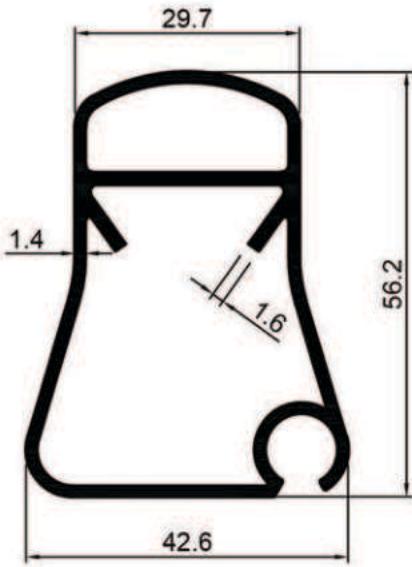
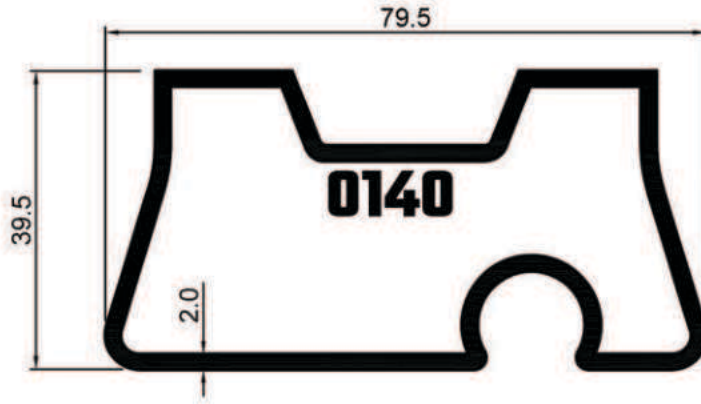
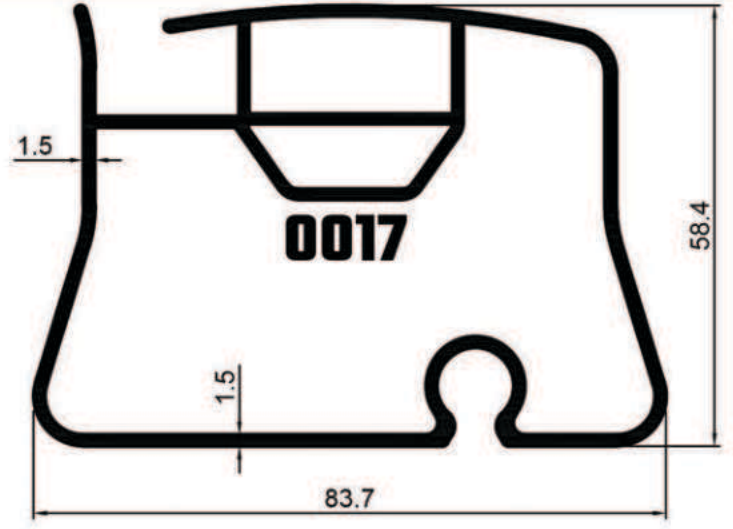
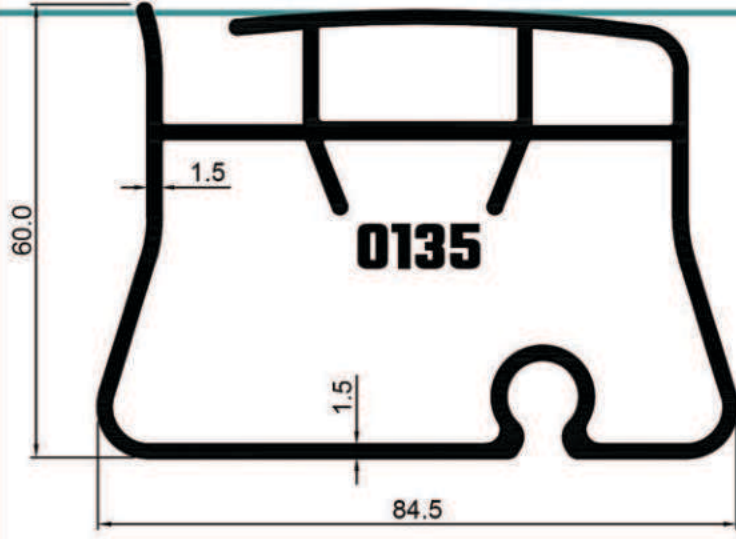

0136

0139

0016

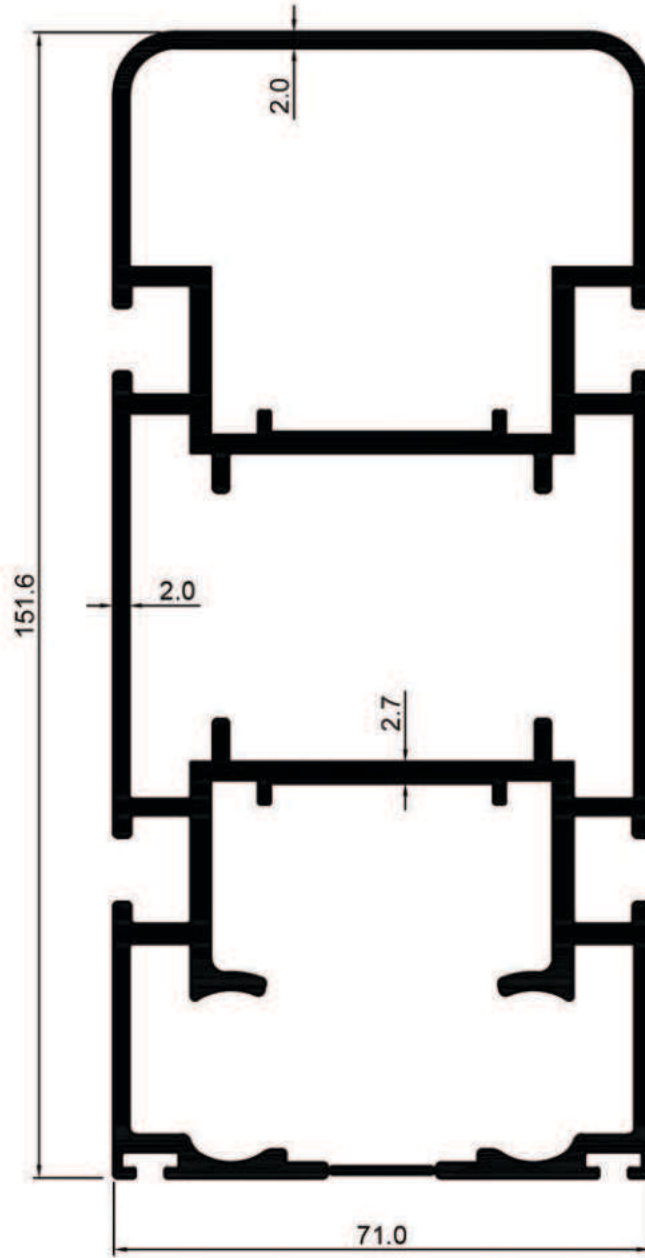

0131
4,283

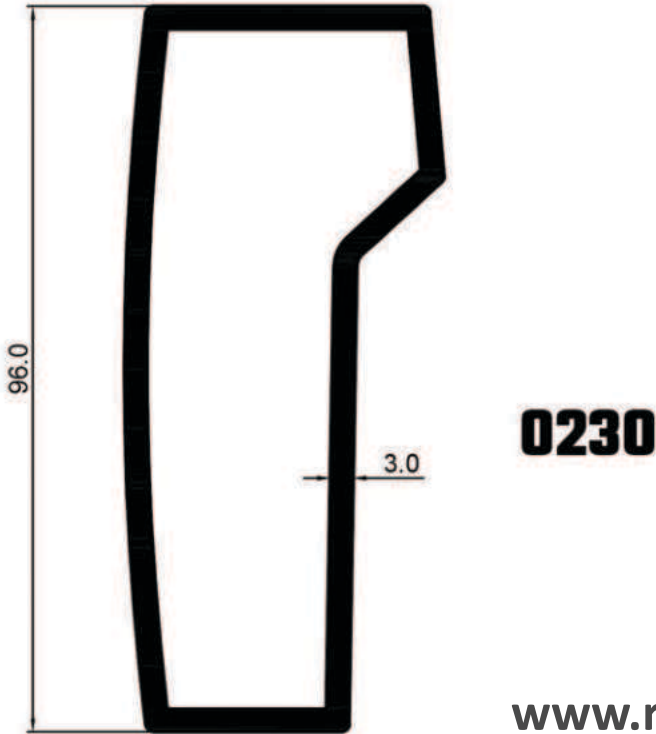
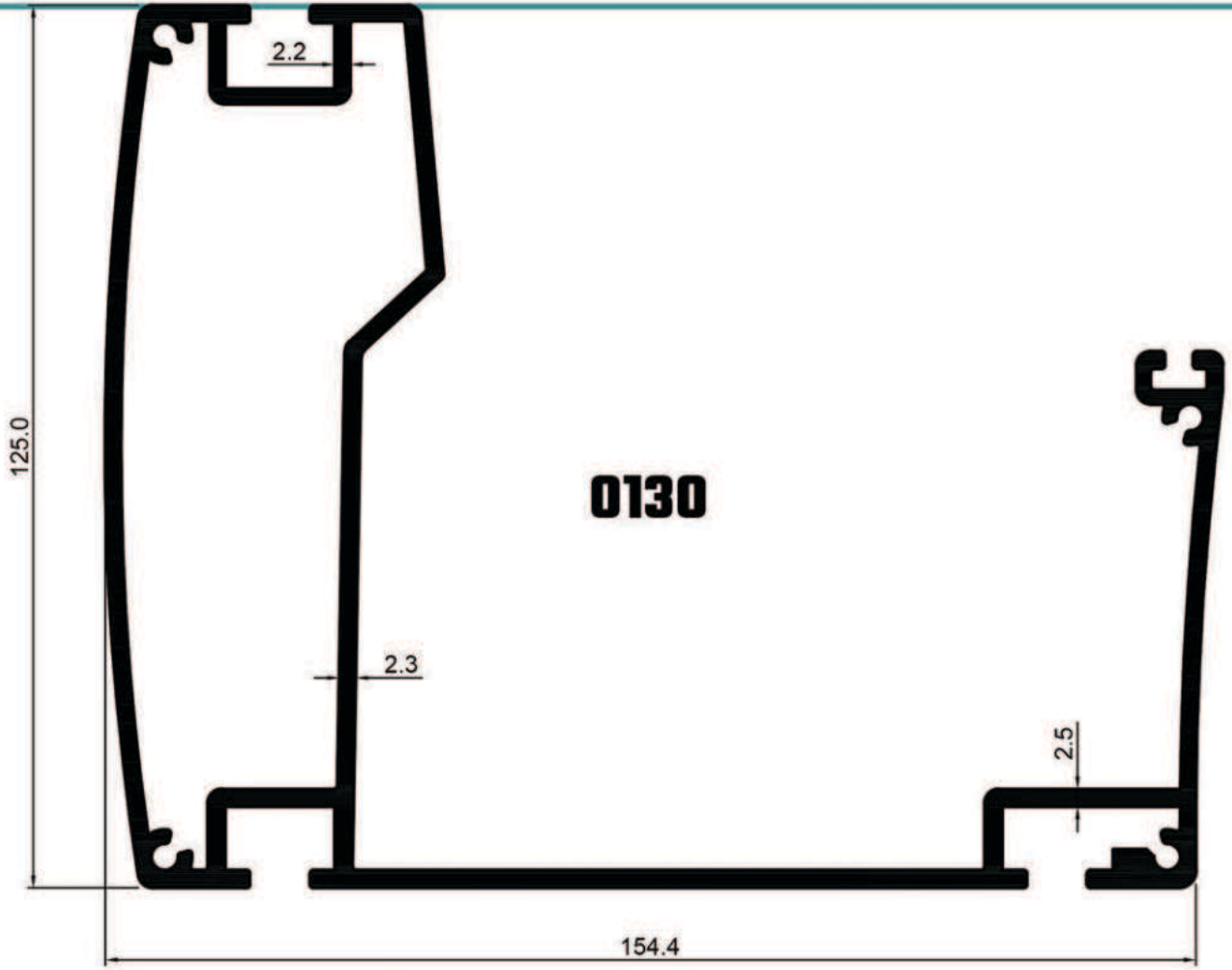



TENTE PROFİL SİSTEMLERİ

AWNING PROFILE SYSTEMS

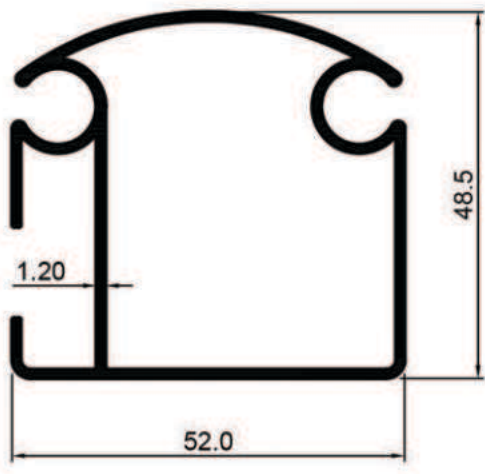

0005

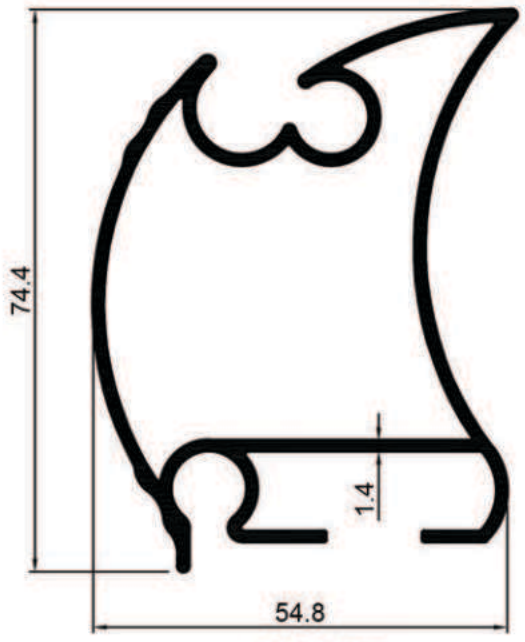

0105

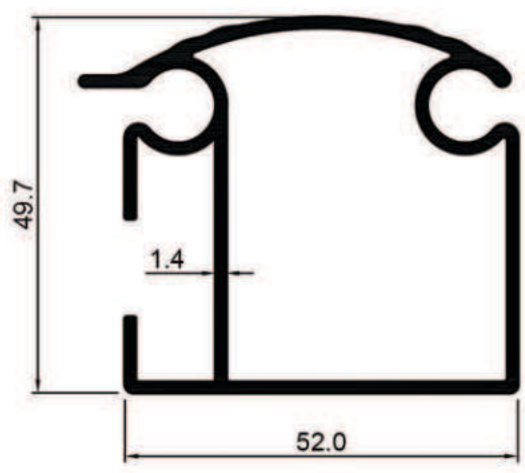

0040

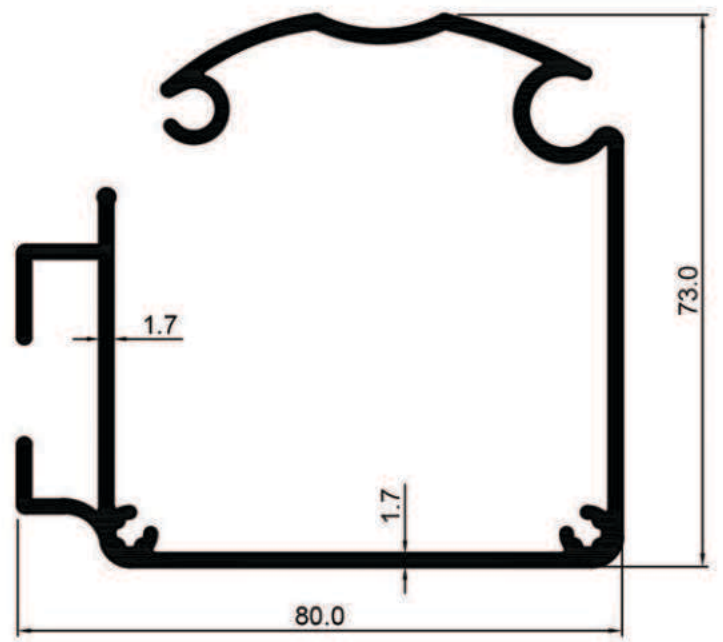

0070

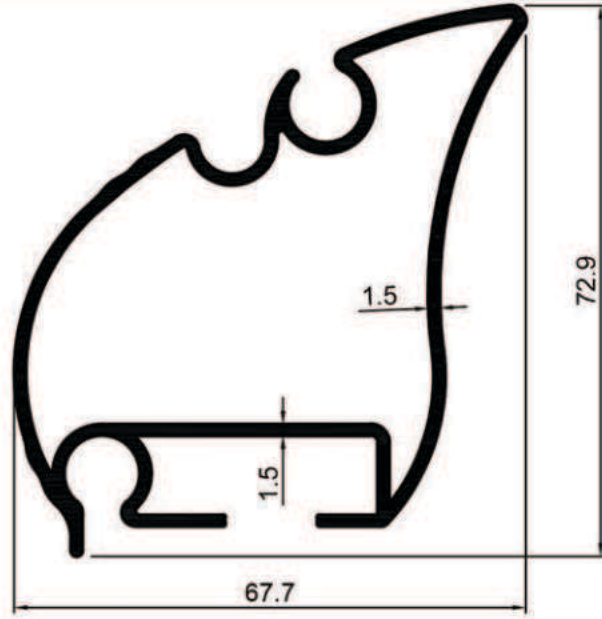

0041

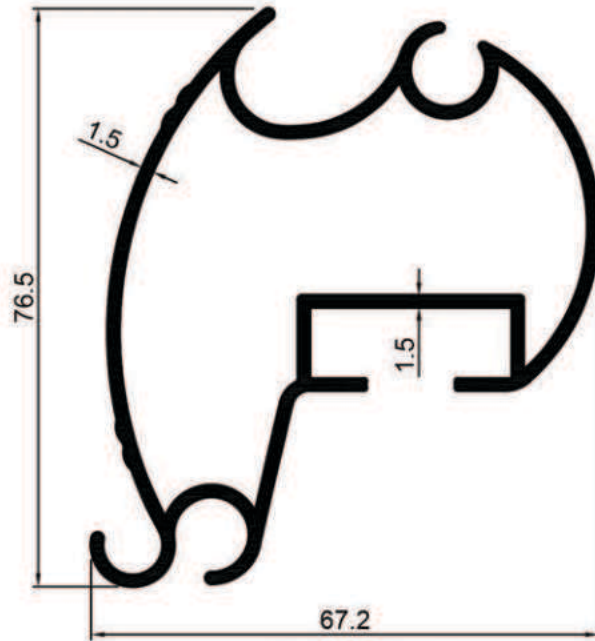

0091

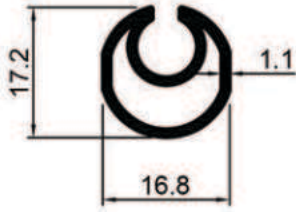

0006

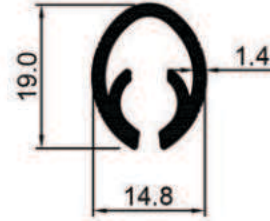

0262

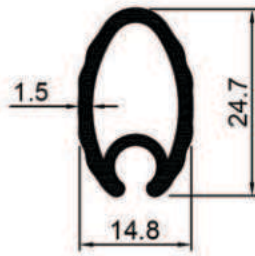

0042

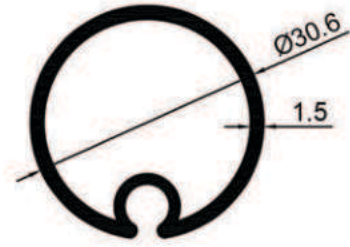

0071

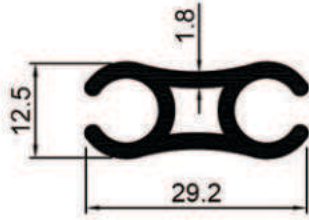

0059

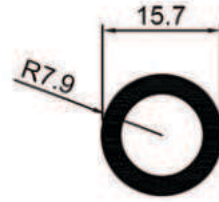

0038



0097



0098

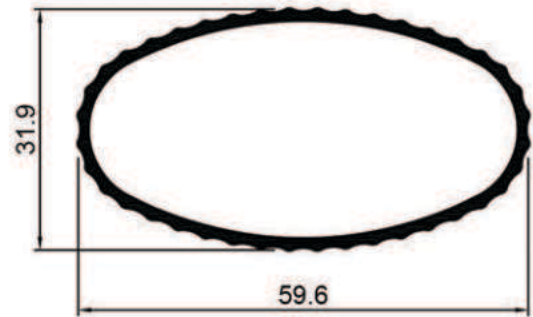
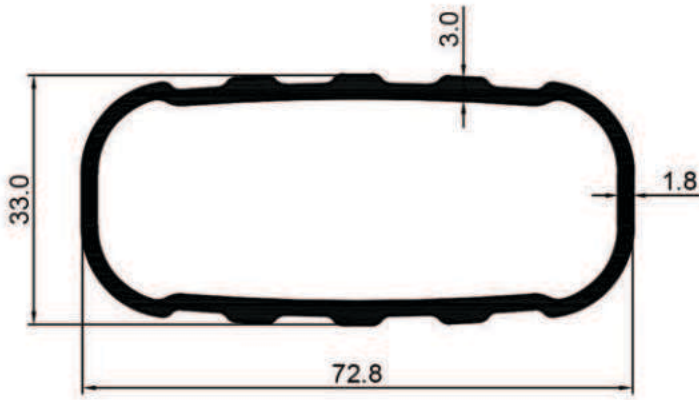
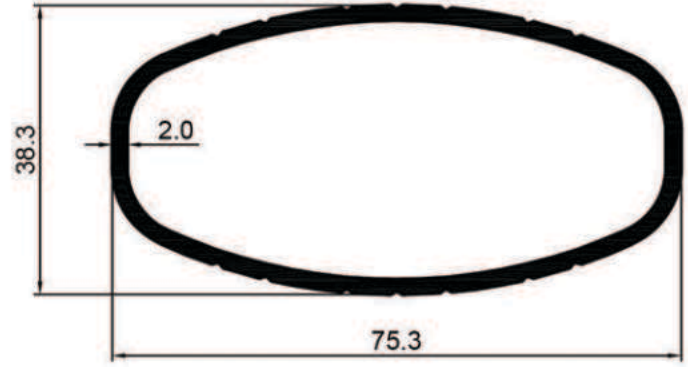
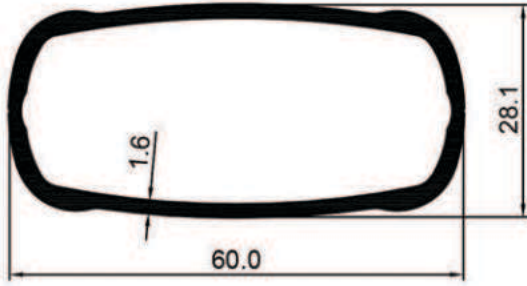

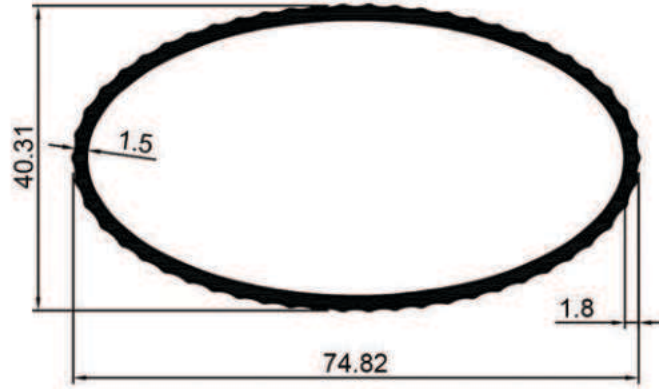

0048

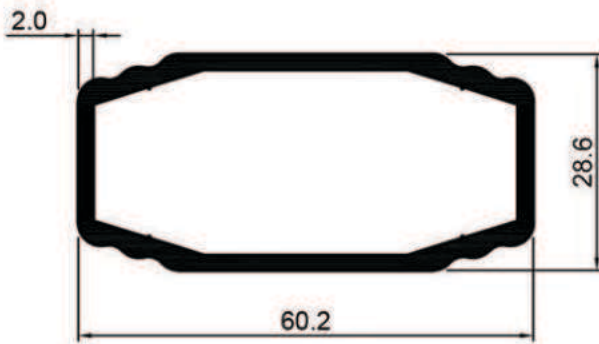

0060

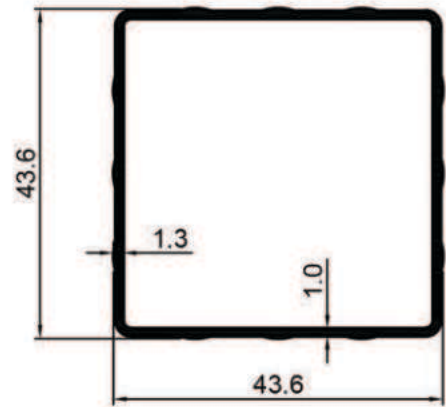

0039

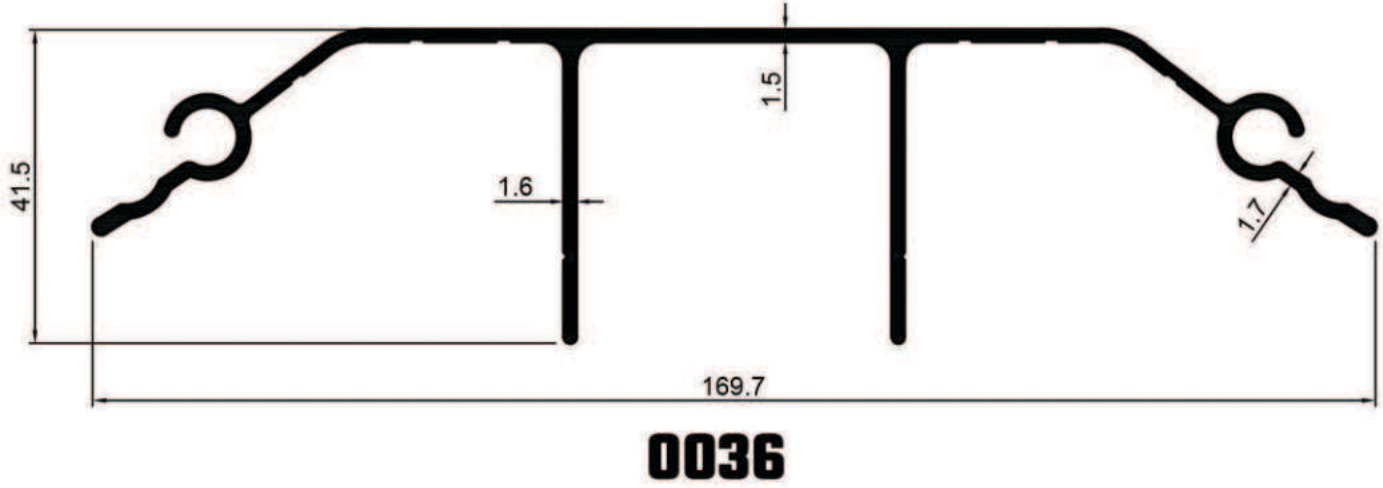

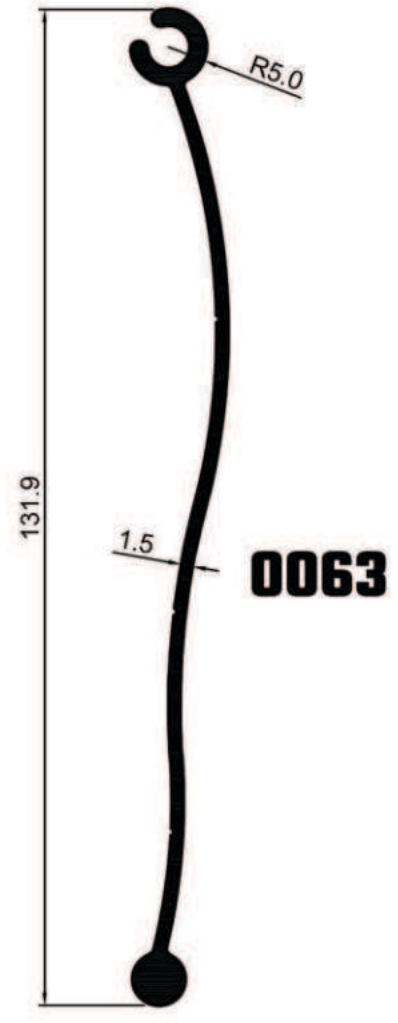
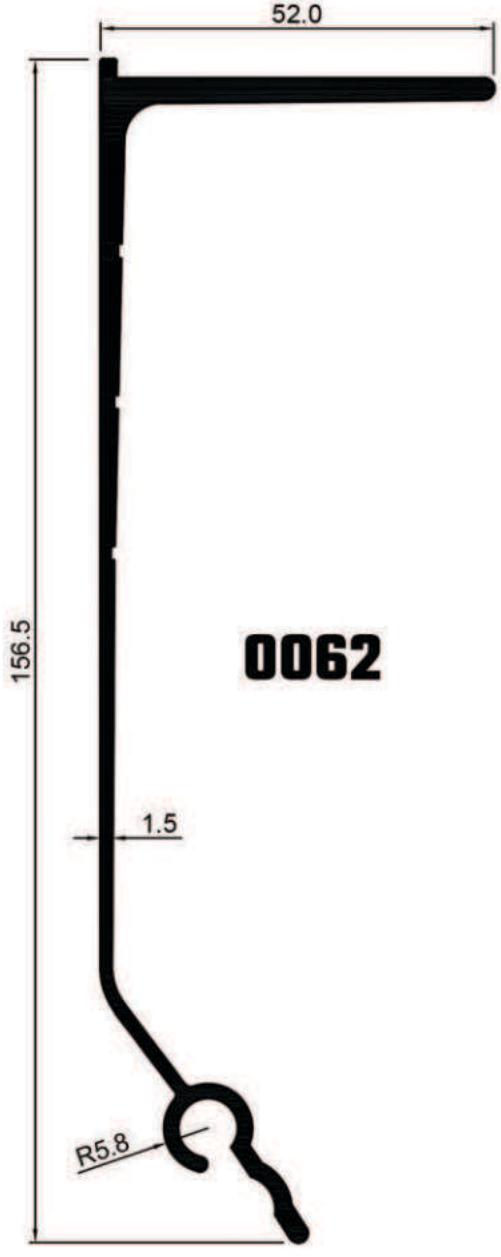

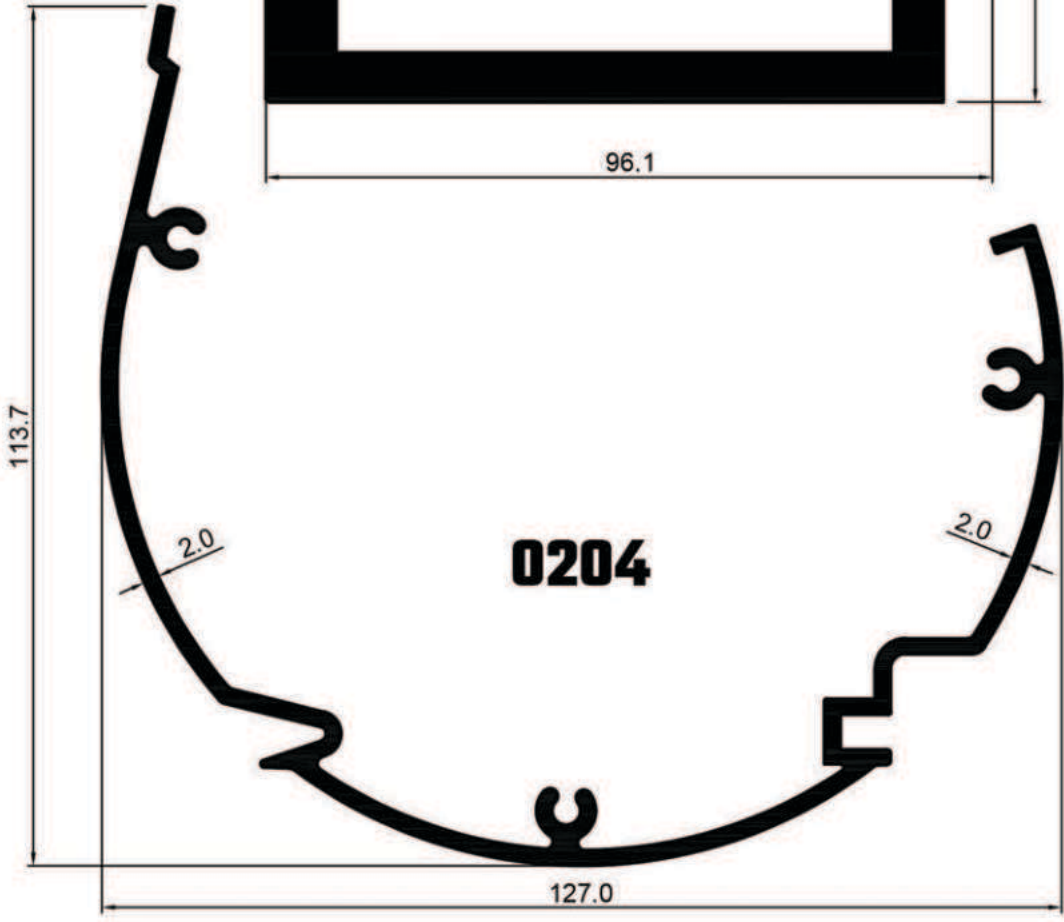
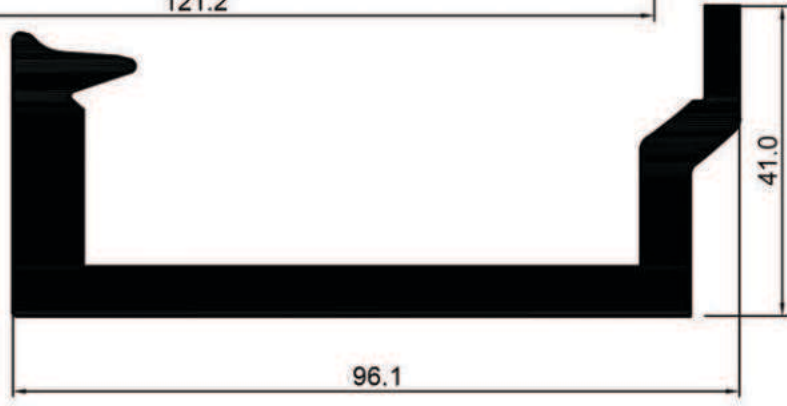
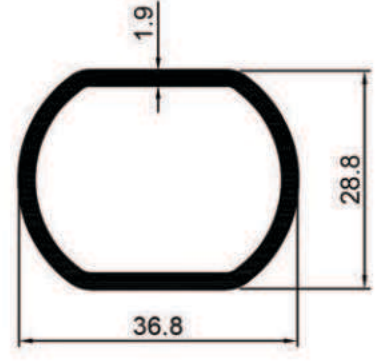
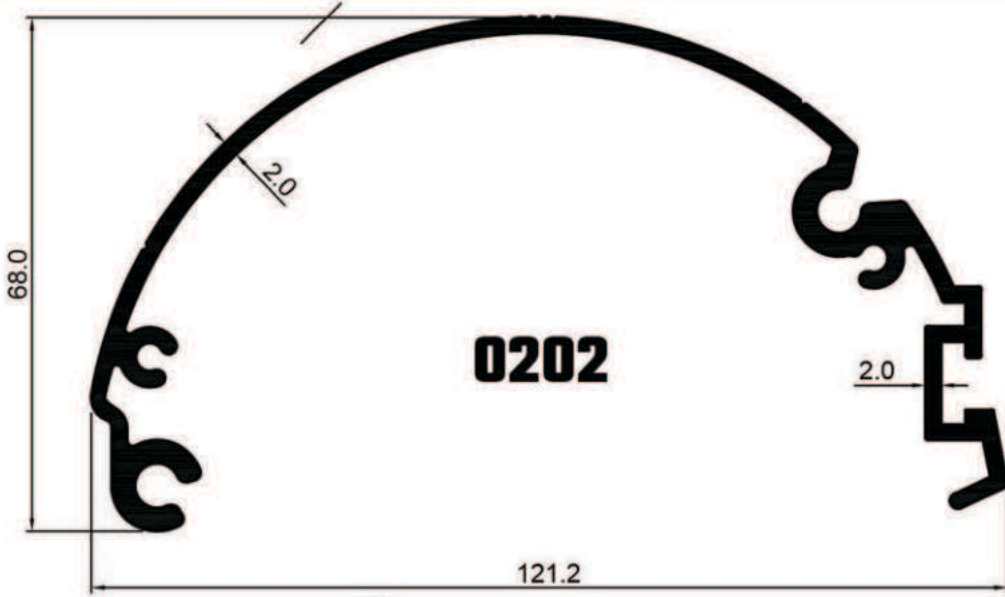

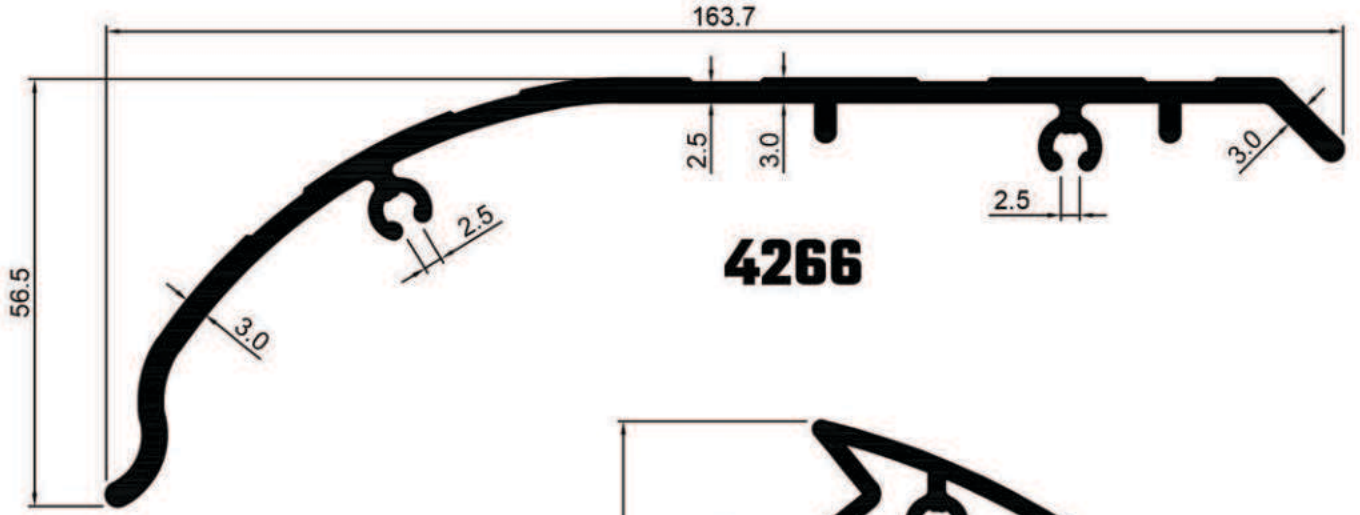

4266

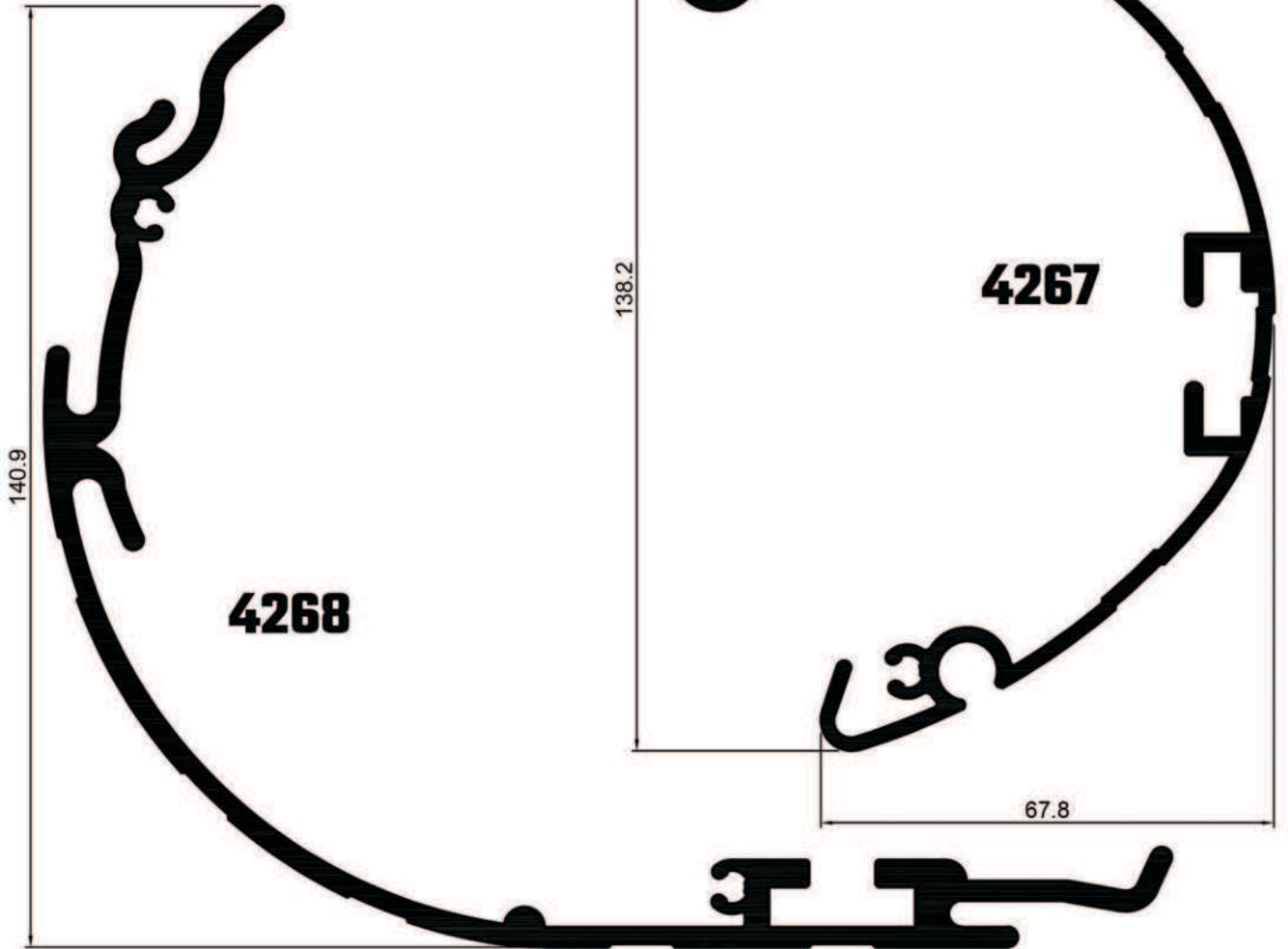

4267

4268

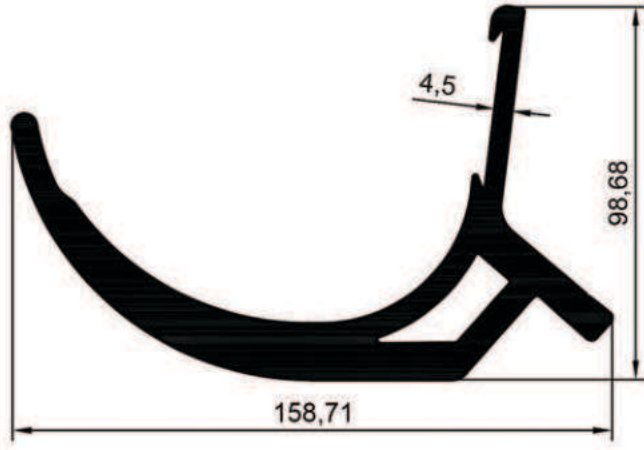

4461



4371

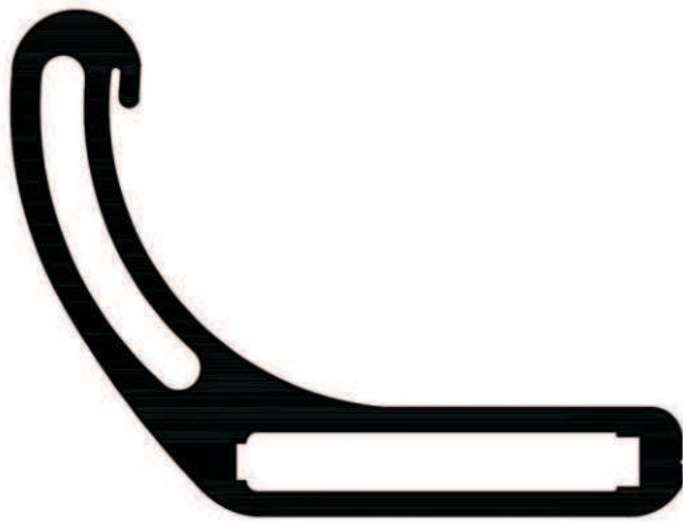

4372

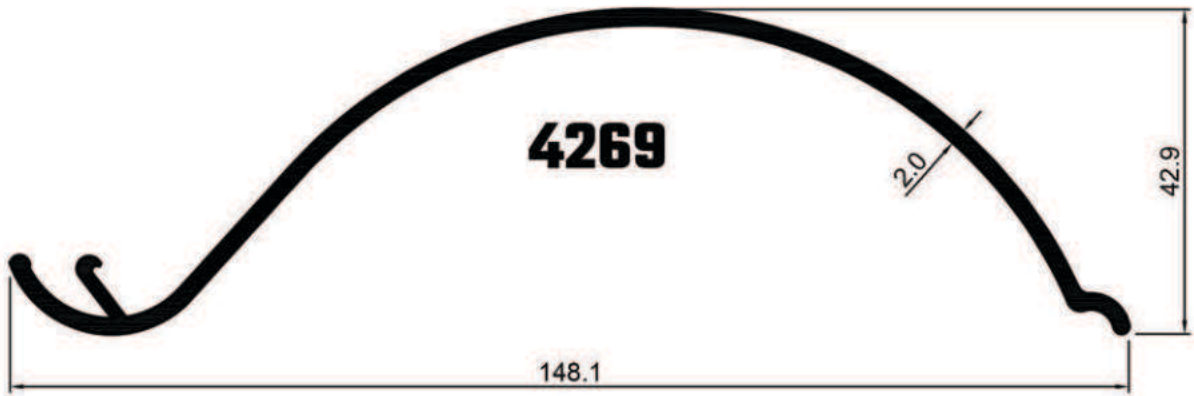



KIŞ BAHÇESİ PROFİLLERİ

WINTER GARDEN PROFILES

www.regrup.net

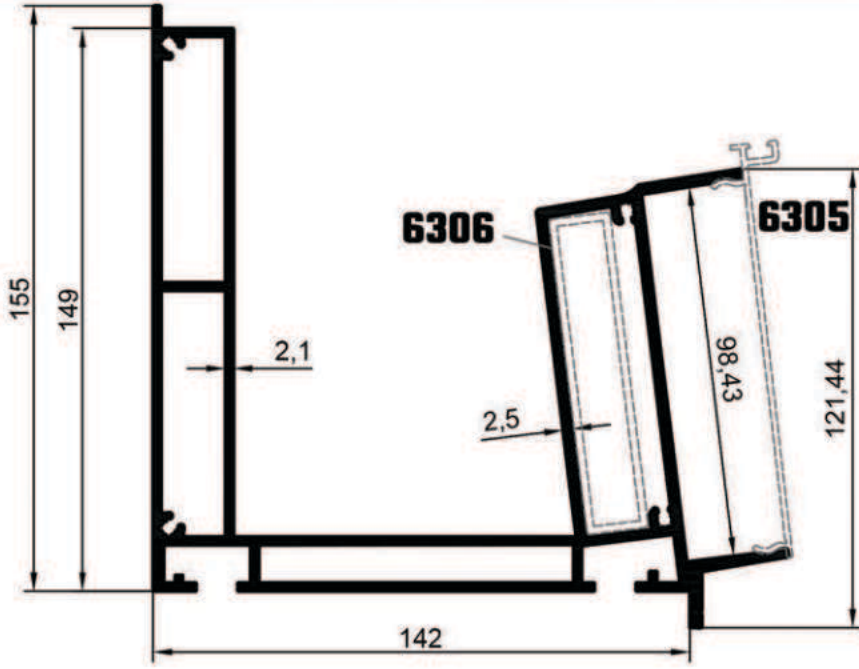

6300

6301

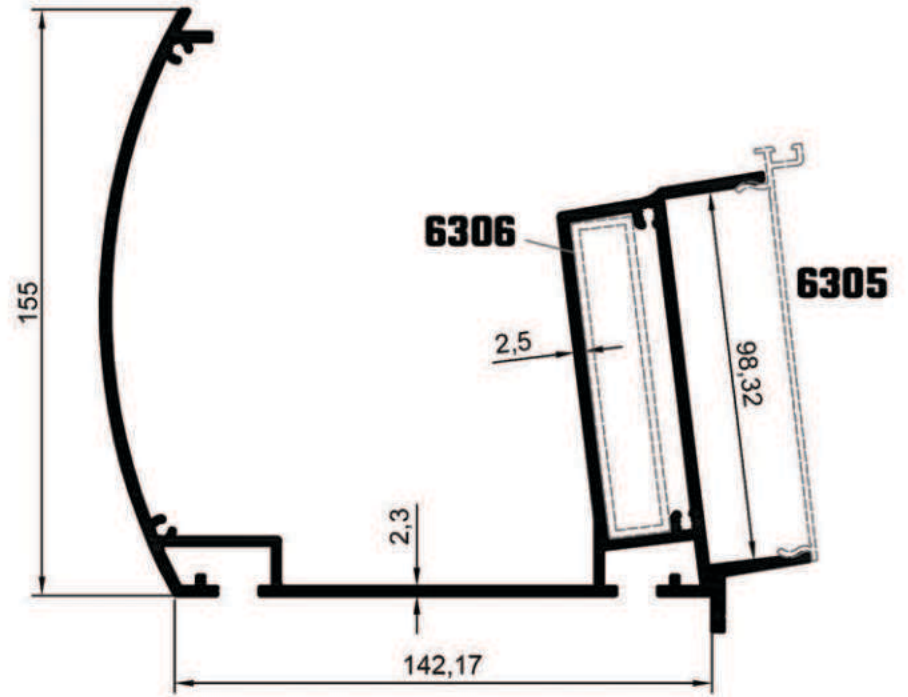

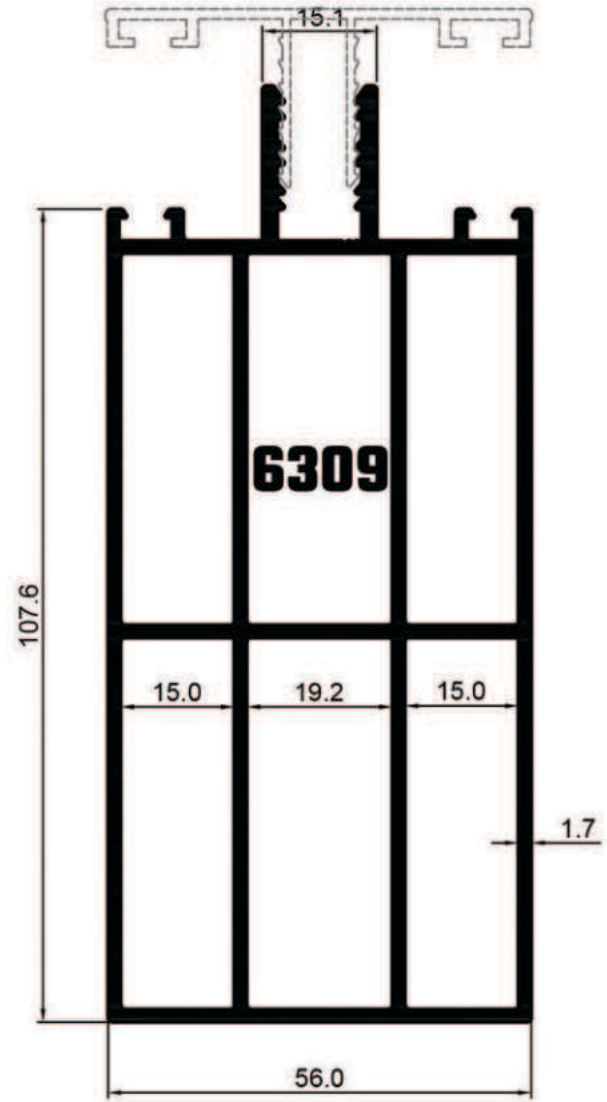
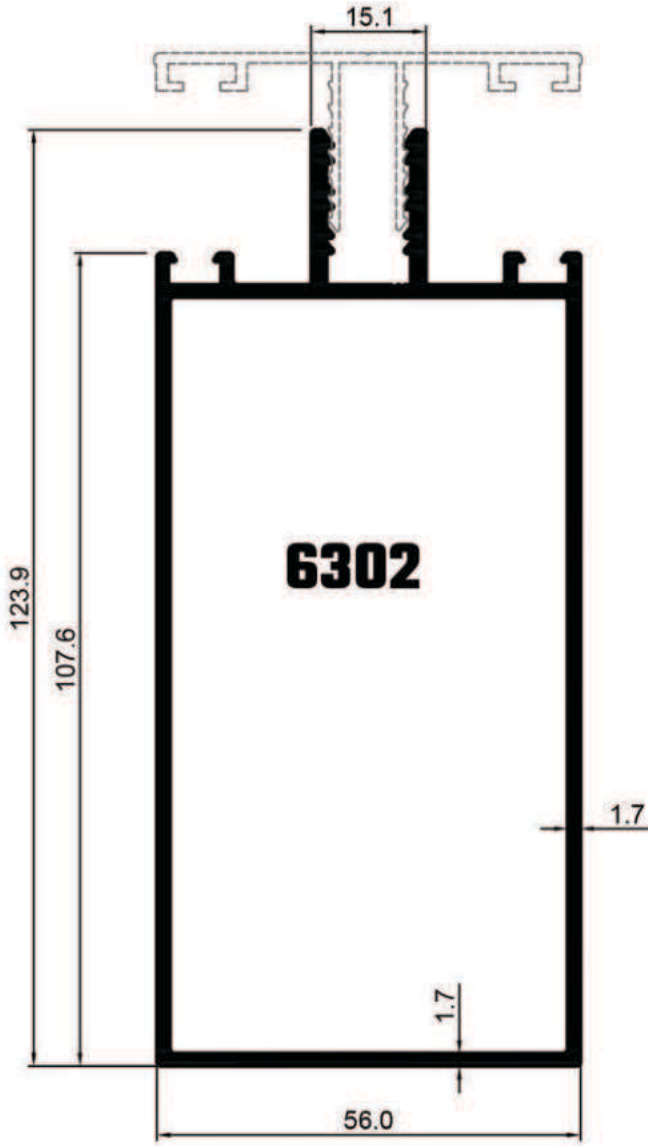
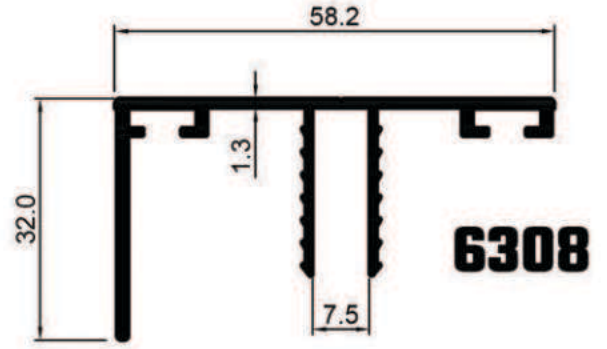
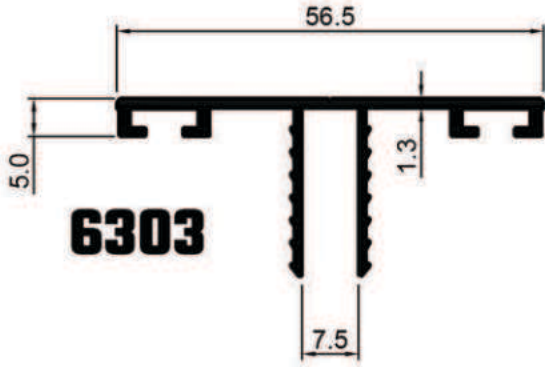

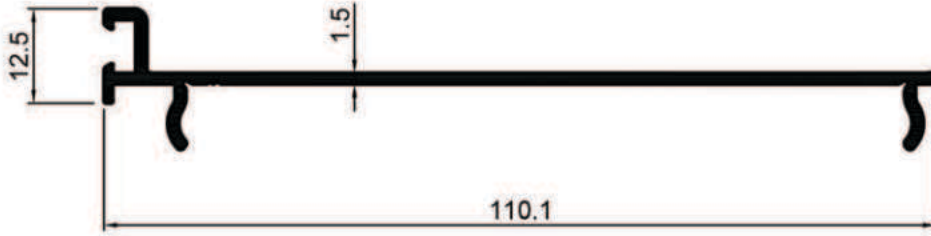

6305

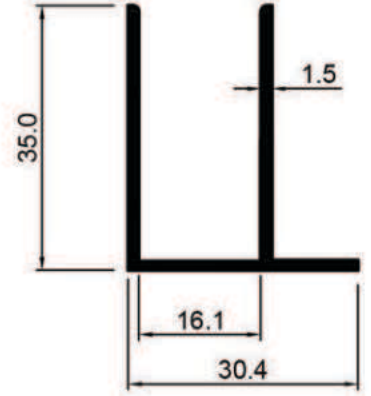

6307

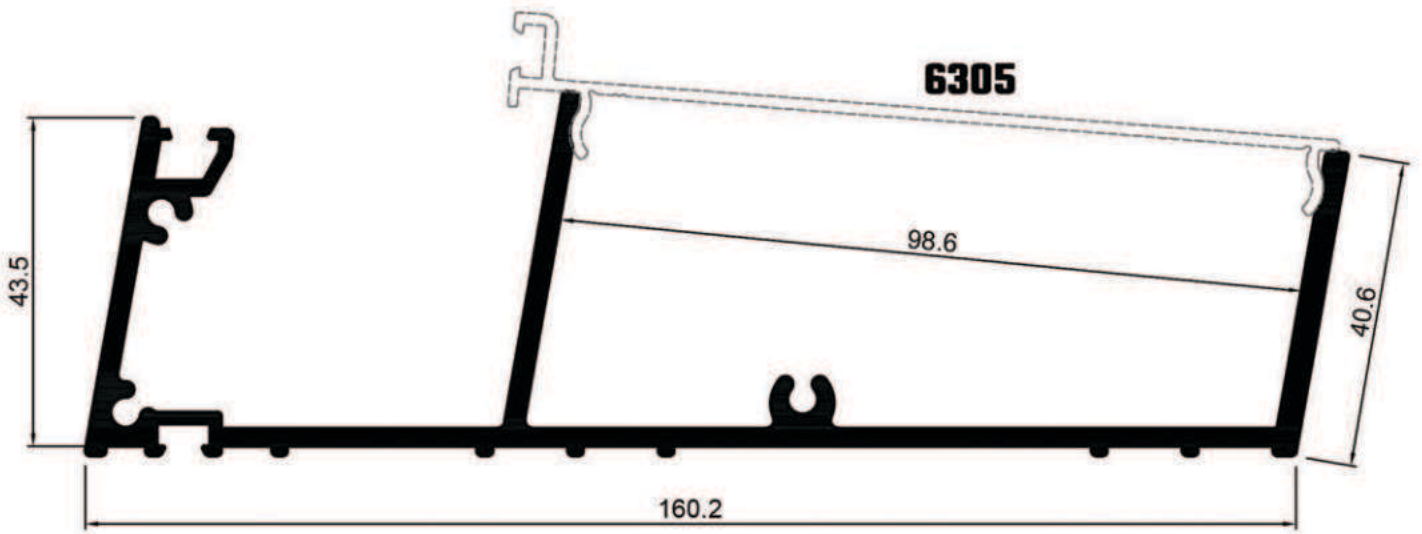

6304

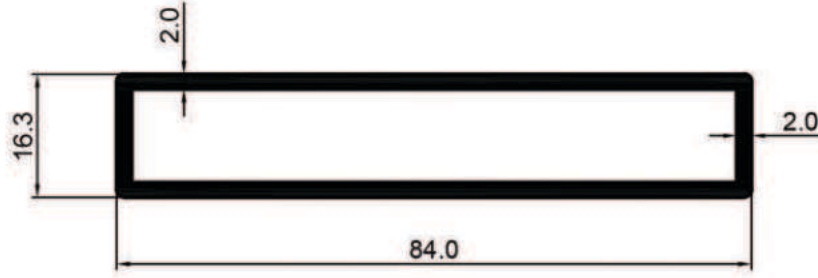

6306

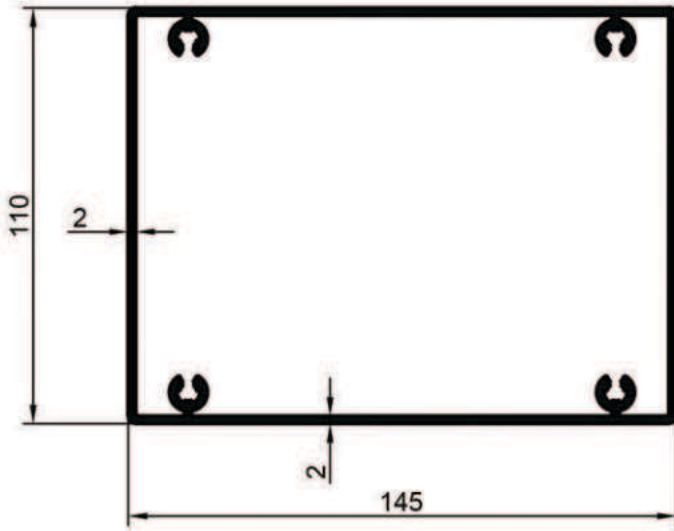

0037

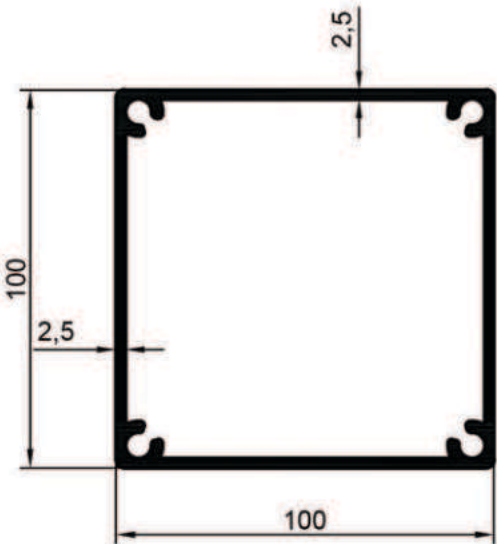

0215

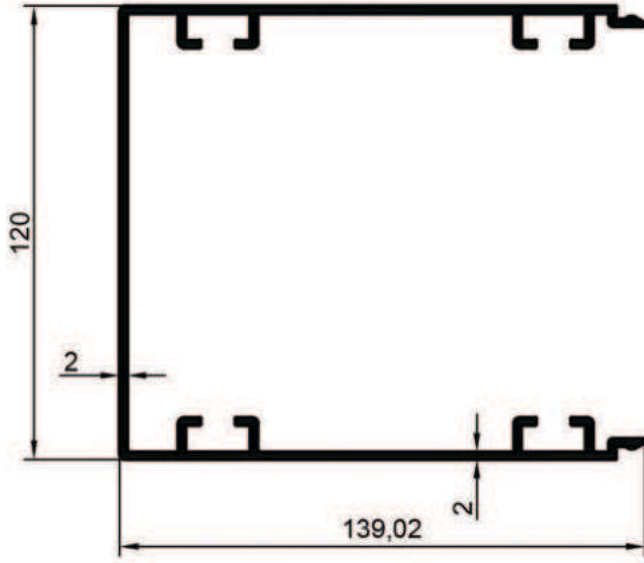

0231

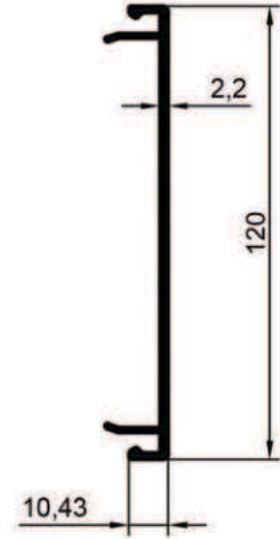

0232

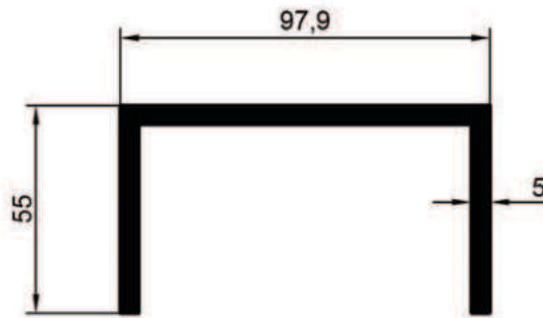

0233

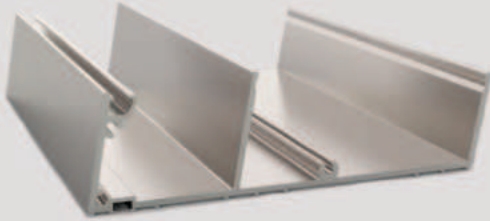
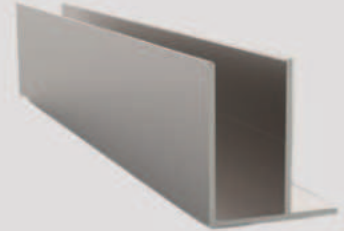
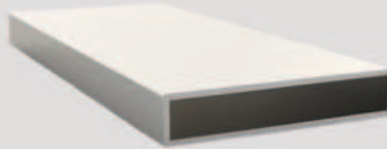
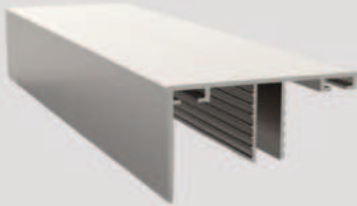
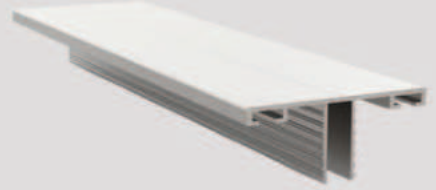
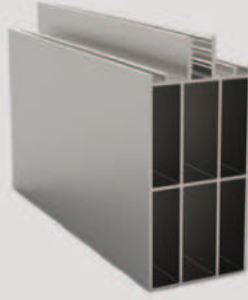
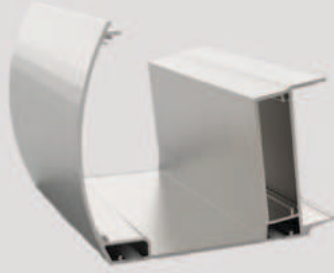
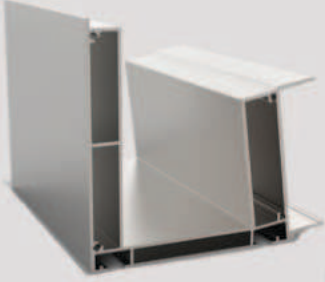

KIŞ BAHÇESİ AKSESUAR SETİ		
MALZEME GÖRSELİ	MALZEME ADI	ADET
	ALT BAĞLANTI PAPUÇ (110X145)	
	ÜST FLANŞ (110X145)	
	ALT BAĞLANTI PAPUÇ(100X100)	
	ÜST FLANŞ (100X100)	
	PLASTİK SU GİDERİ	
	ÜST BASKI İNCE FİTİL ISIYA DAYANIKLI	MT
	CAM ALTI TUTMA FİTİLİ ISIYA DAYANIKLI	MT
	ARKA YASSI FİTİL (YAPRAK) TOZ KAPATMA ISIYA DAYANIKLI	MT
	DÜZ OLUK LAZER TAKIM	2 ADET
	OVAL OLUK LAZER TAKIM	2 ADET
	ARKA KAPAMA BAĞLANTI LAZER TAKIM	2 ADET



BİOKLİMATİK PROFİL SİSTEMLERİ

BIOCLIMATIC AWNING PROFILES

BİOKLİMATİK PROFİL LİSTESİ			
	PROFİL GÖRSELİ	DEMSAN KOD	AÇIKLAMA
1		6030	BÜYÜK OLUK PROFİLİ
2		6022	ÖN KAPATMA PROFİLİ
3		6026	BİOKLİMATİK PANEL PROFİLİ
4		6033	BİOKLİMATİK RAY PROFİLİ
5		6035	BİOKLİMATİK RAY EK PROFİLİ
6		6027	200X130 DİREK PROFİLİ
7		6036	200X130 DİREK KAPAK PROFİLİ

BİOKLİMATİK PROFİL LİSTESİ			
	PROFİL GÖRSELİ	DEMSAN KOD	AÇIKLAMA
1		6037	KÜÇÜK RAY PROFİLİ
2		6038	KÜÇÜK RAY KAPAĞI
3		6044	ÖN VE ARKA KAPATMA KAPAĞI
4		6045	ÖN VE ARKA KAPATMA PROFİLİ
5		0217	SEKİZGEN MOTOR BORUSU
6		0219	MOTOR BORUSU DIŞ UZATMA EKİ

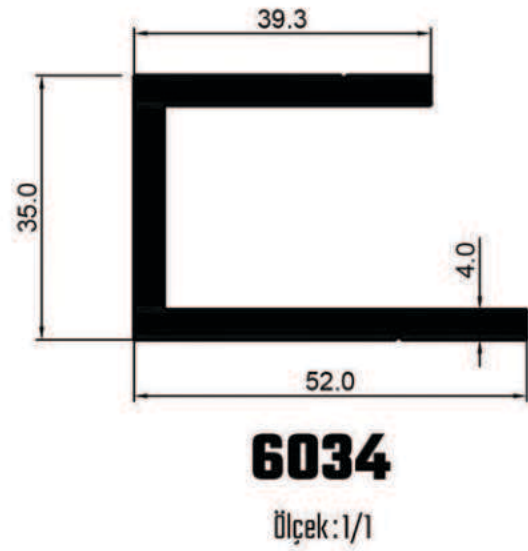
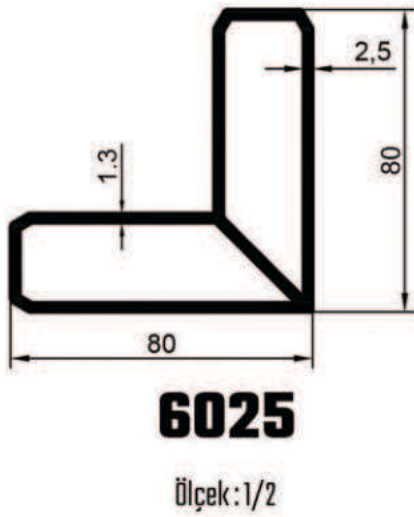
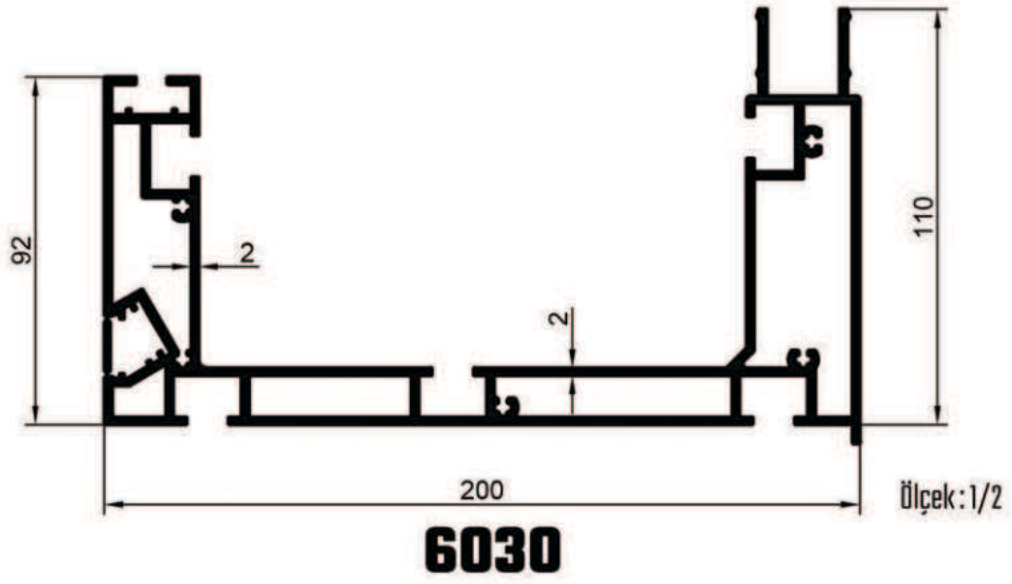

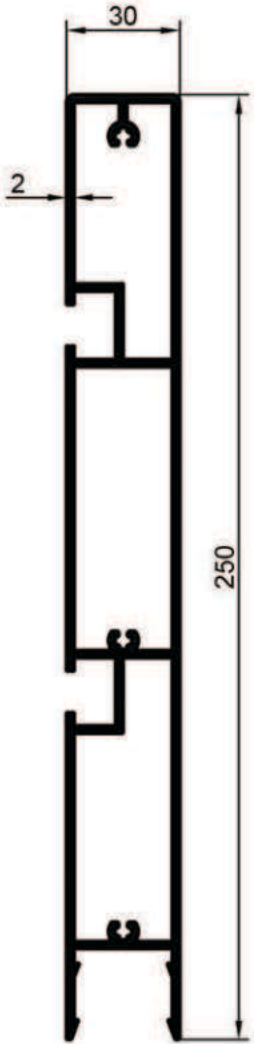

6022

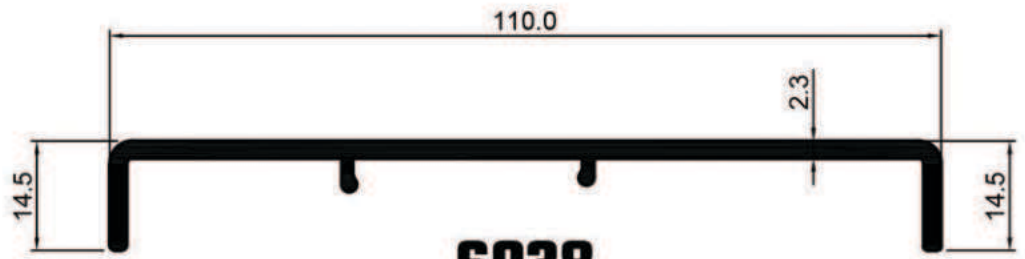

6038

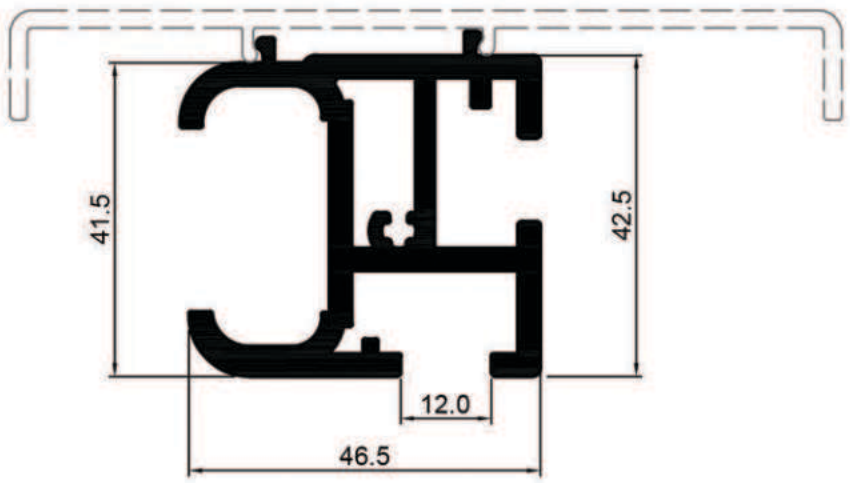

6037

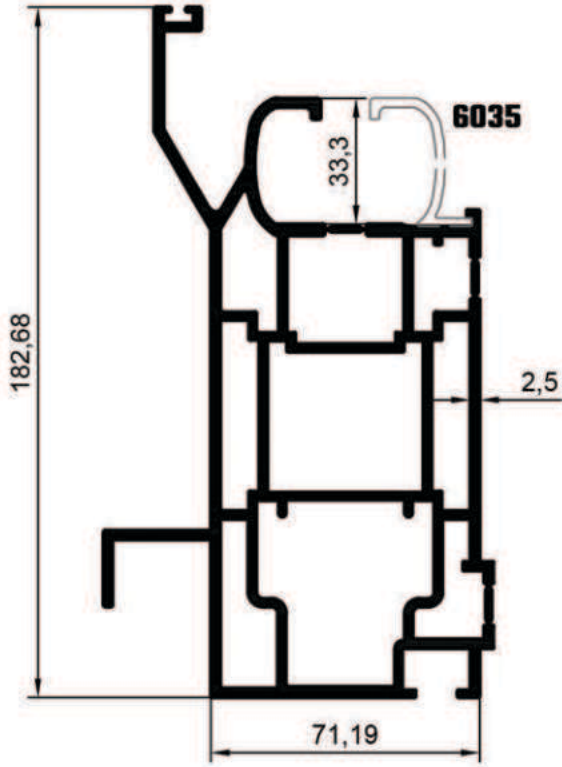

Ölçek: 1/2

6033

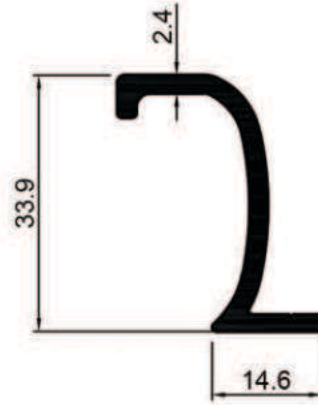

6035

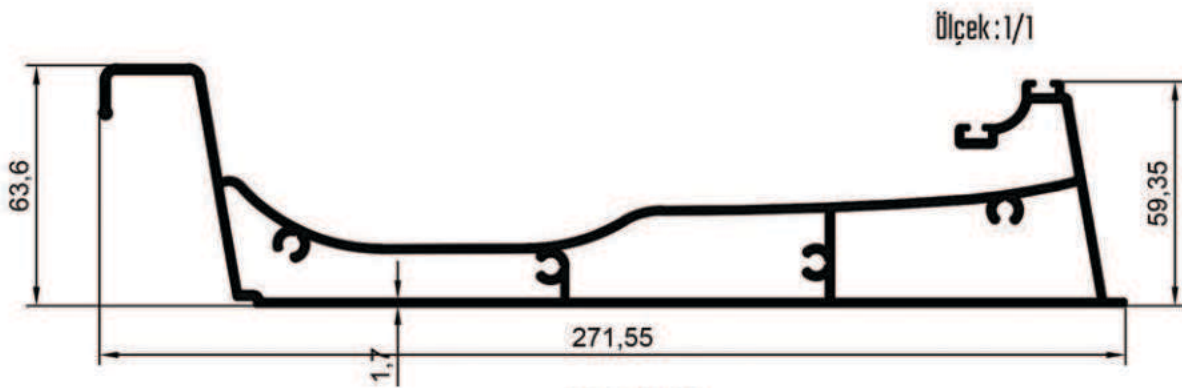

Ölçek: 1/1

6026

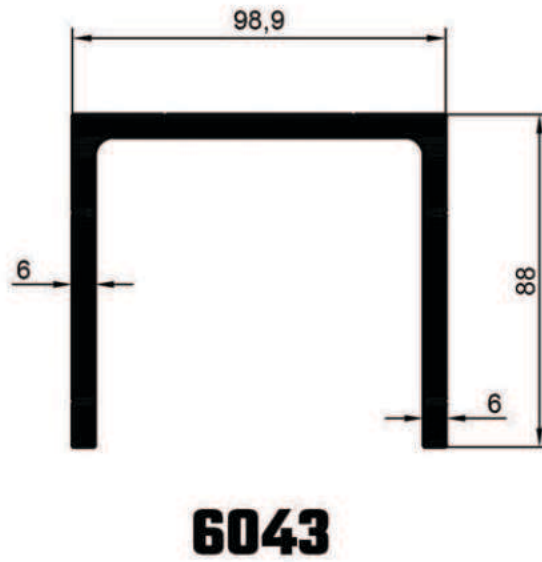
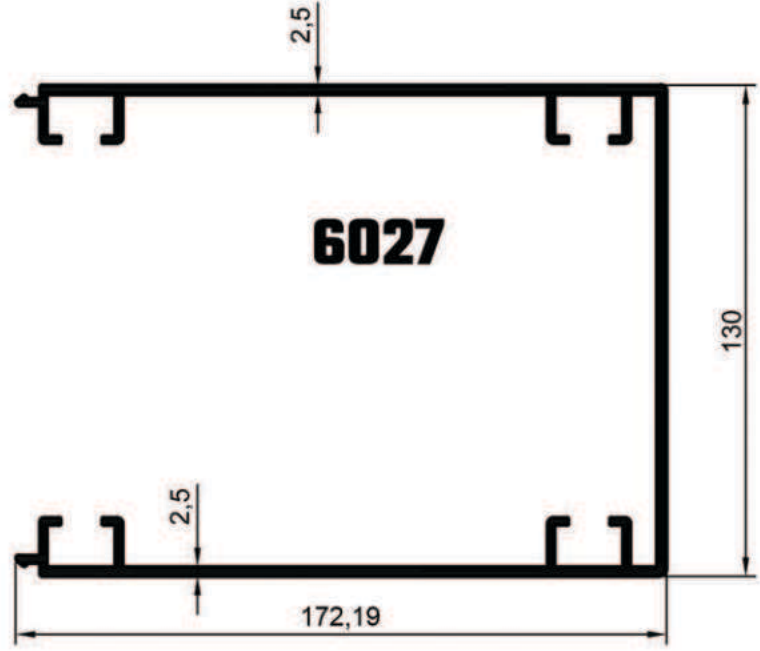
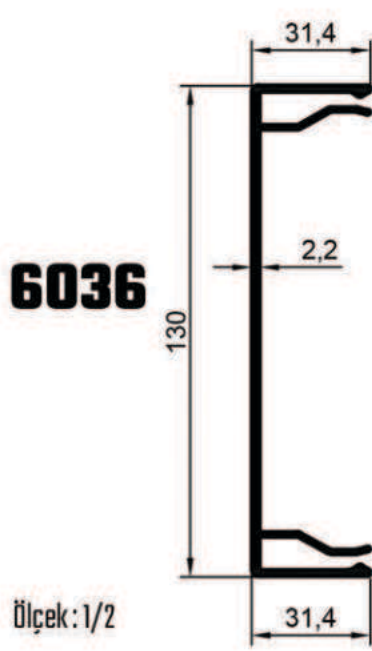



0217

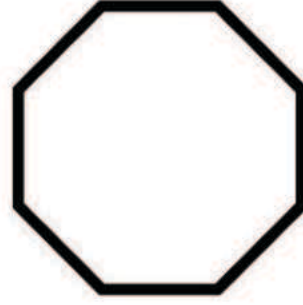

0219

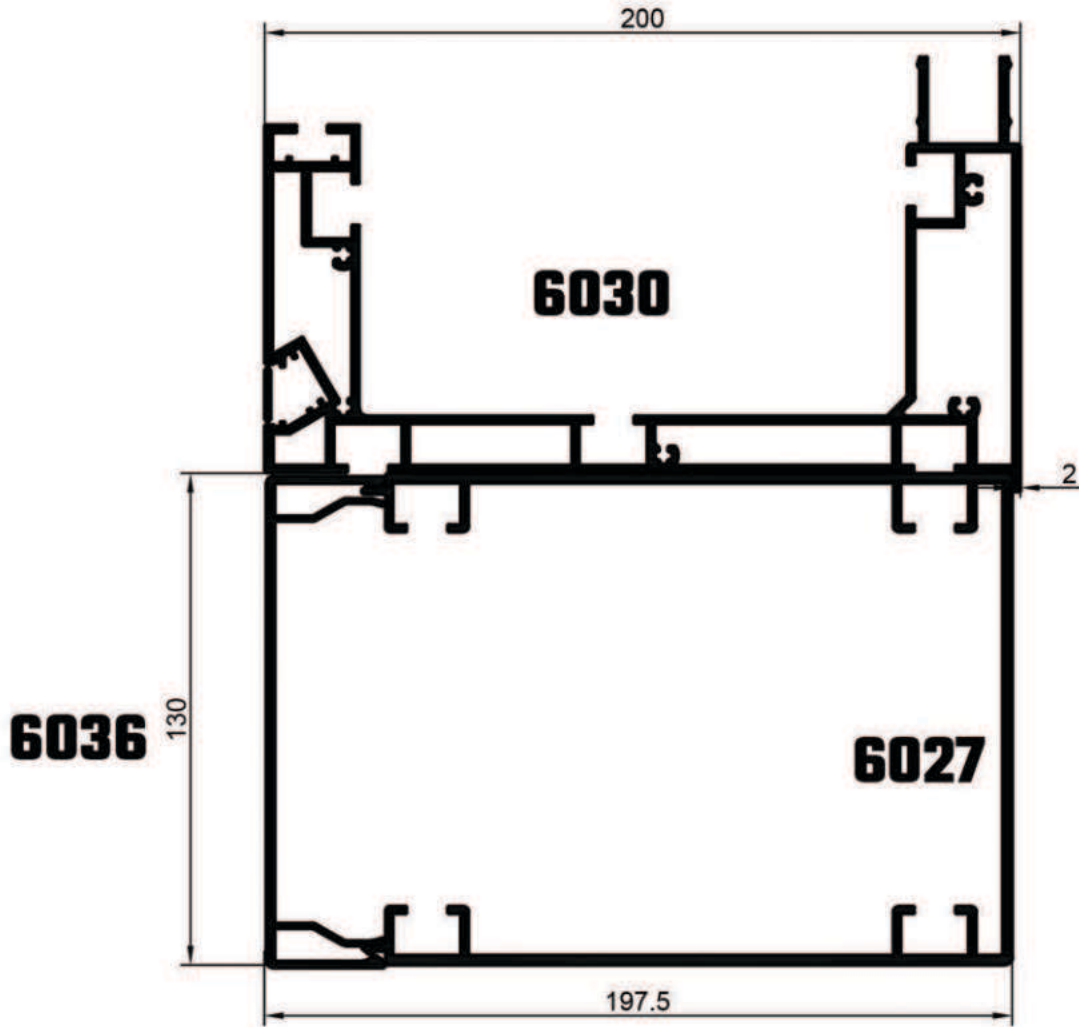

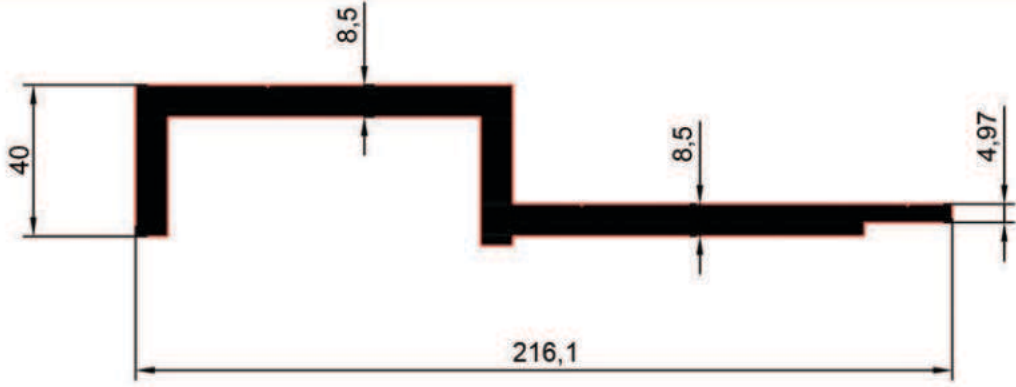

6039

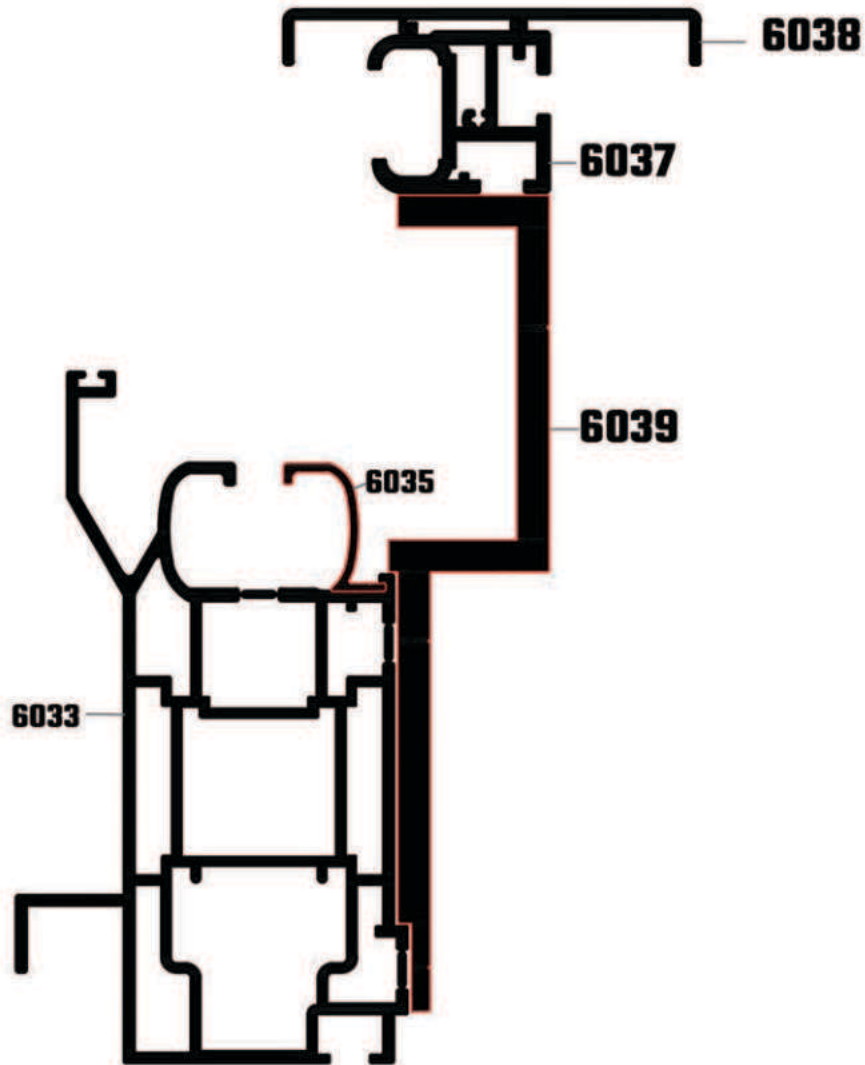



6041

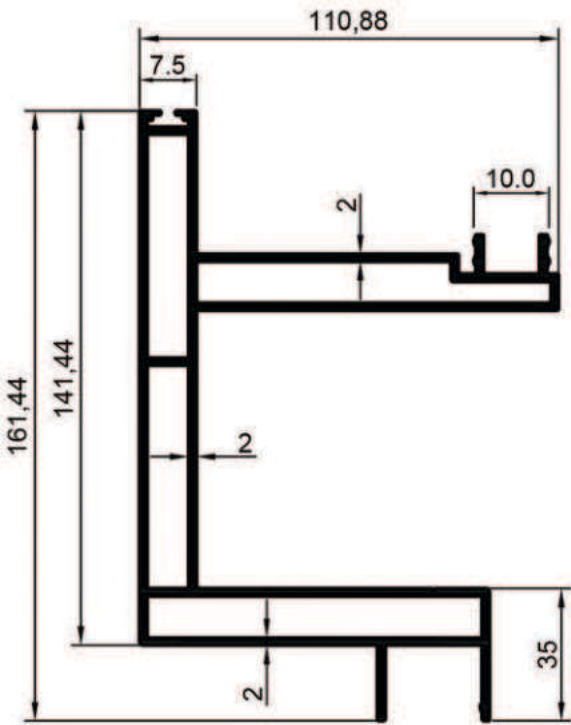

6045

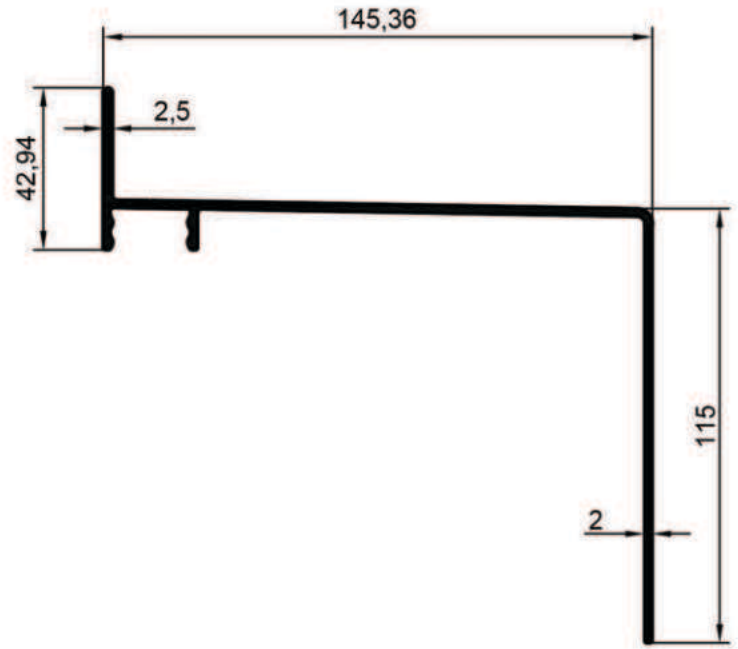

6044



ROLLING PROFİL SİSTEMLERİ

ROLLING ROOF SYSTEM

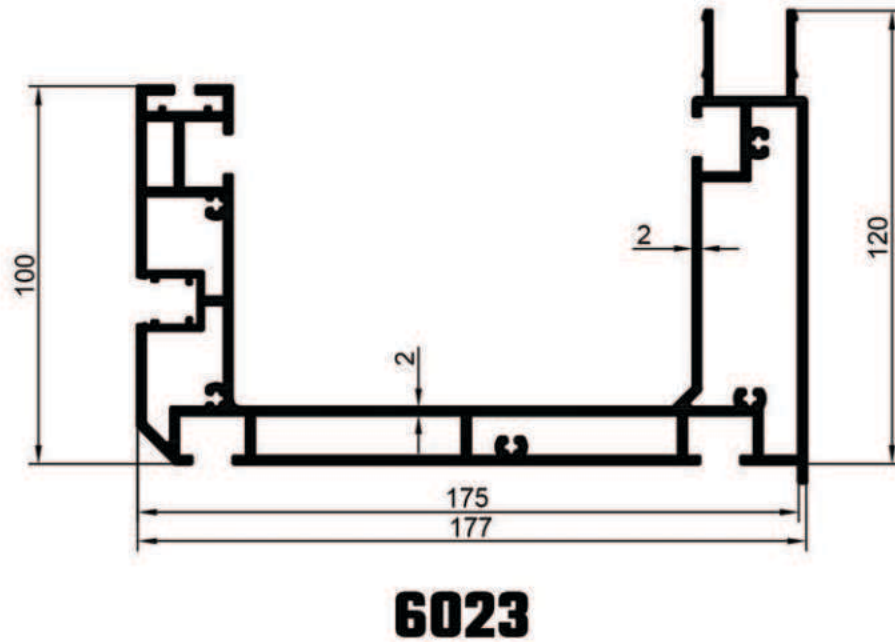
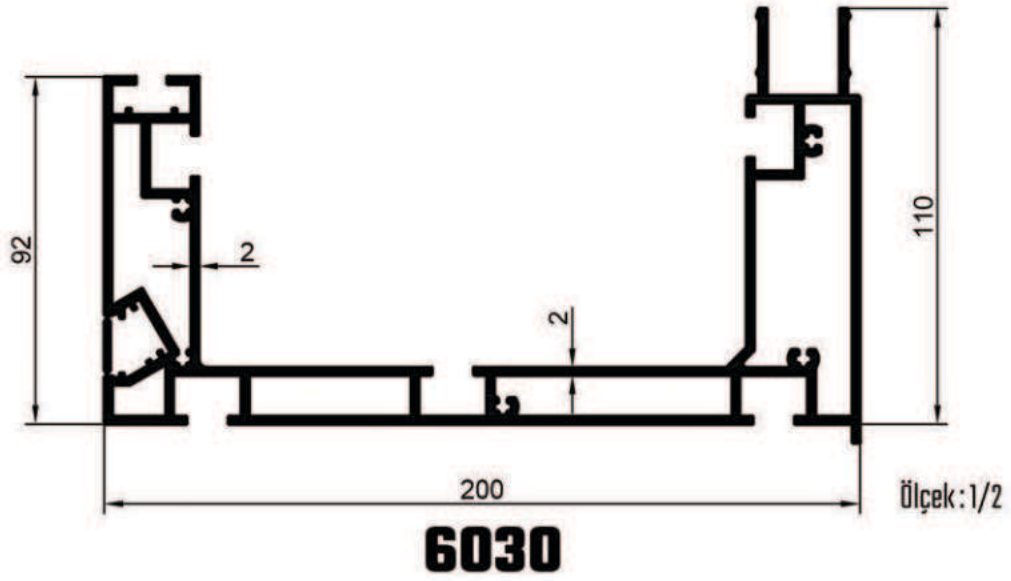

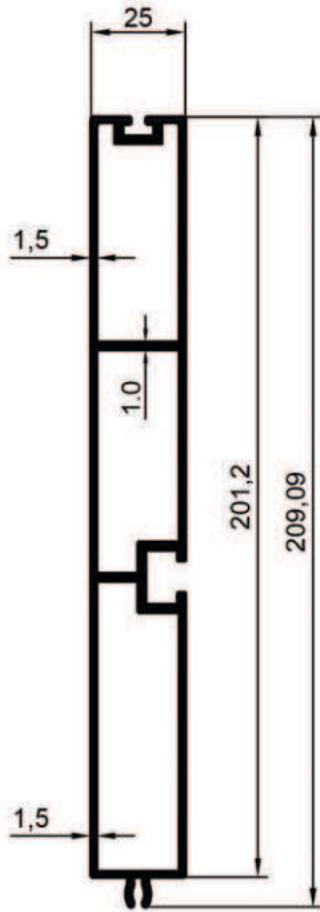

6031

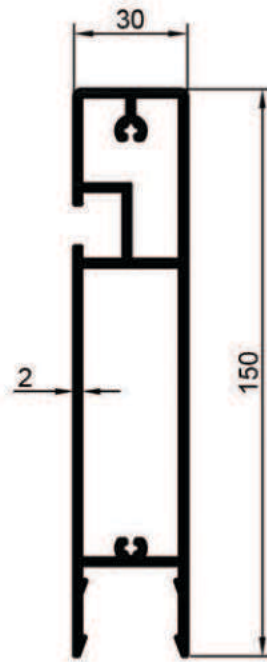

6021

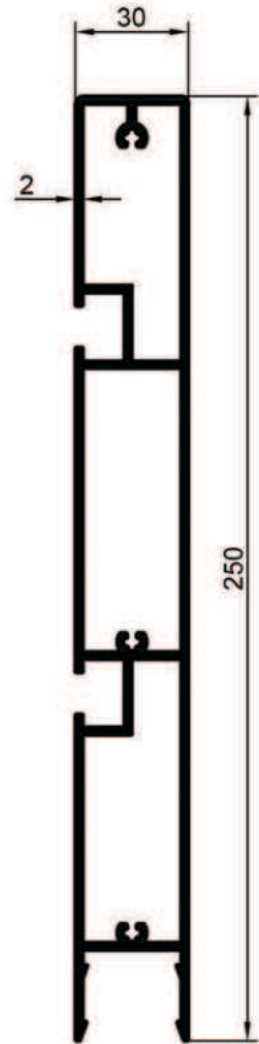

6022

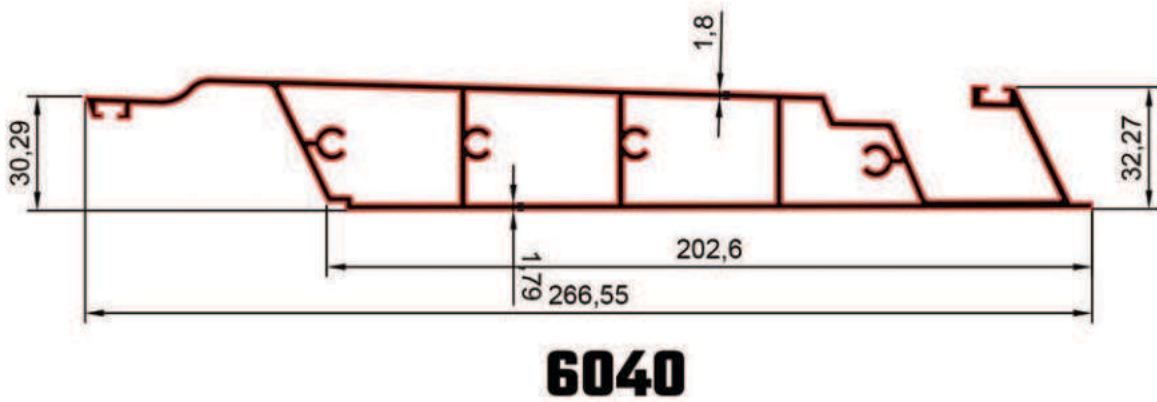
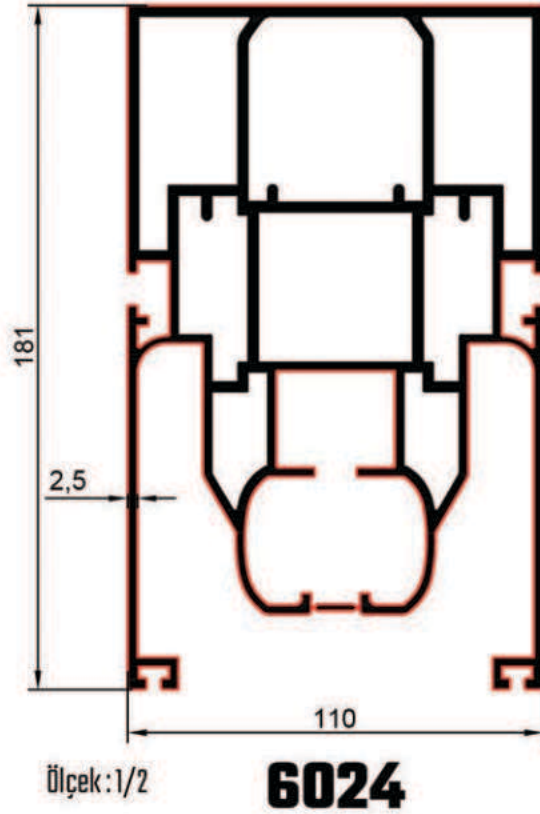

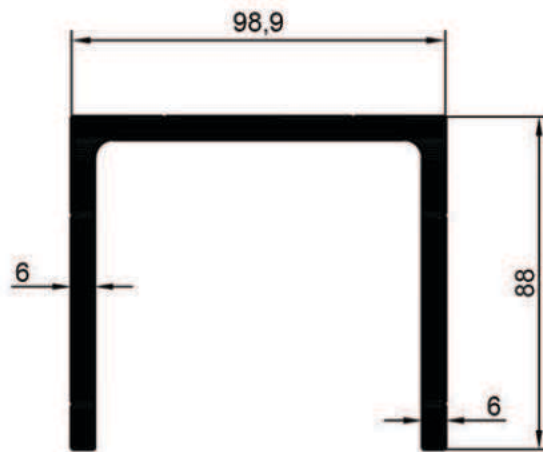
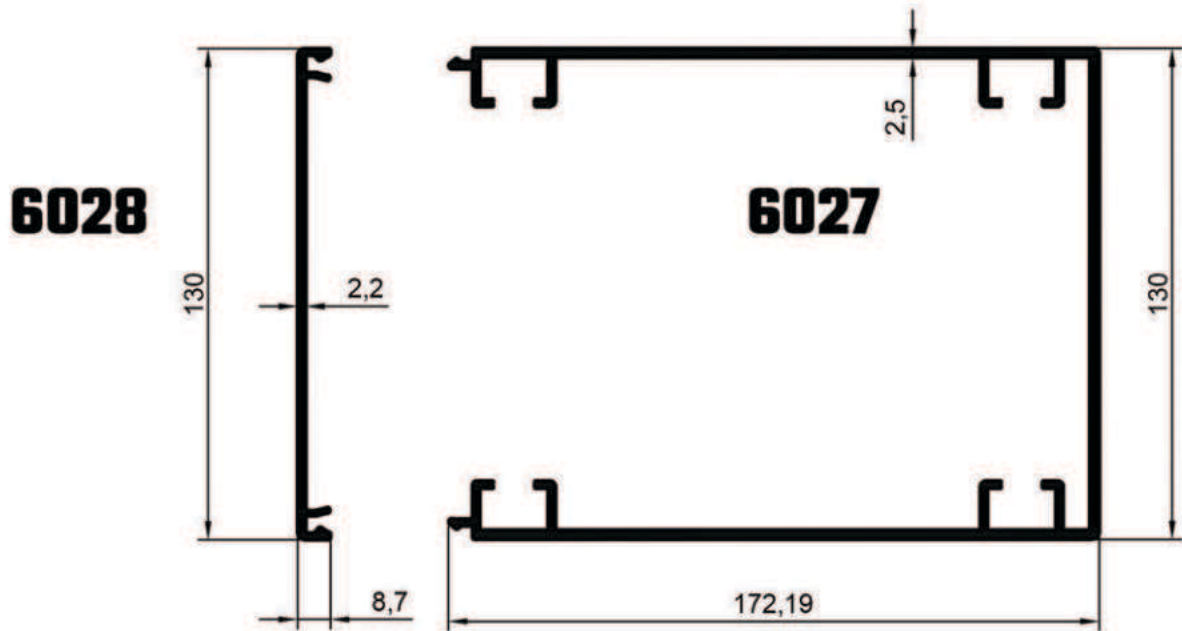

6043

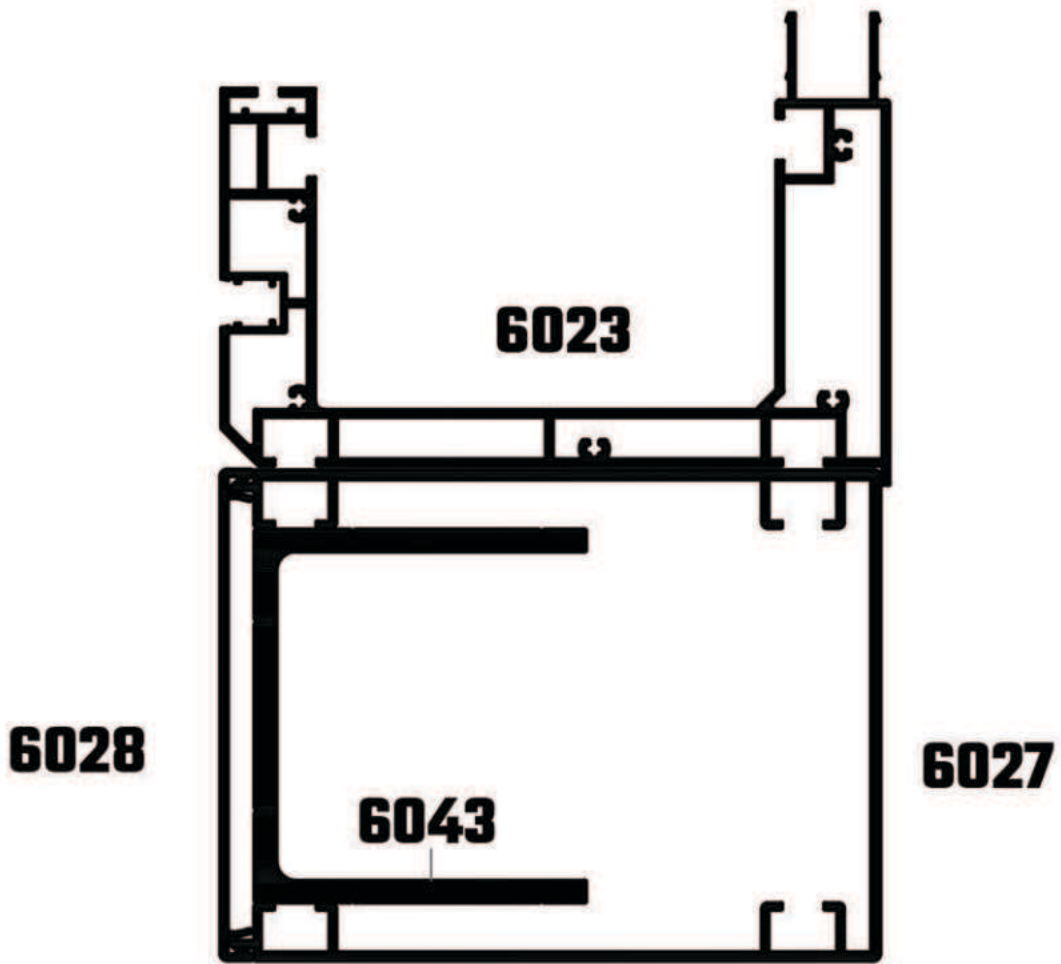



ZIP PERDE PROFİLLERİ

ZIP CURTAIN PROFILES

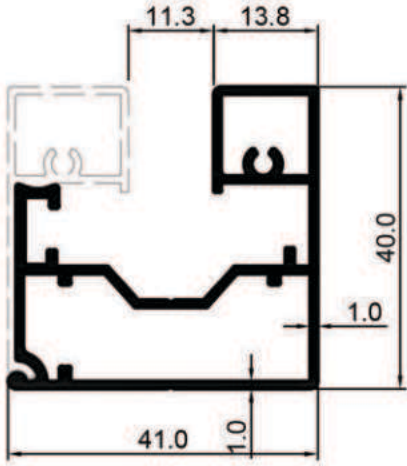

6607

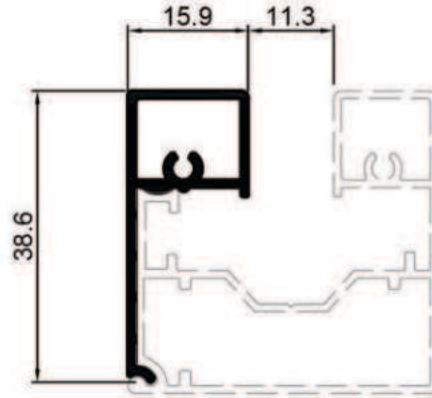

6607

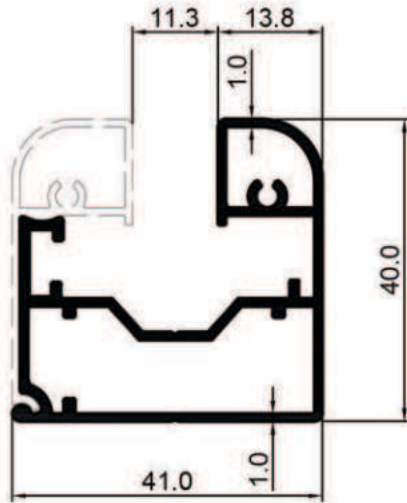

6609

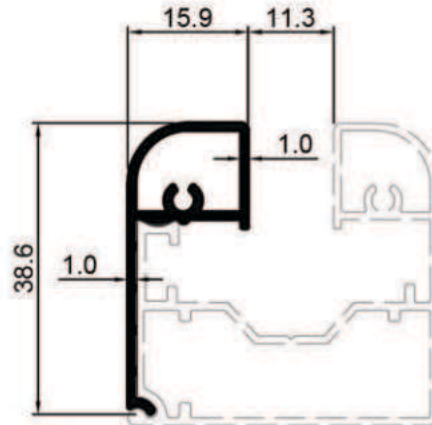

6610

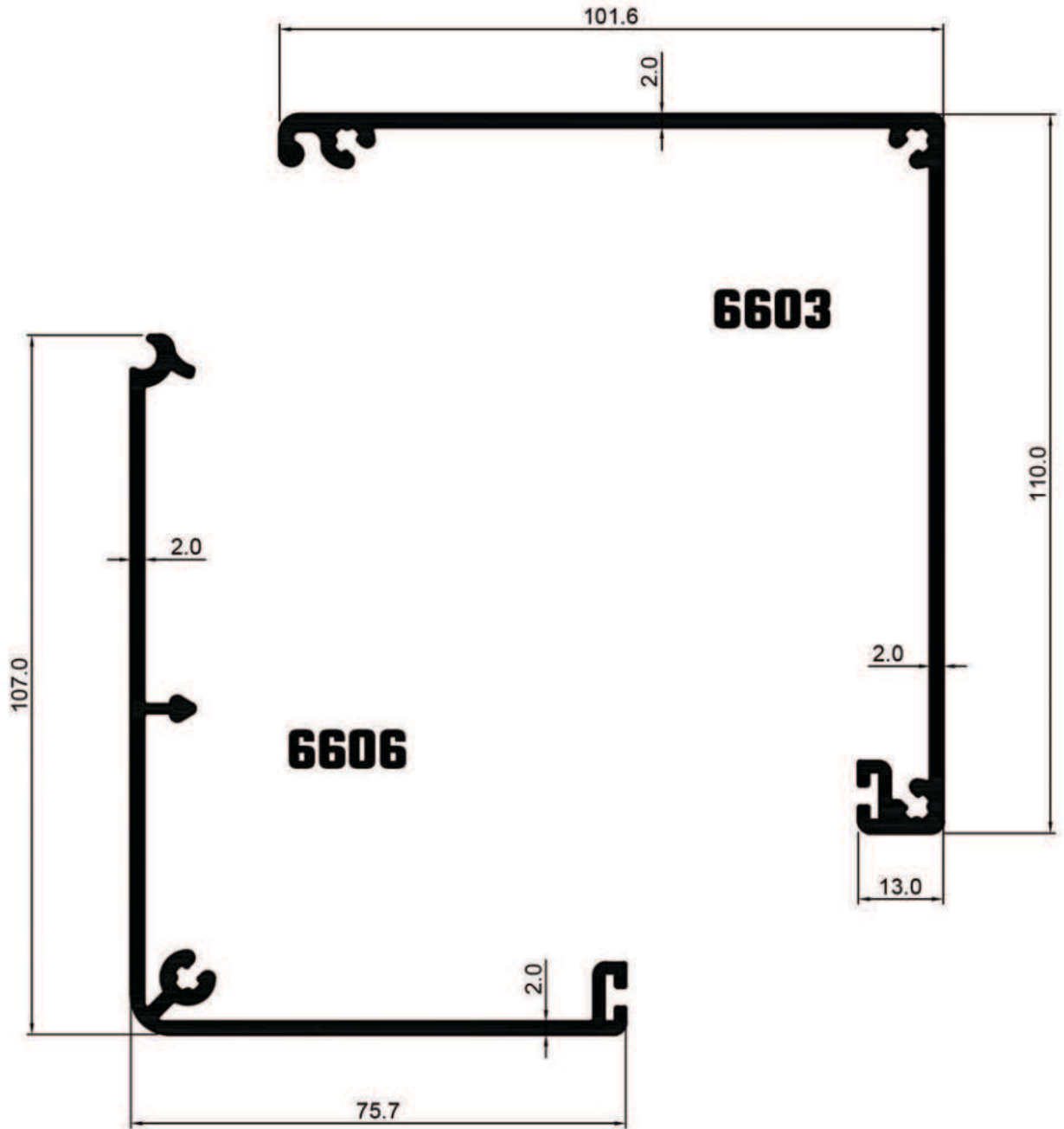

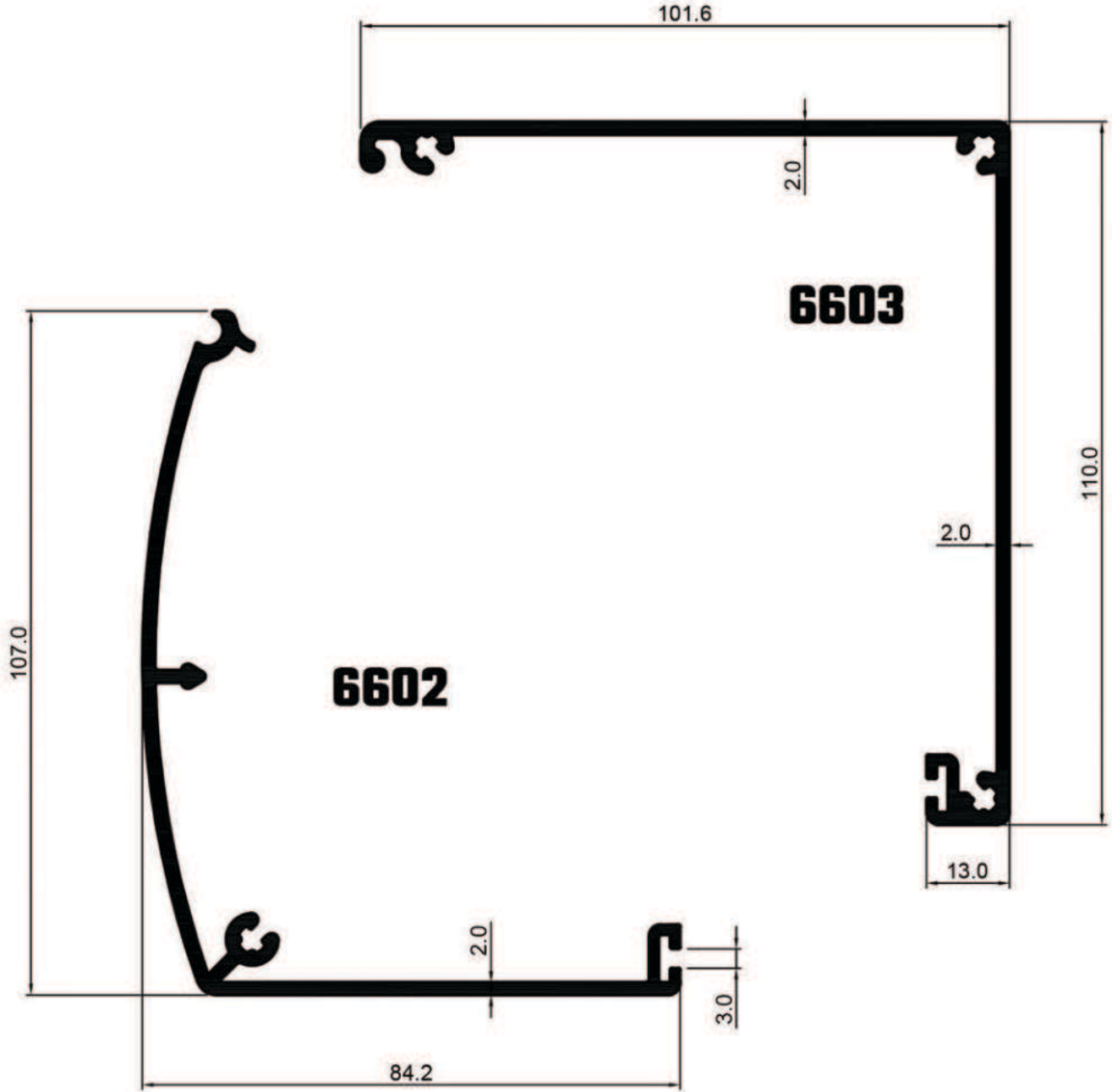

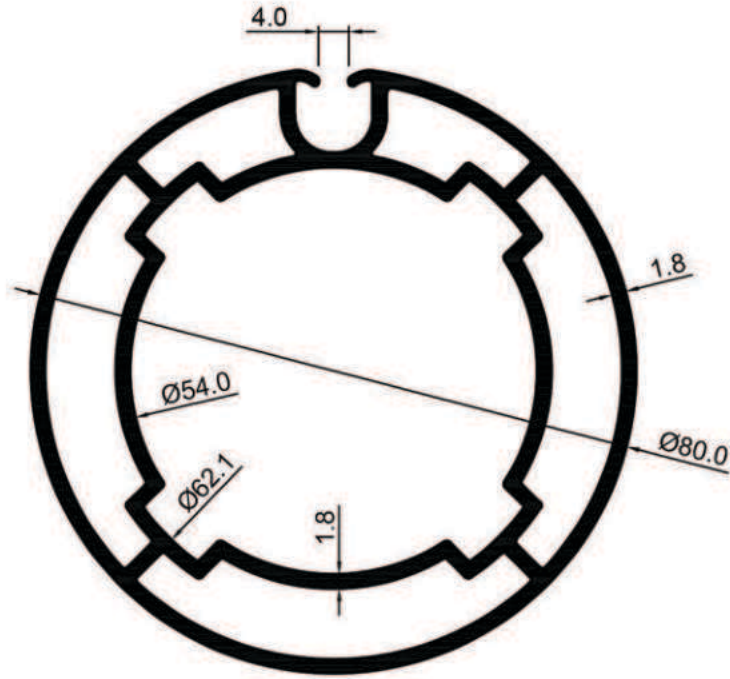

6604

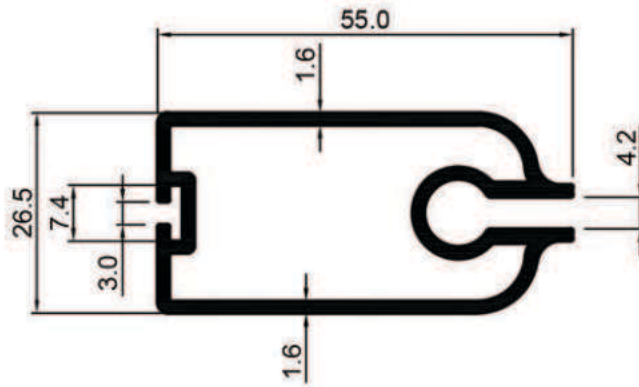

6605



HERMETİK KAPI SÜRME VE OTOMATİK KAPI PROFİLLERİ

HANDRAIL and RAILING PROFILES

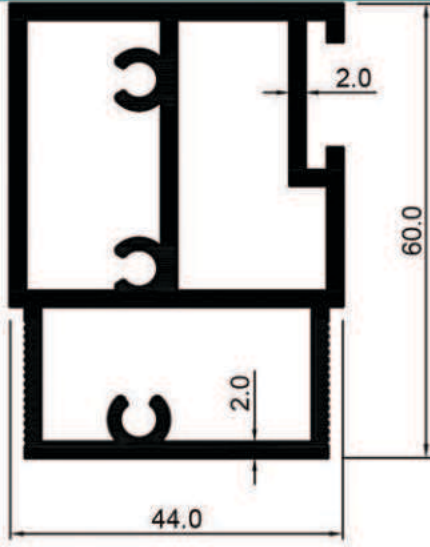

1351

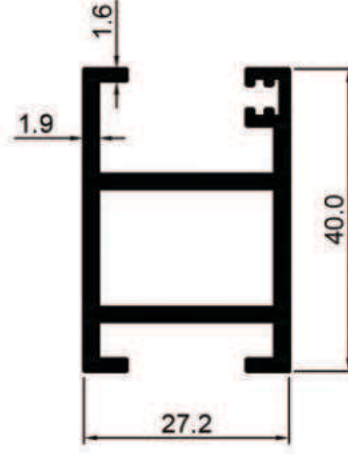

1354

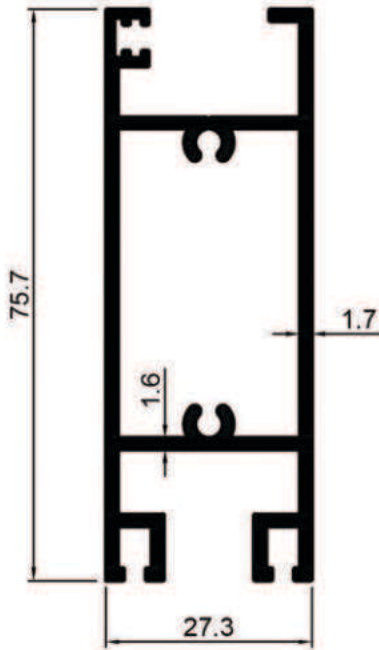

1355

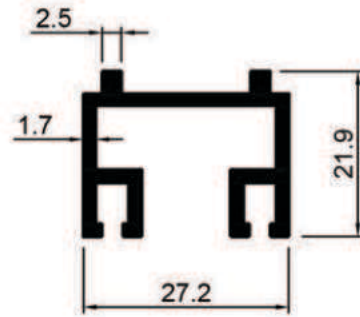

1356

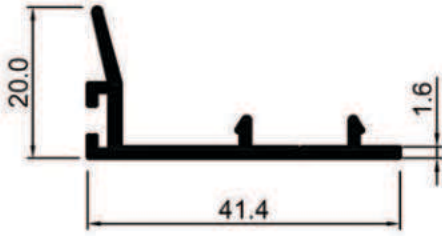

1358



1359

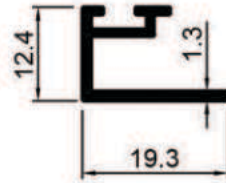

1357



1353

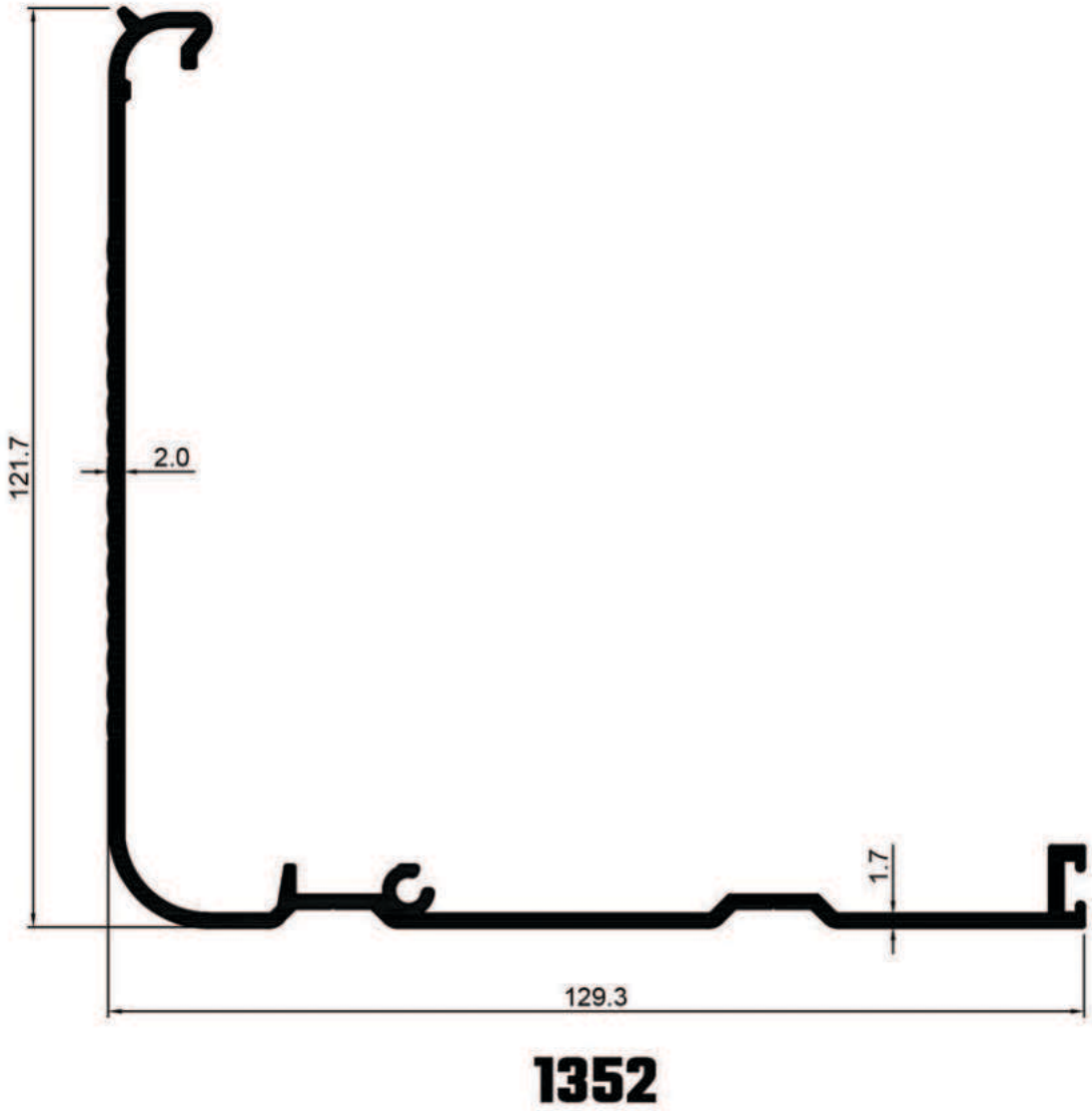



OTOMOTİV PROFİLLERİ

AUTOMOTIVE PROFILES

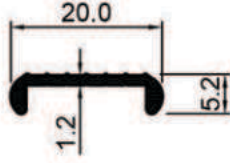

2401

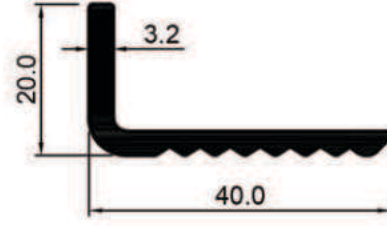

2404

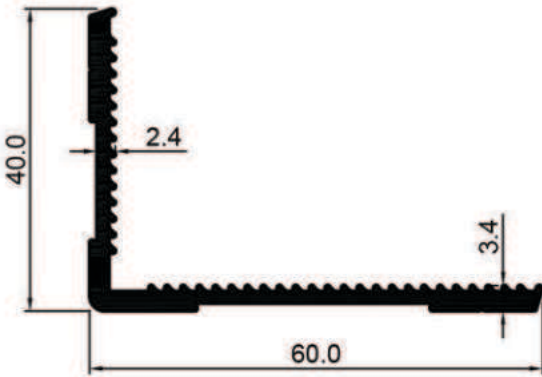

2403

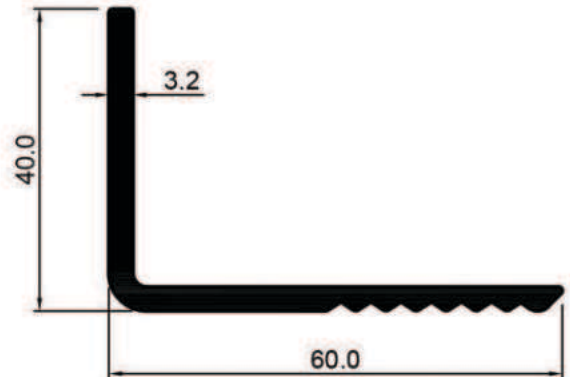

2405

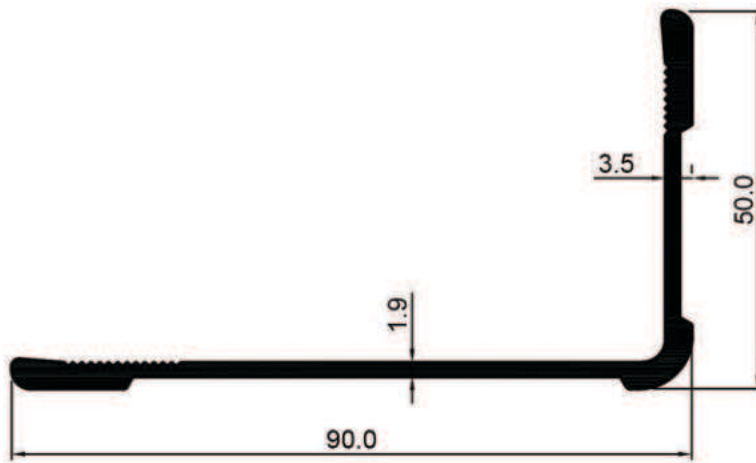

2406

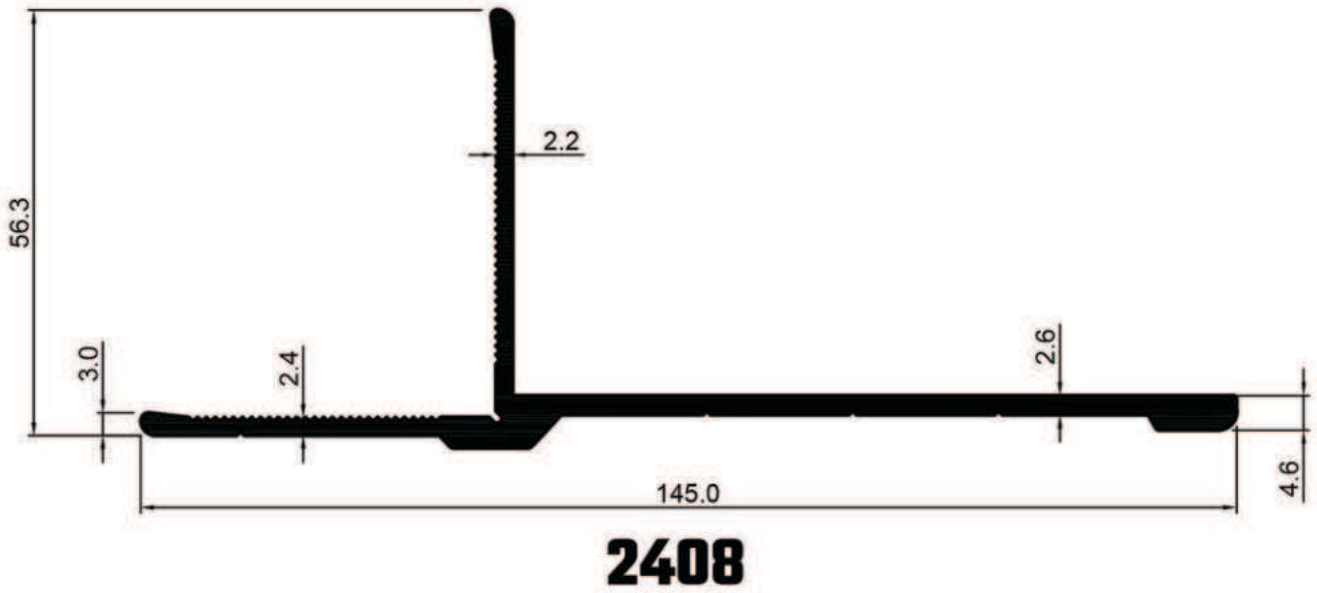
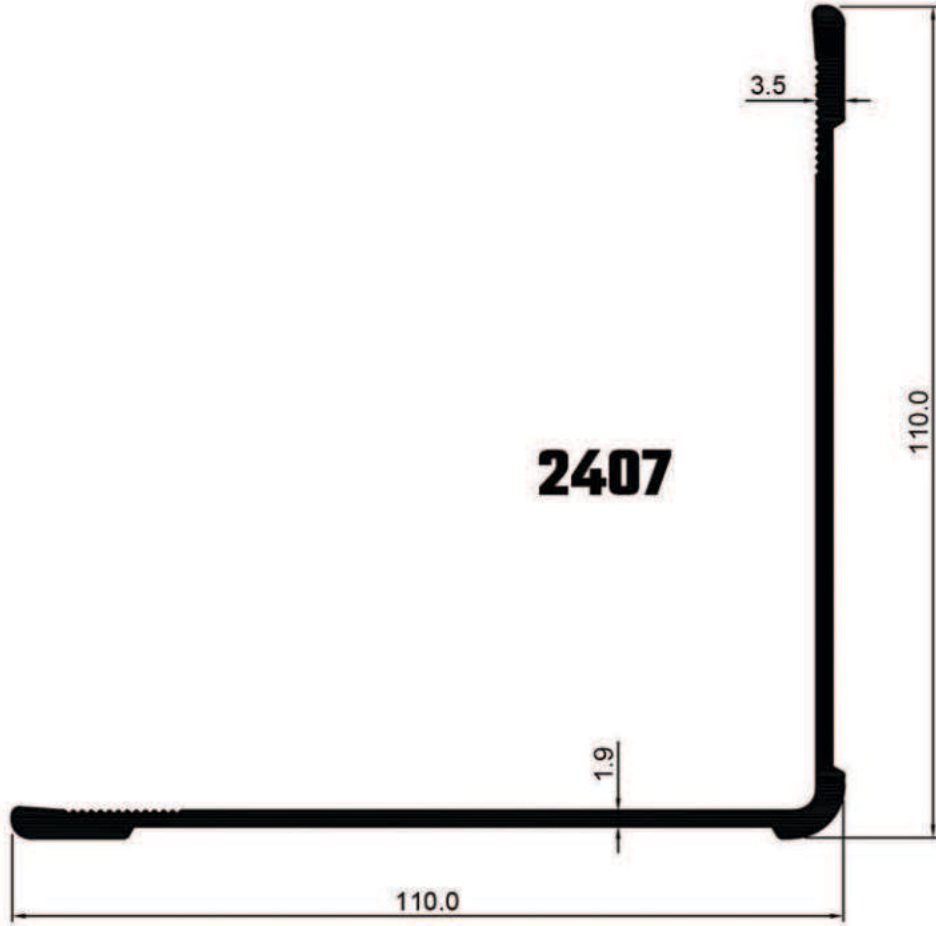

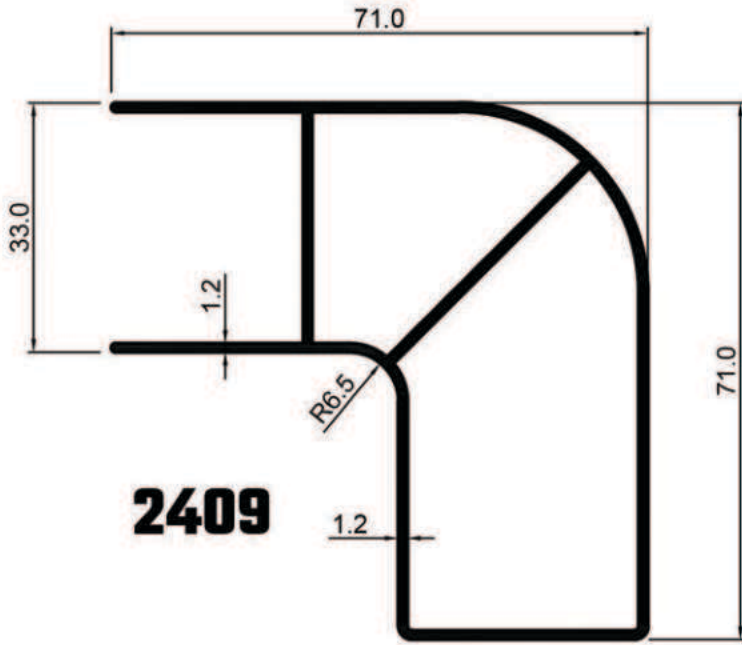

2409

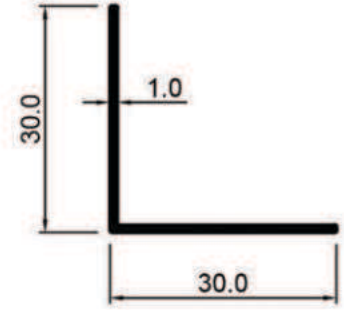

3007



4317

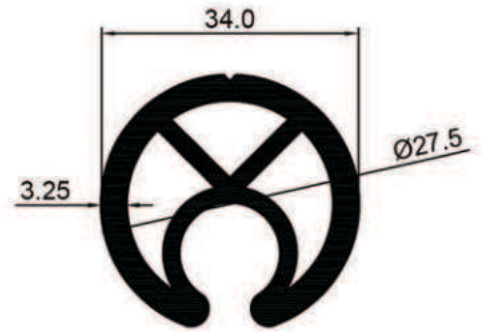

4318

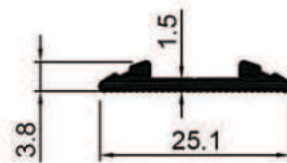

4381

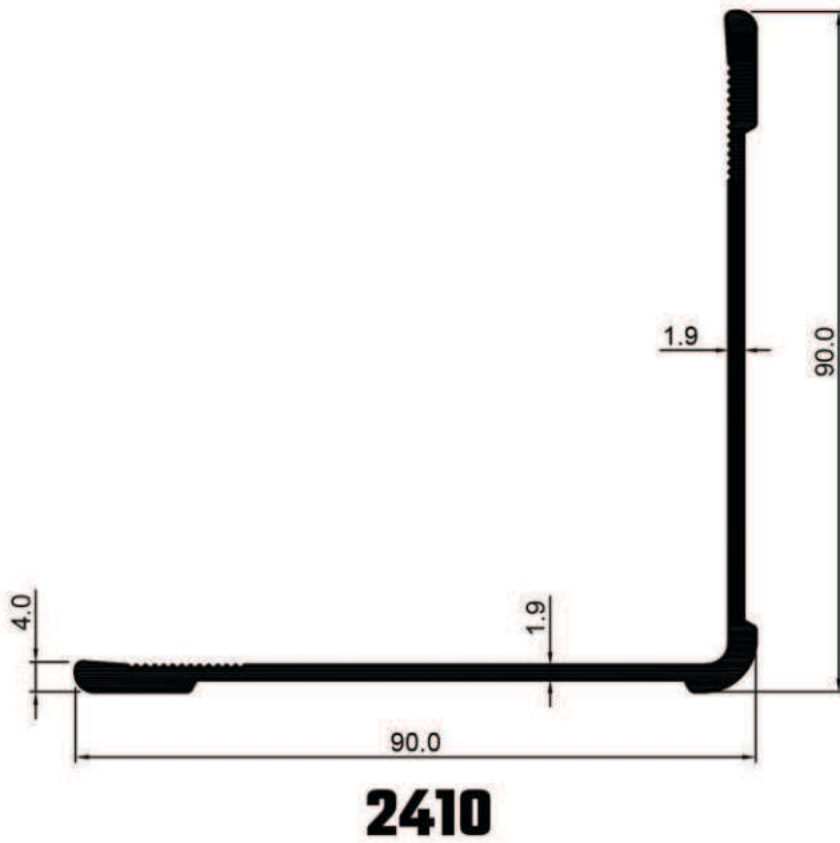
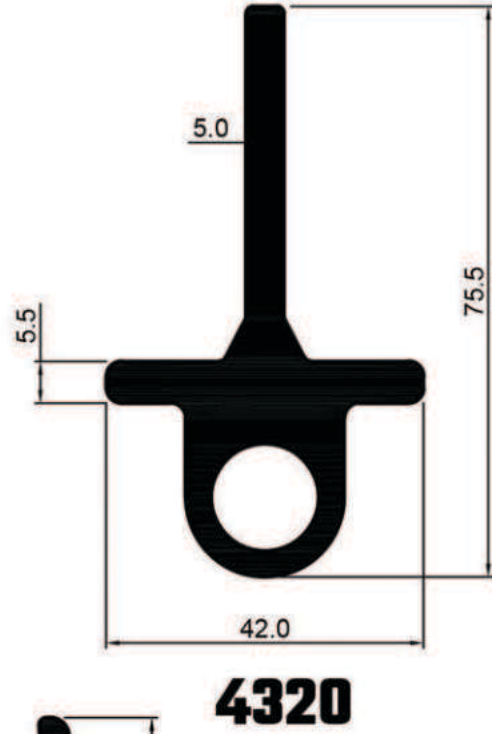
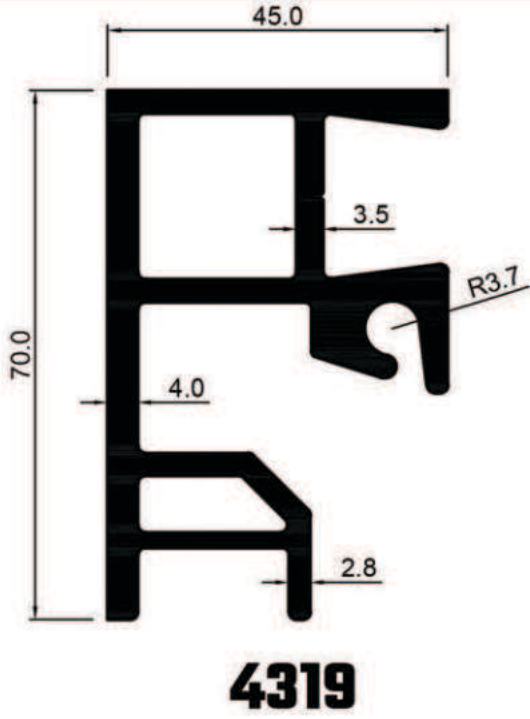

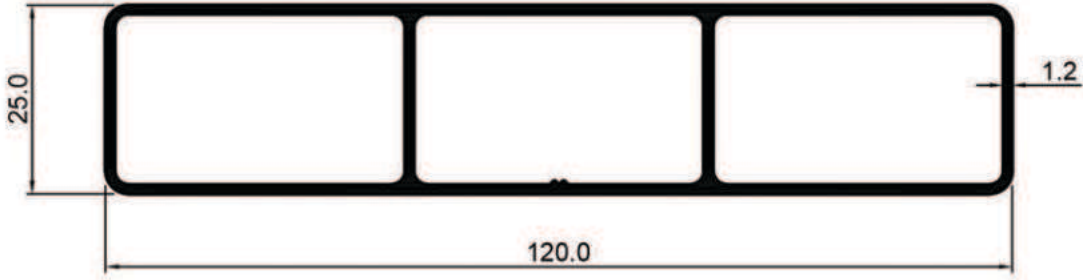

4358

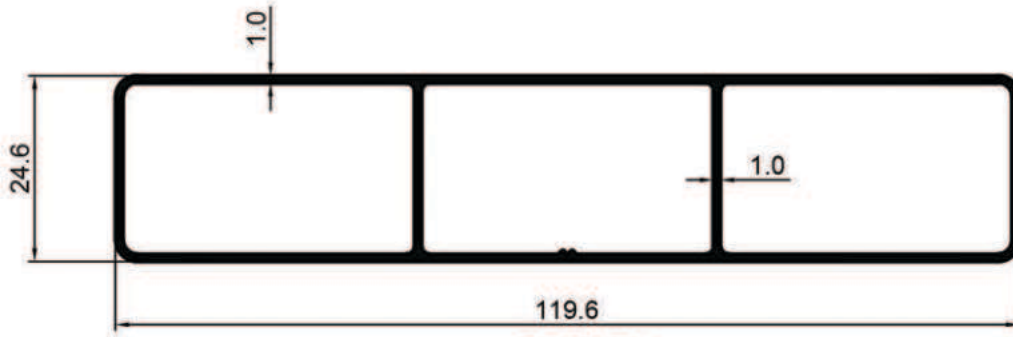

2414

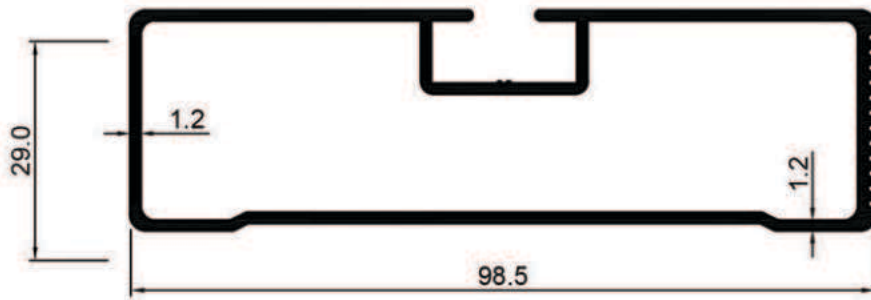

4360

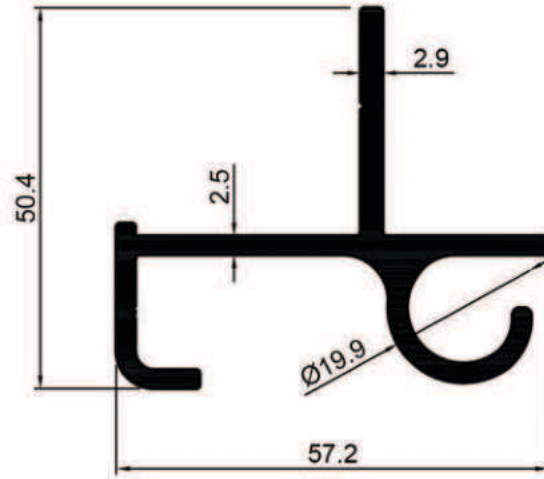

4359



2411

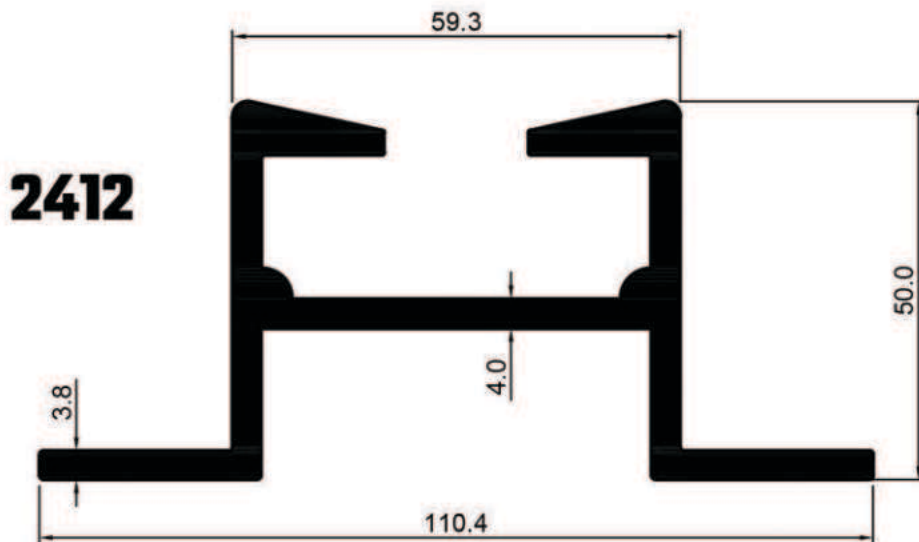

2412



SOĞUTMA PROFİLLERİ

COOLING PROFILES

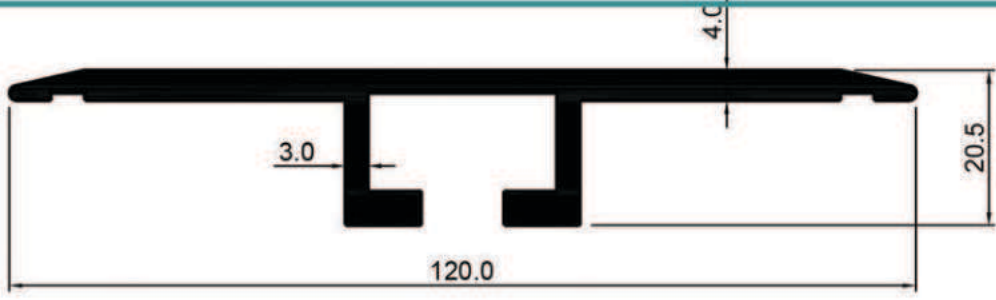

0750

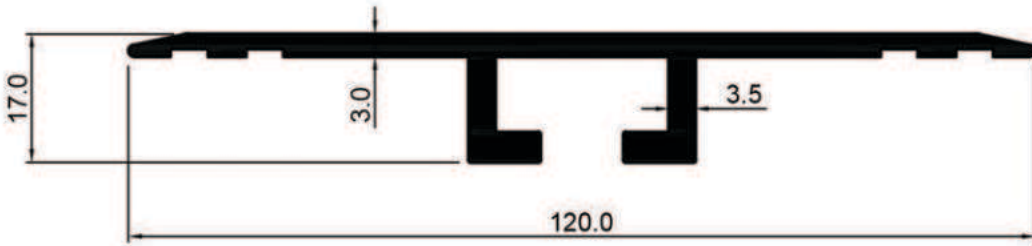

0755

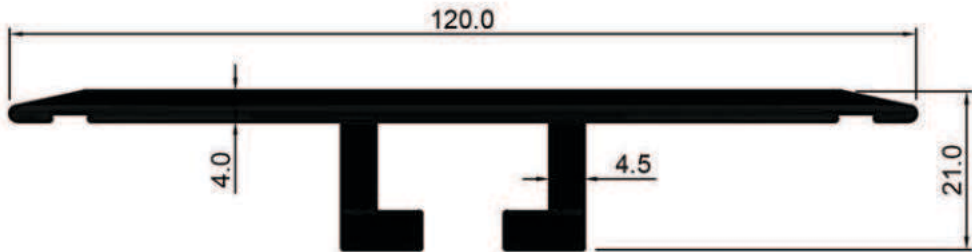

0770

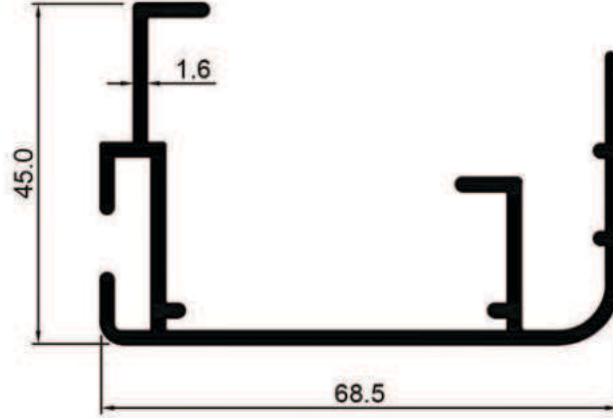

0753

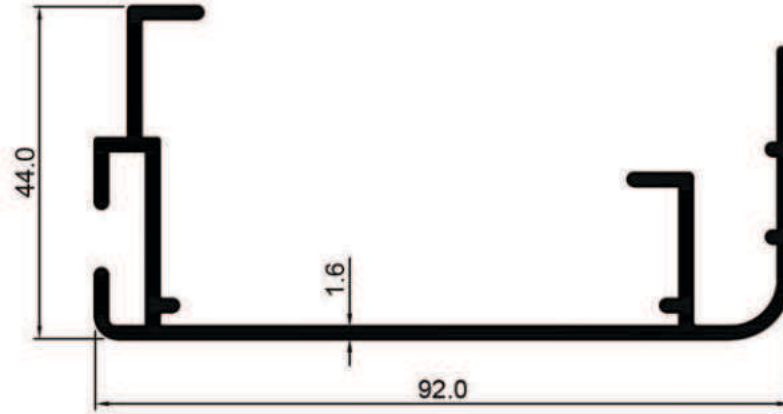

0751

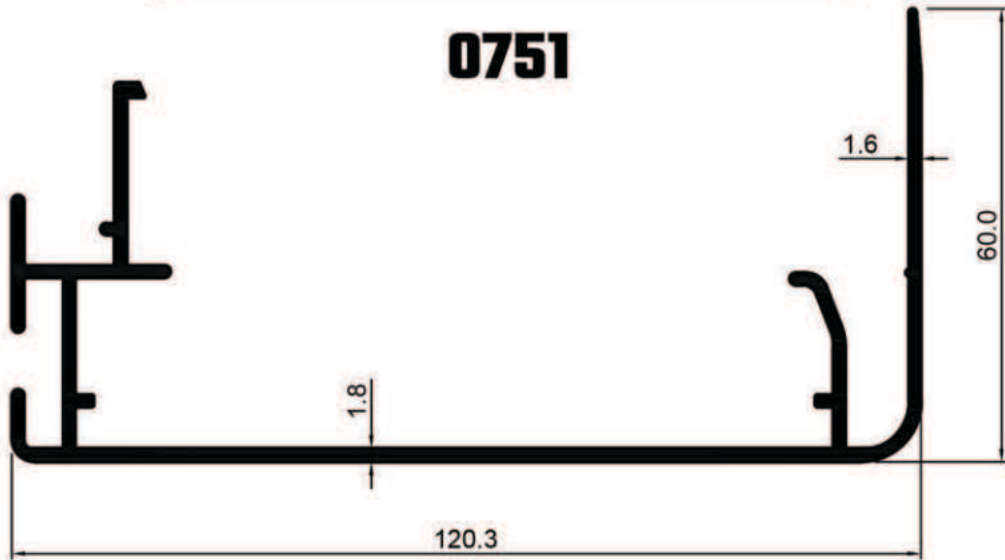

0754

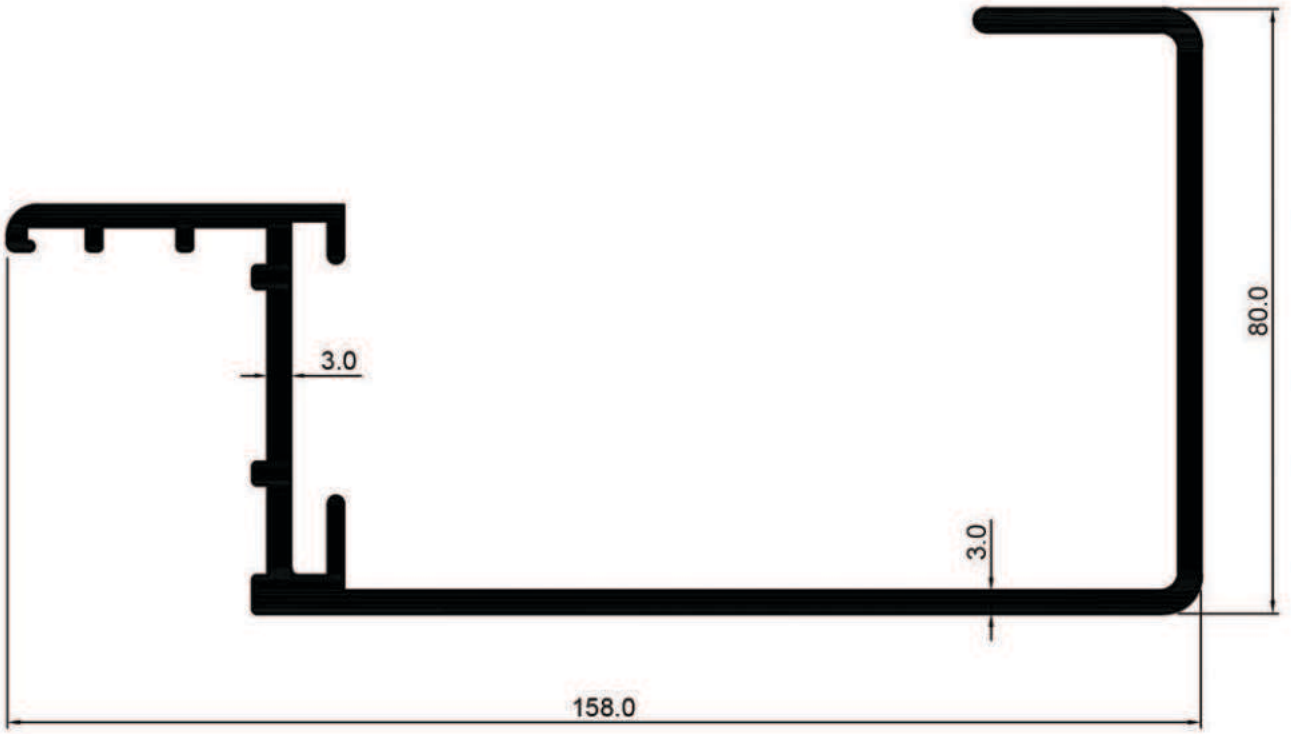

0771

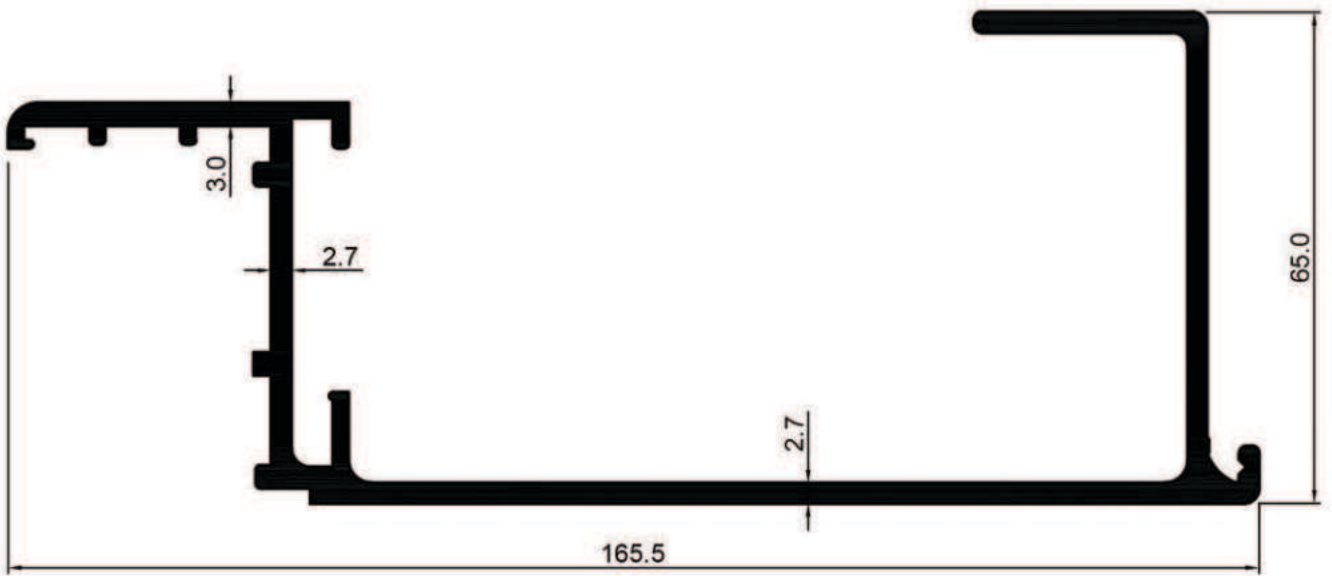

0759

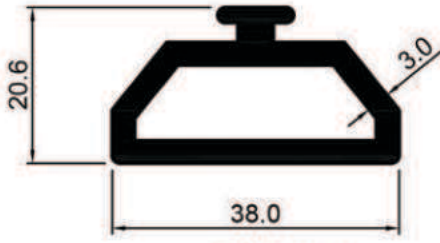

0760

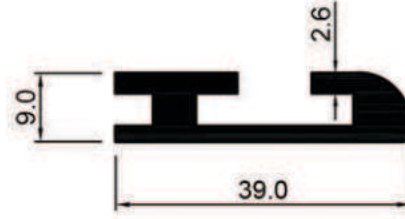

0764

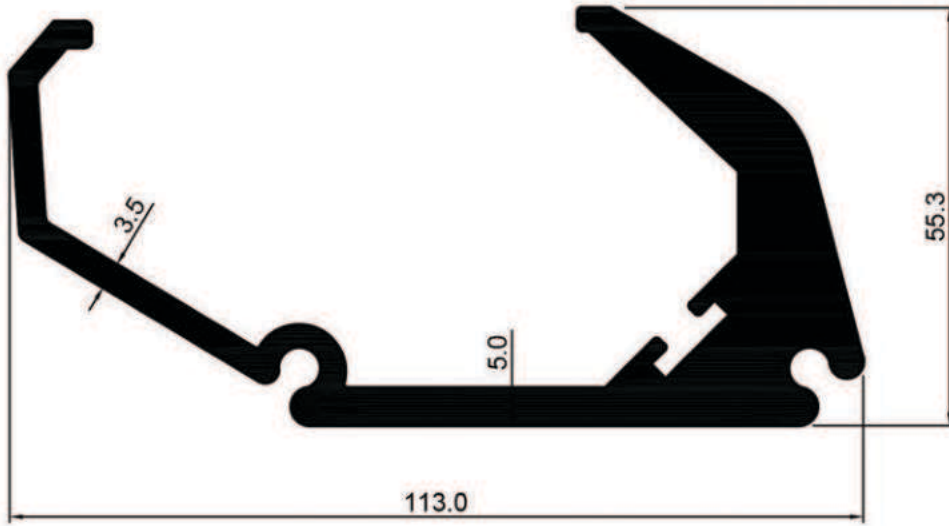

0761

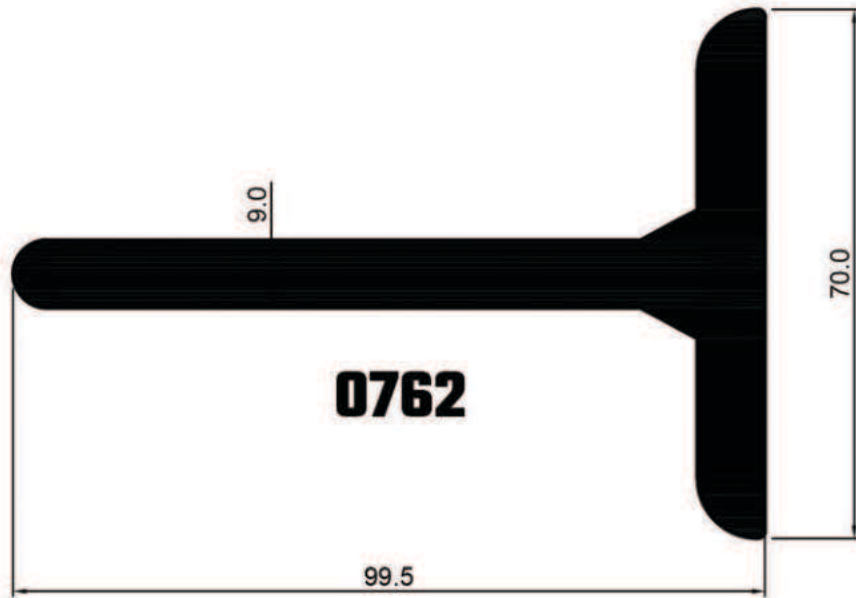

0762

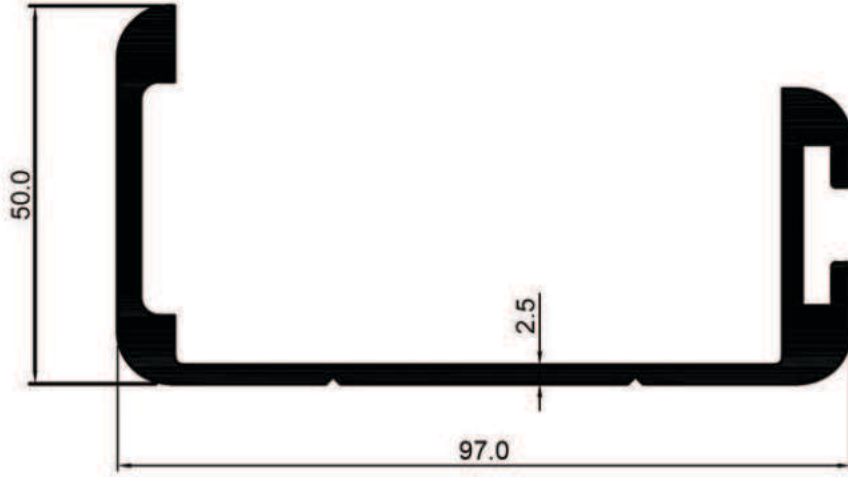

0763

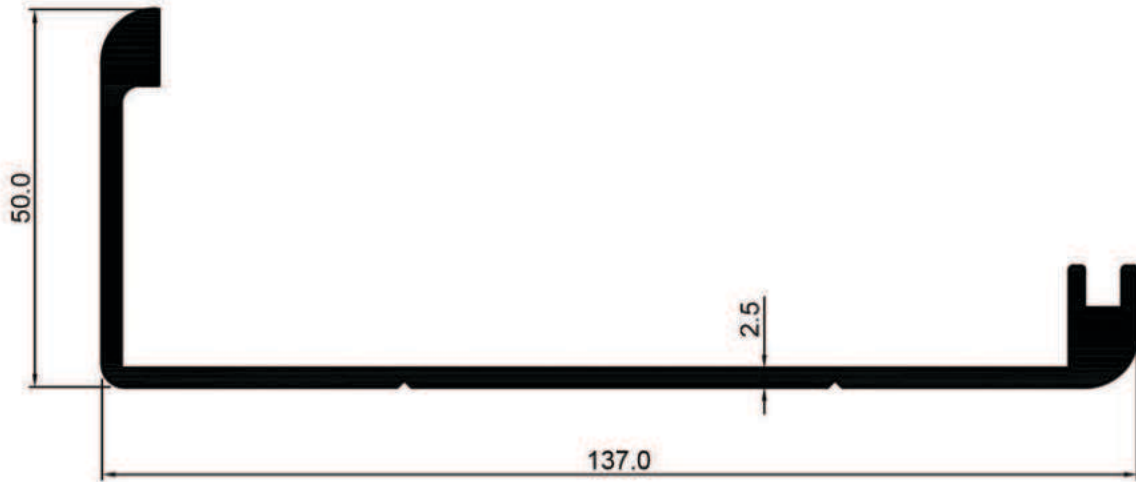

0765

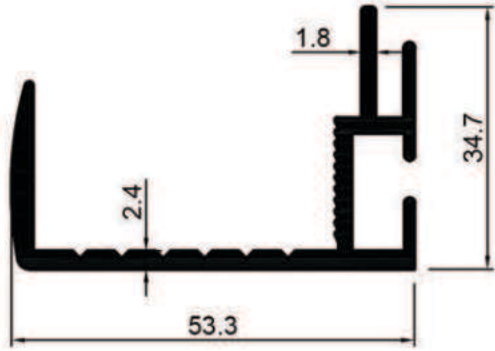

0766

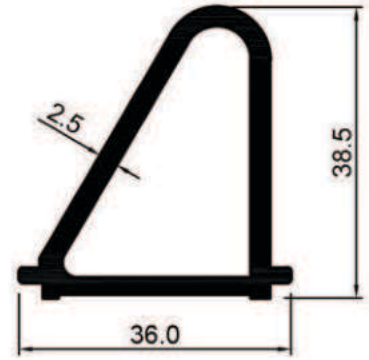

0758

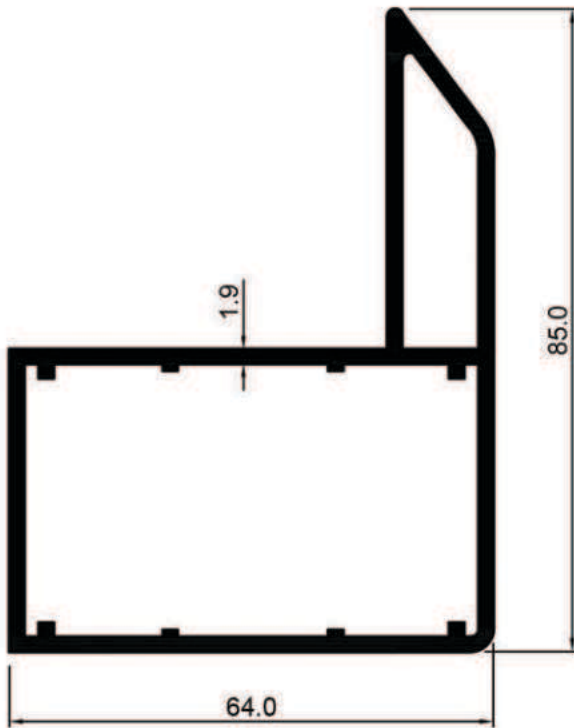

0767

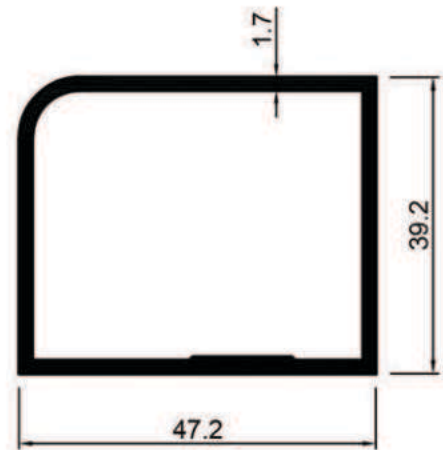

0768

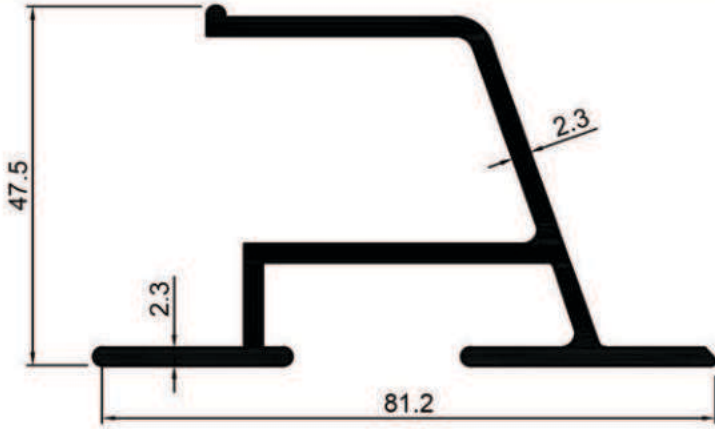

0769

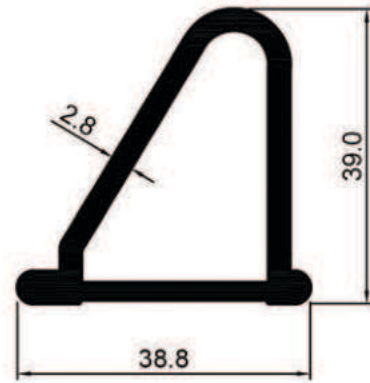

0772

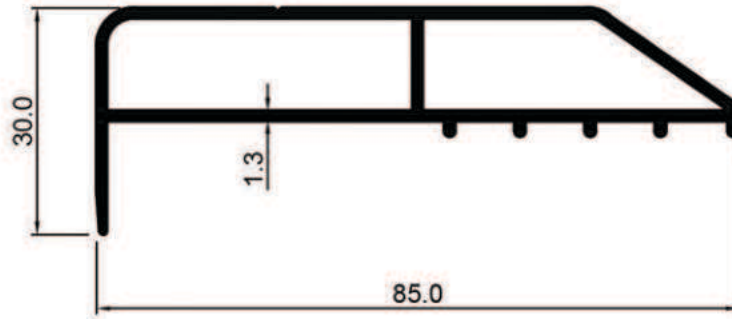

0752

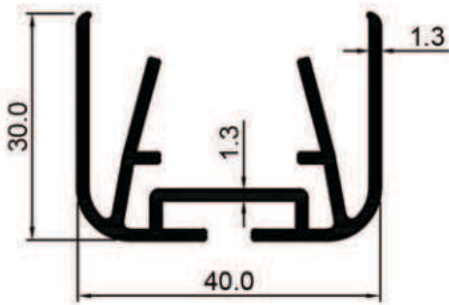

0774

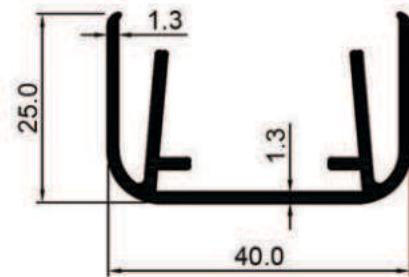

0773

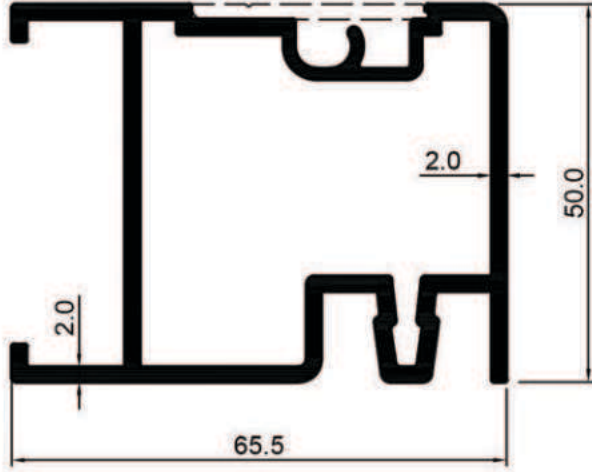

0757

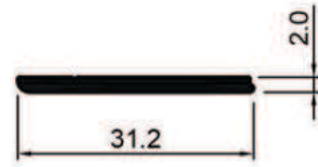

0756

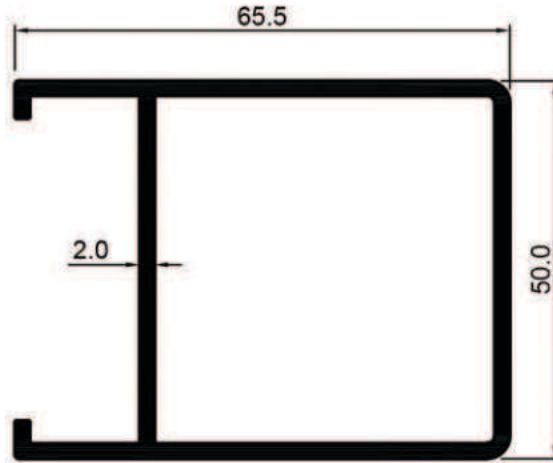

0775

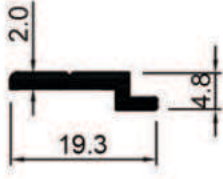

0776

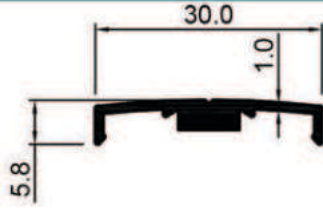

0777



0778

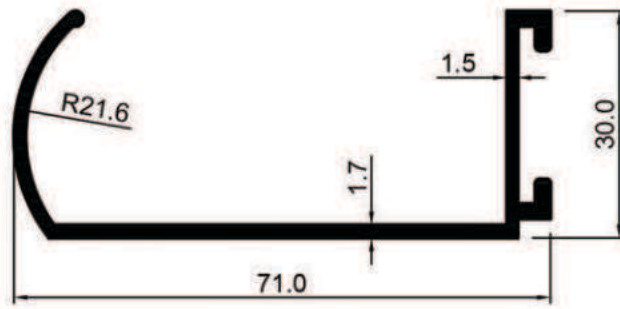

0779

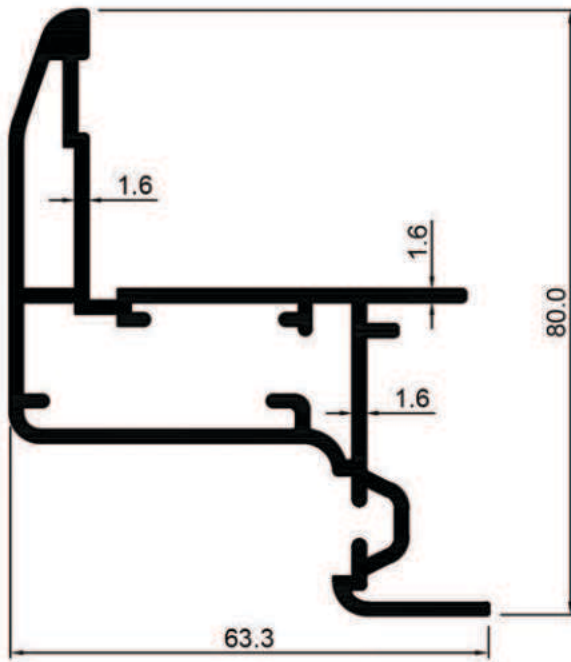

0780

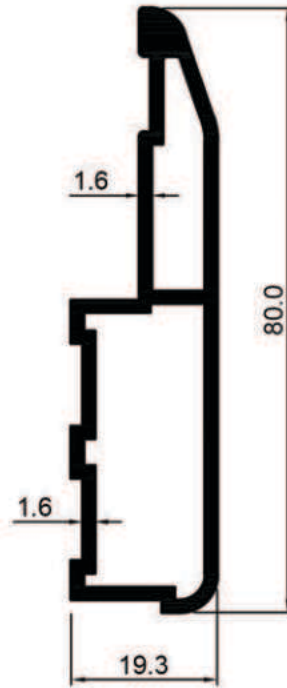

0781



0782

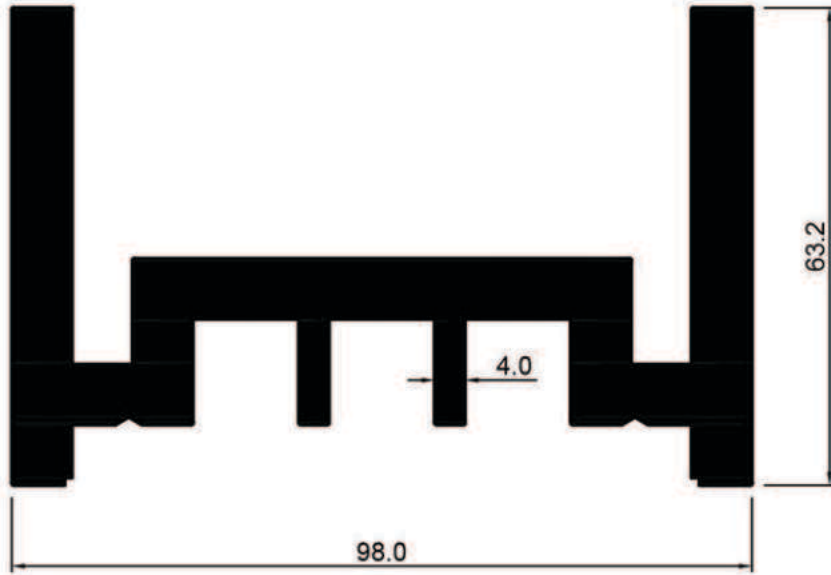

0783

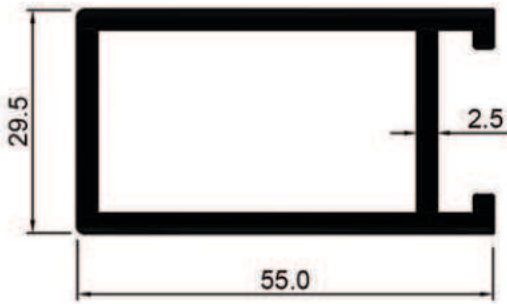

0784

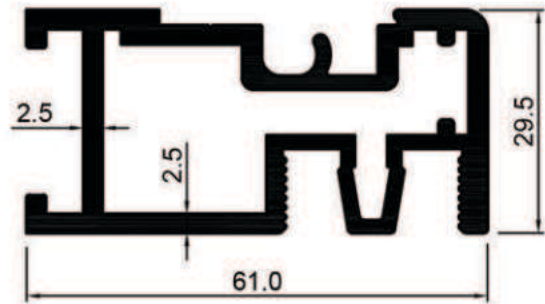

0785

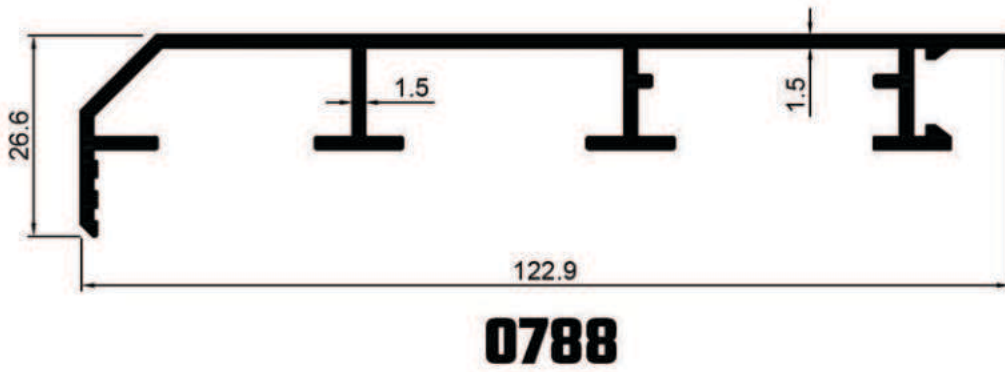
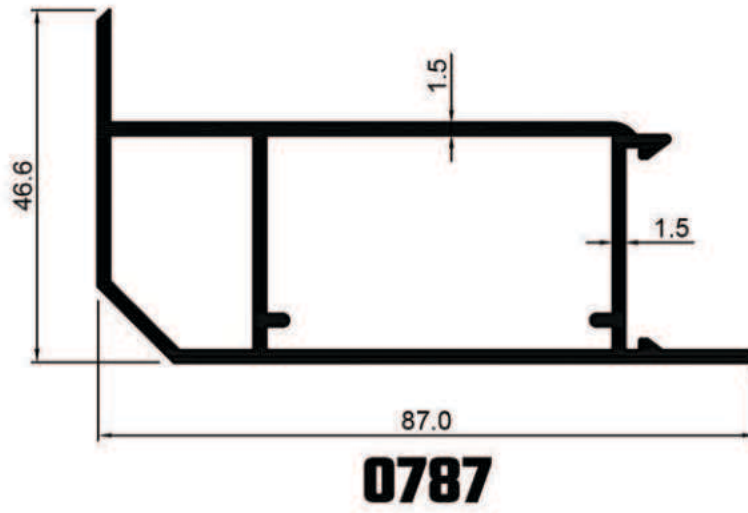
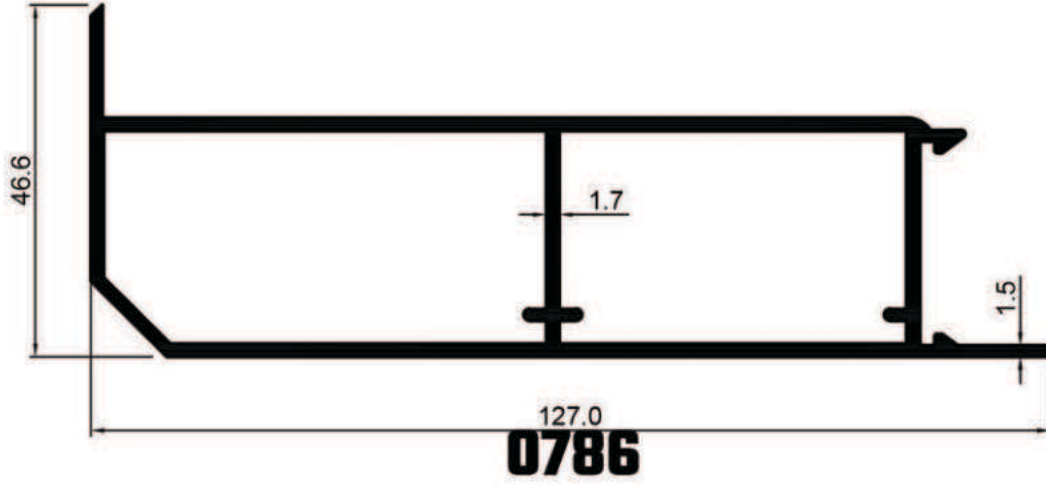

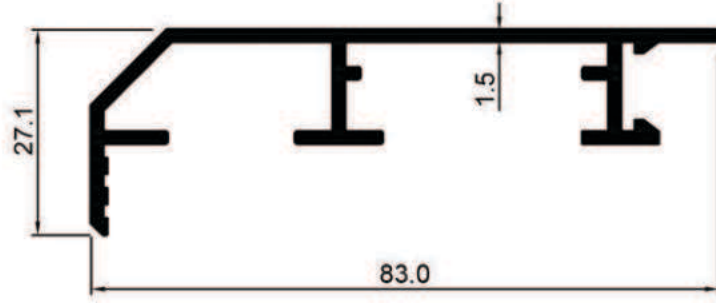

0789



MOBİLYA PROFİLLERİ

FURNITURE PROFILES

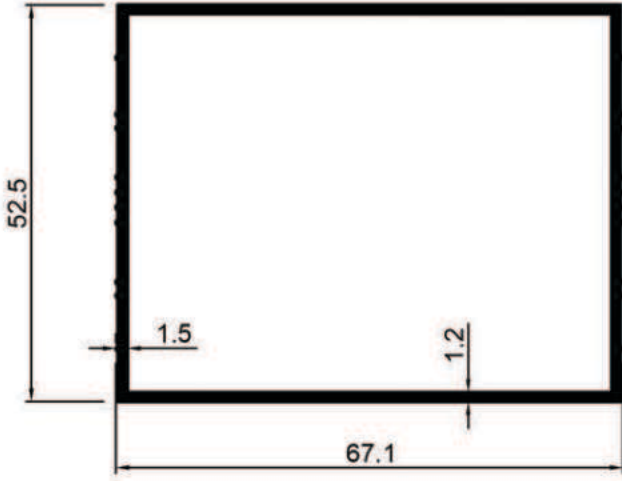

0852

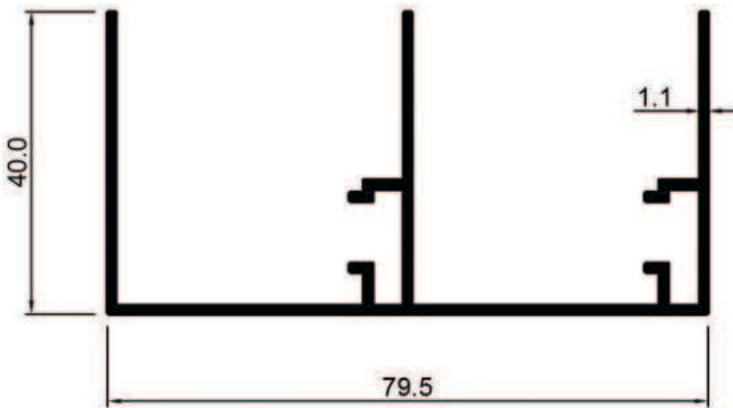

0854

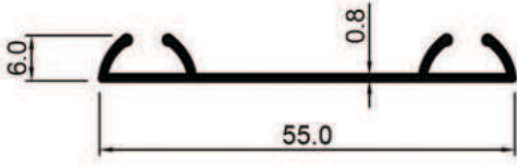

0856

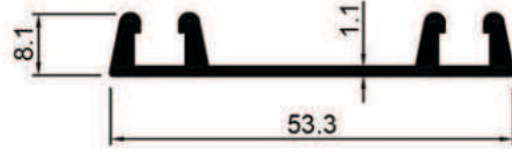

0857

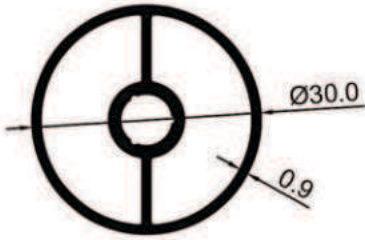

0858

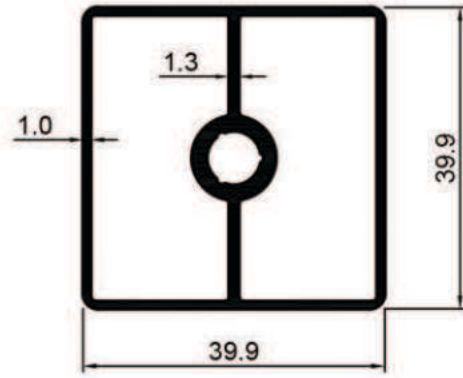

0859

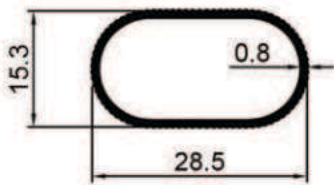

0860

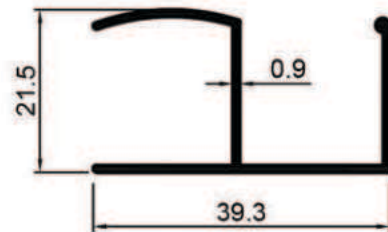

0861



MENFEZ PROFİLLERİ

CULVERT PROFILES

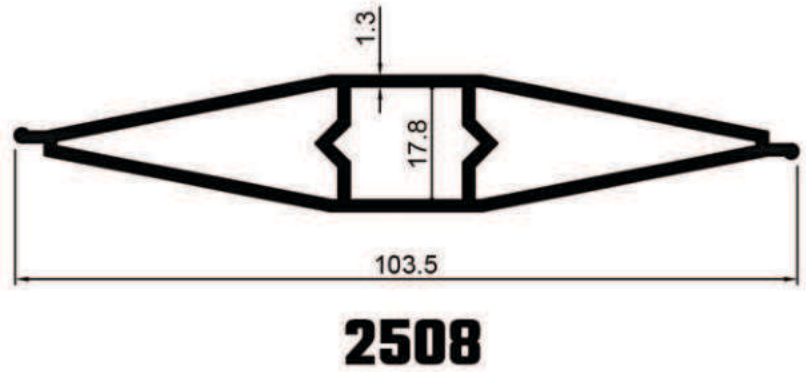
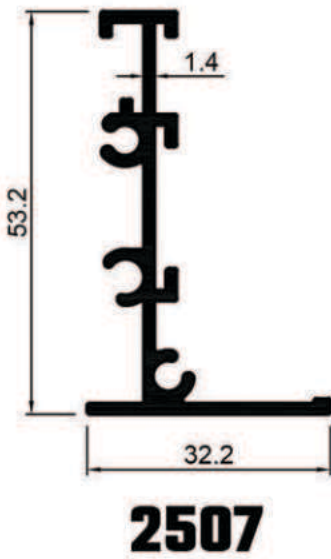
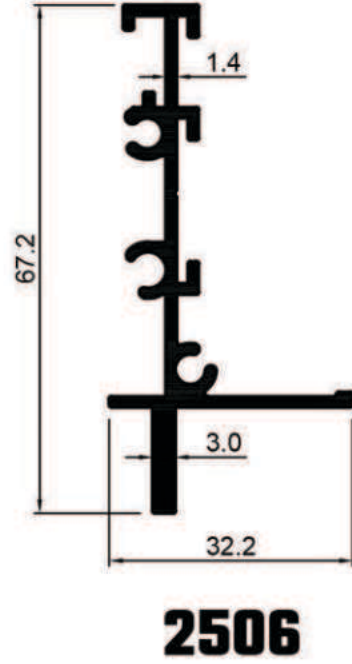
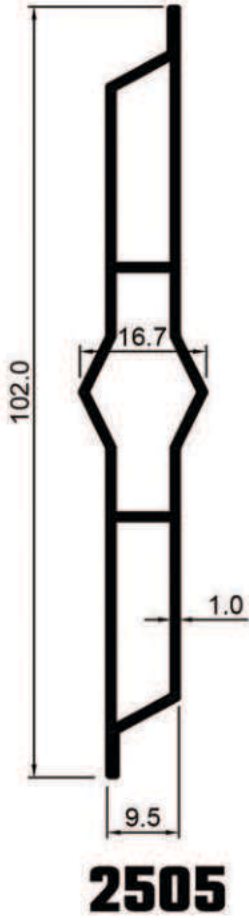

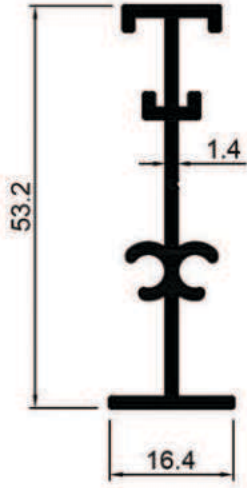

2509

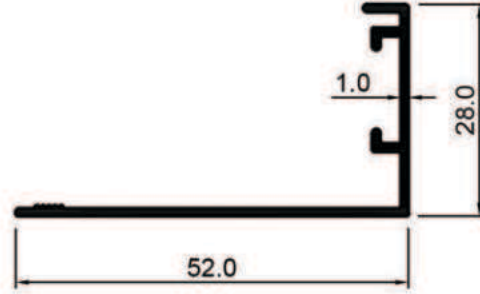

2510

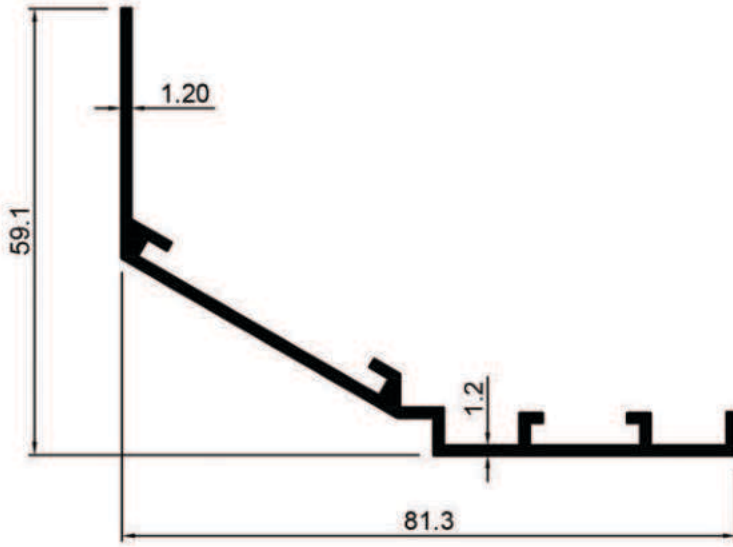

2511

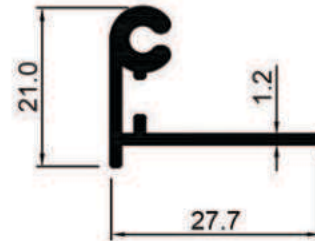

2512



2513

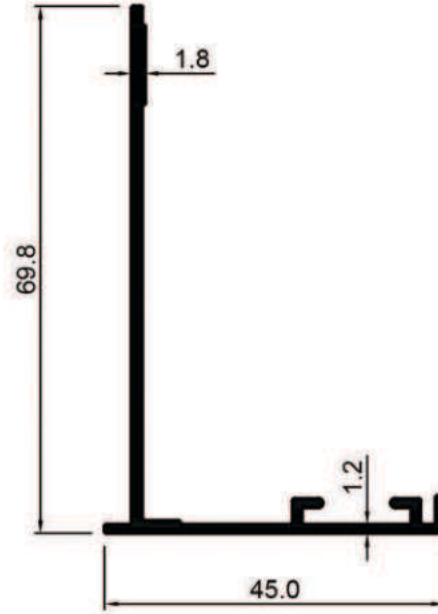

2514

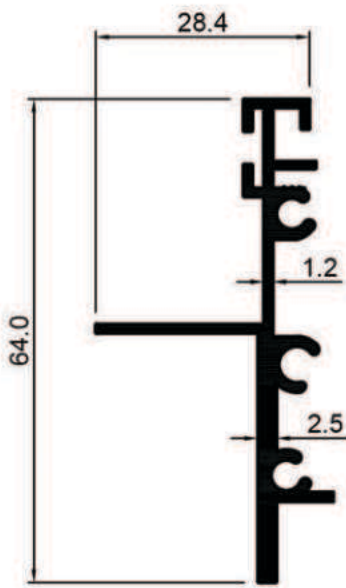

2515

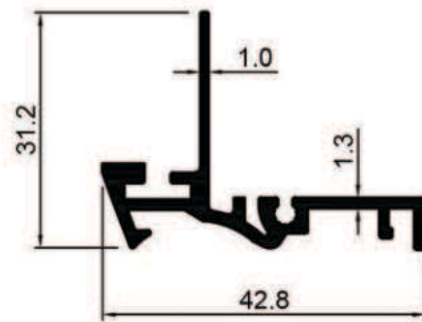

2516

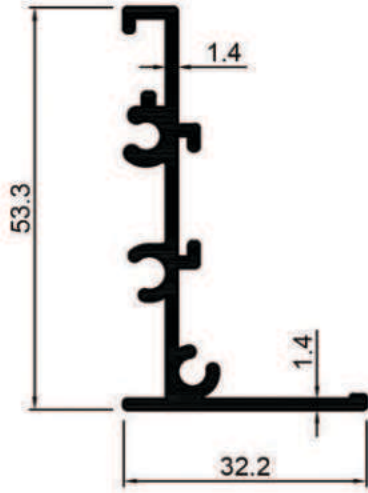

2517

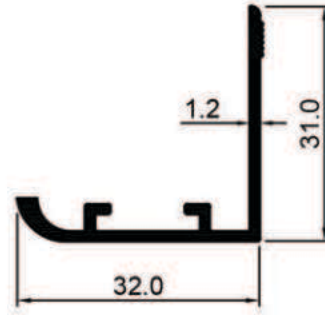

2520

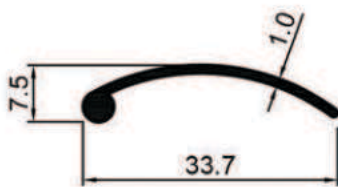

2519

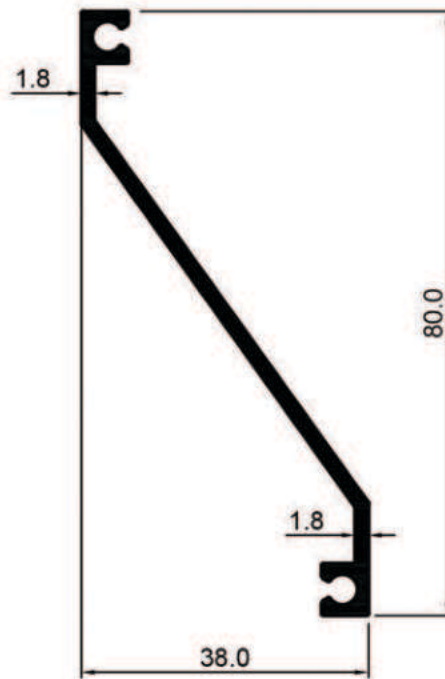

2521



RAF PROFİLLERİ

SHELF PROFILES

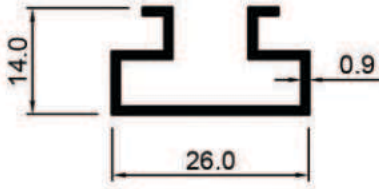

0301

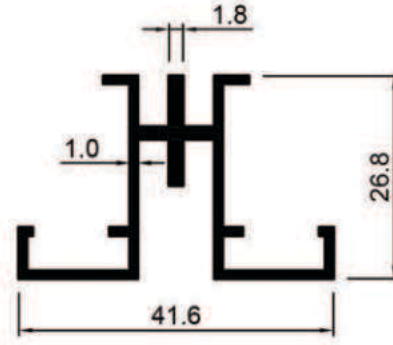

0303

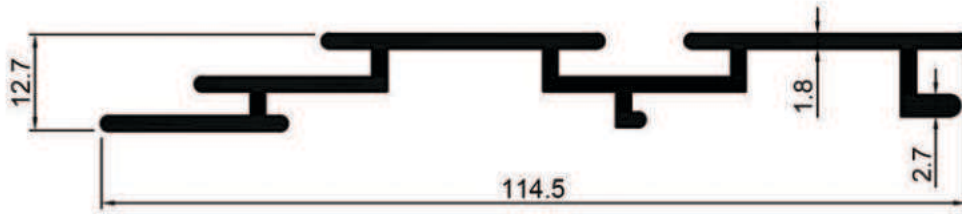

0302

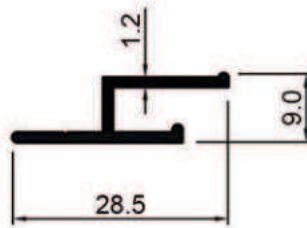

0304



DENİZLİK PROFİLLERİ

SILL PROFILES

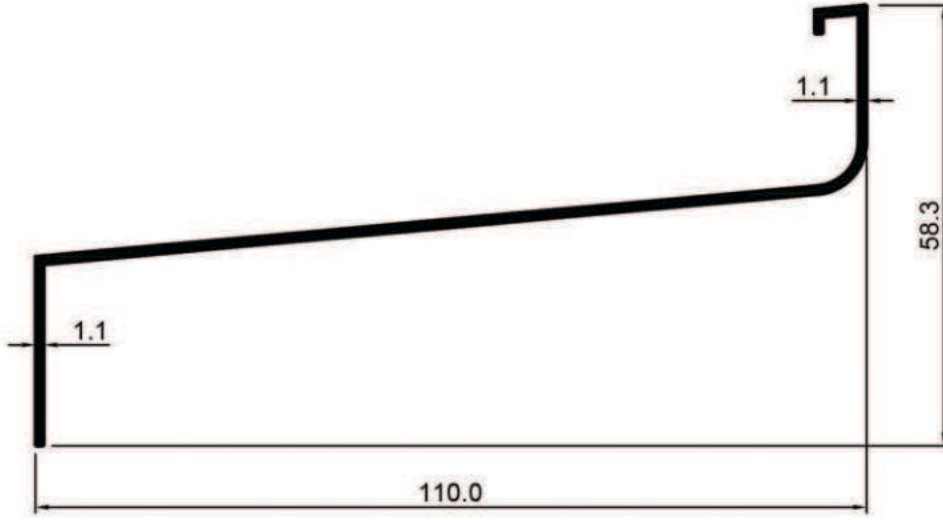

4101

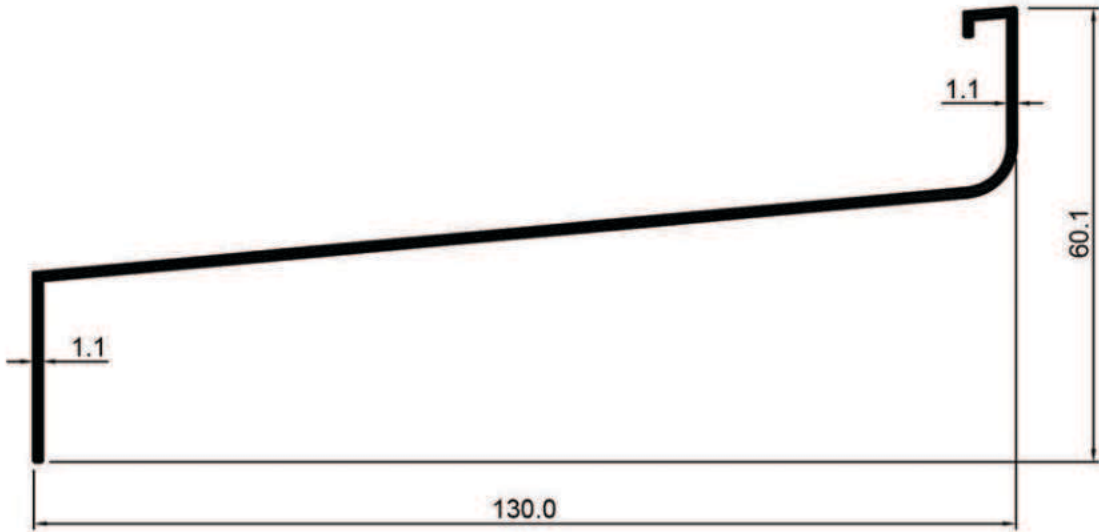

4102

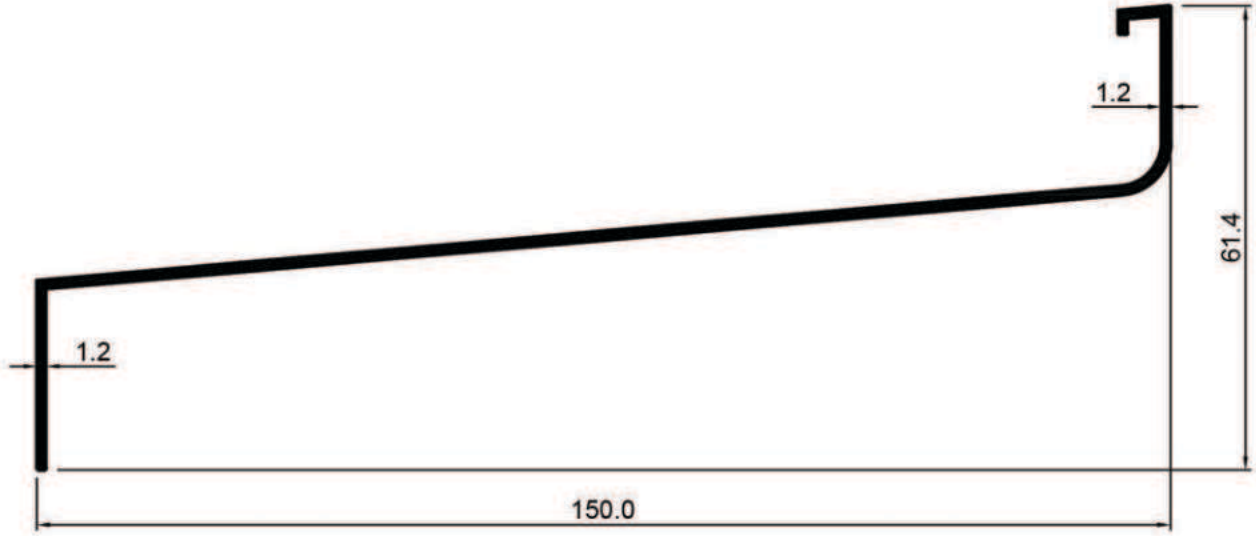

4103

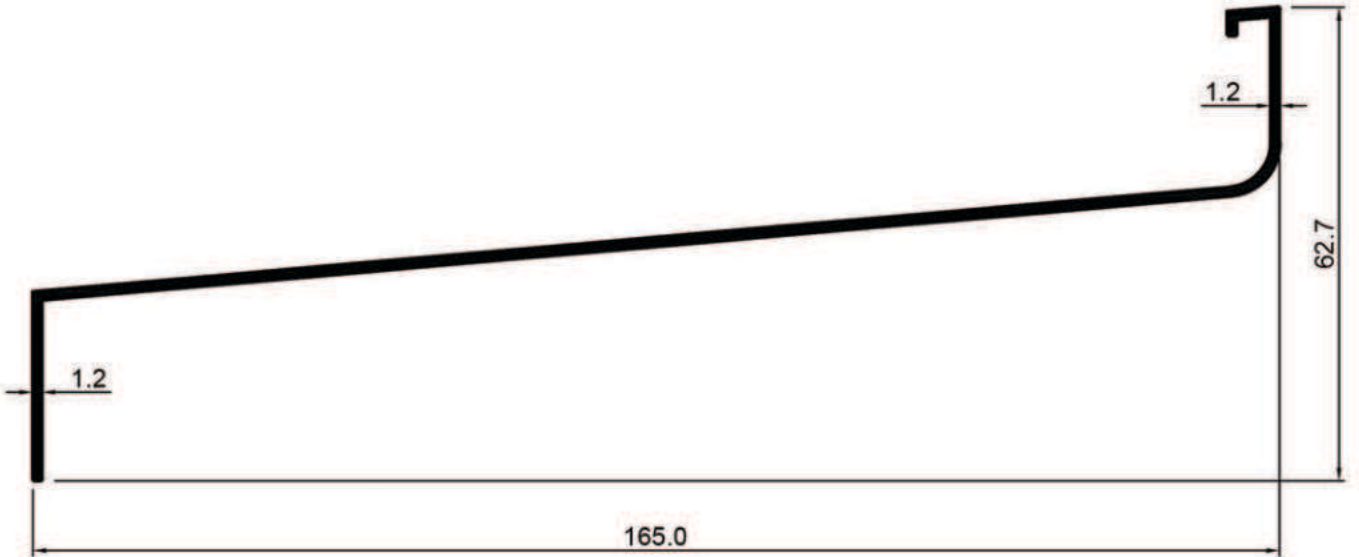

4104

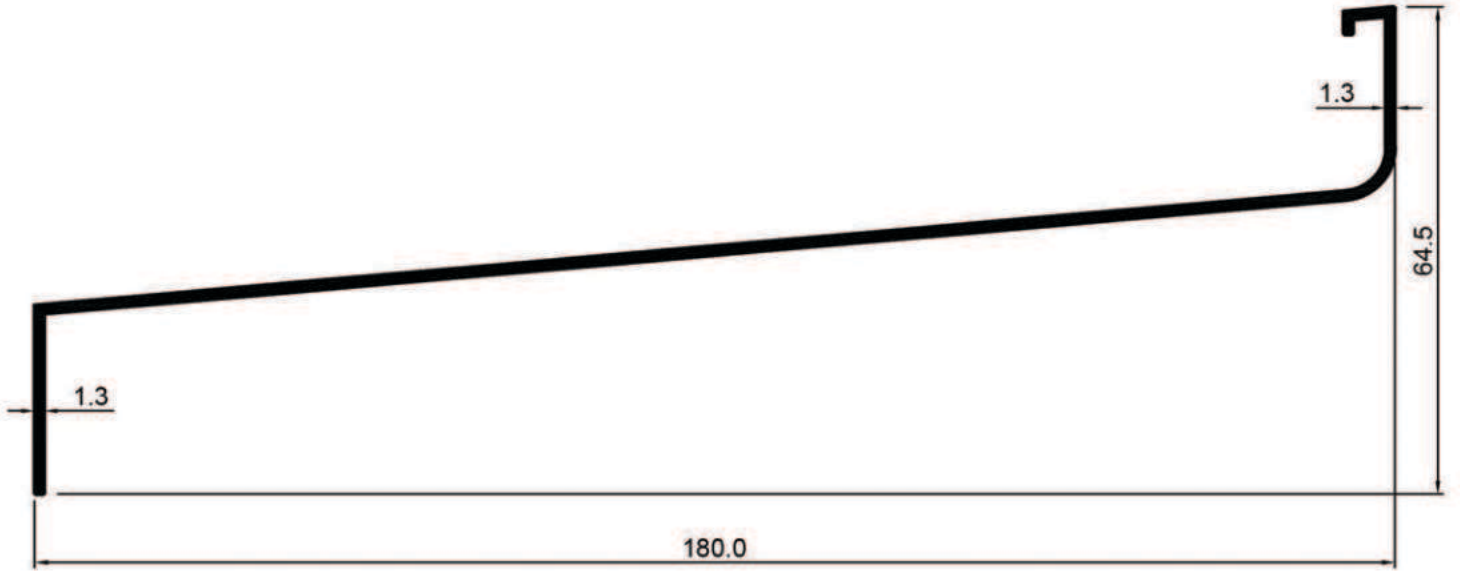

4105

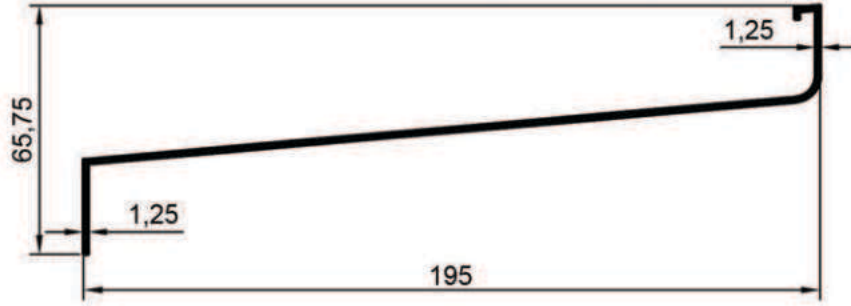

4106

ÖLÇEK 1/2

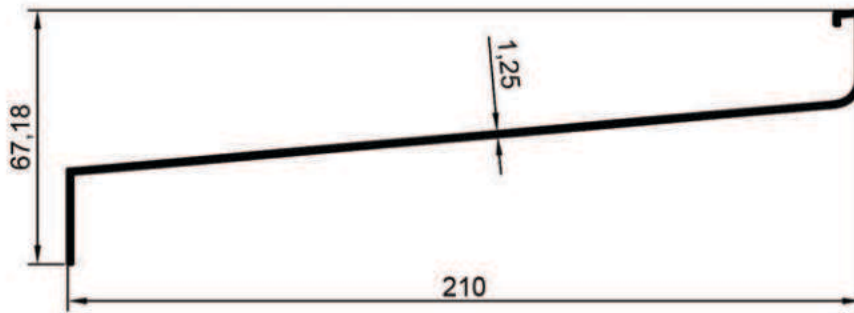

4107

ÖLÇEK 1/2

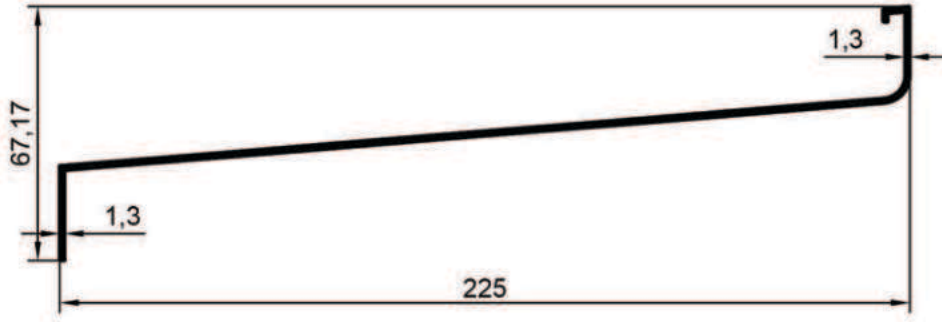

4108

ÖLÇEK 1/2

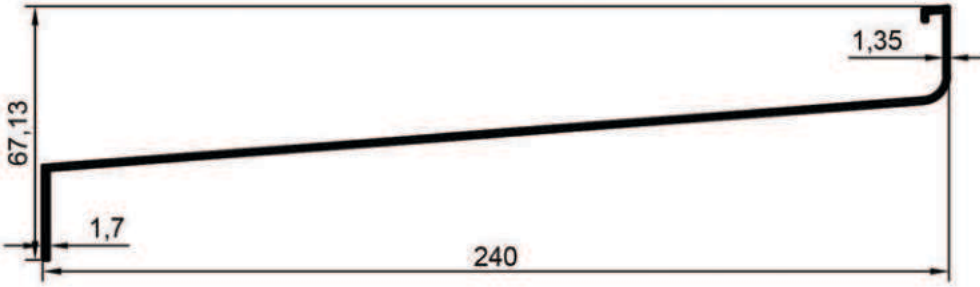

4109

ÖLÇEK 1/2

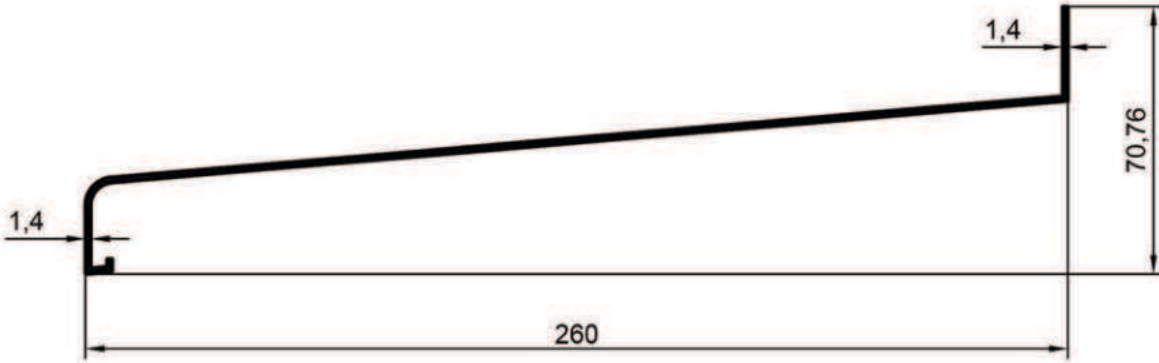

4110

ÖLÇEK 1/2



DİLATASYON PROFİLLERİ

DILATATION PROFILES

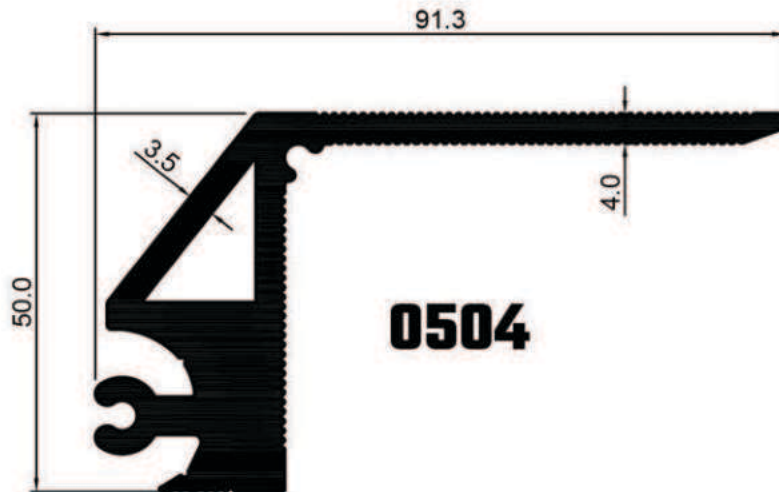
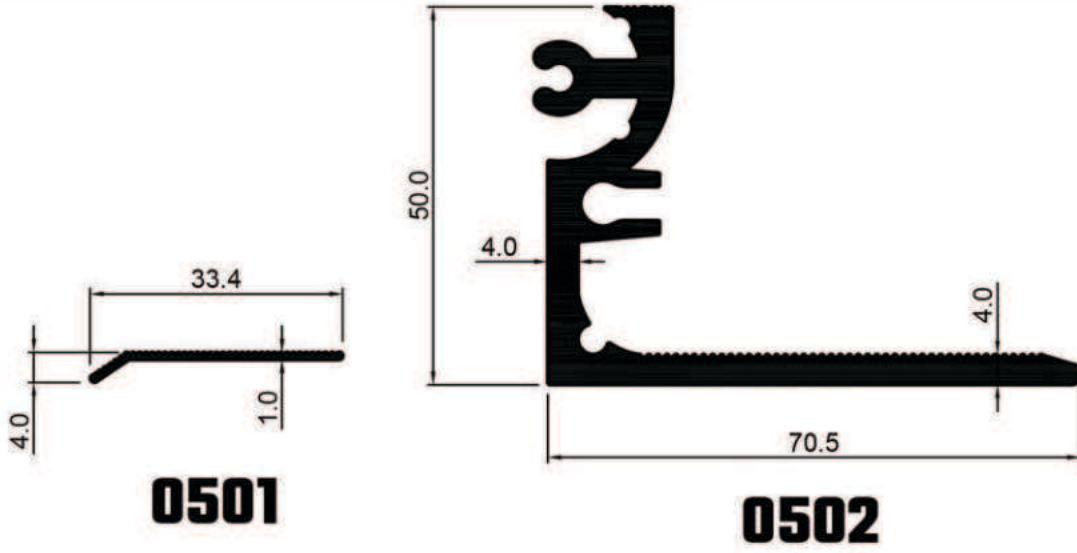

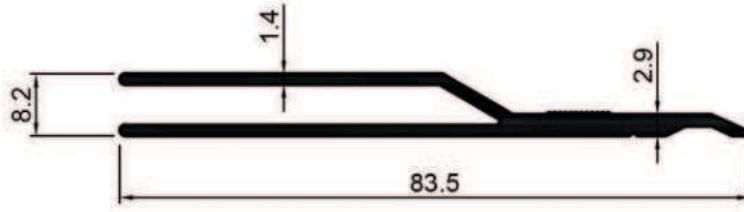

0505

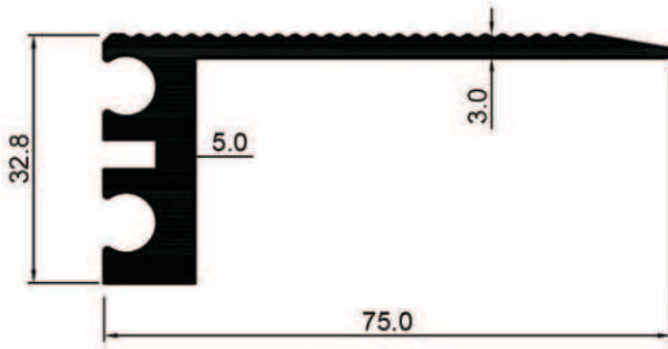

0509

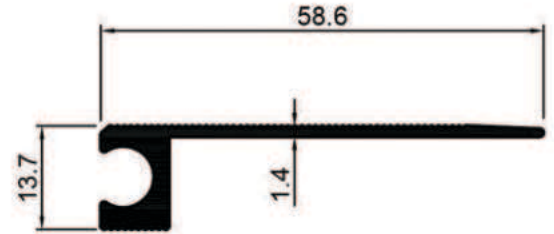

0510

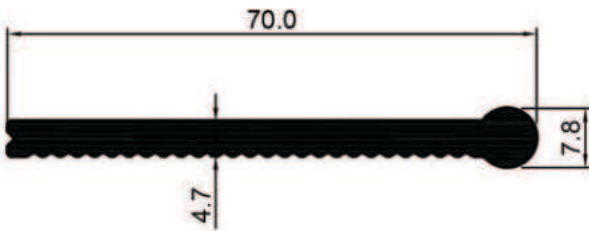

0511

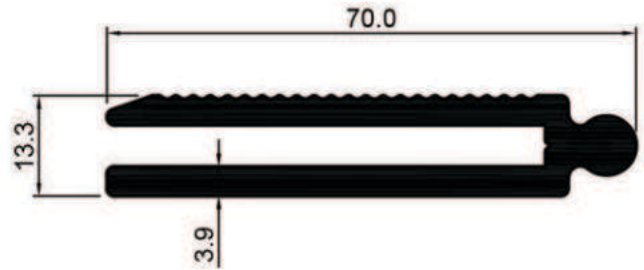

0512

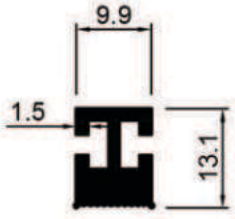

0513



0514

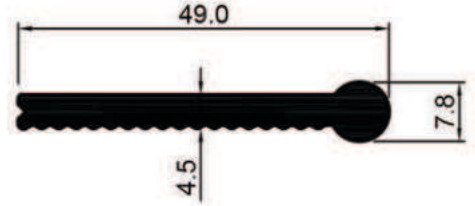

0515



0516



0517



0518

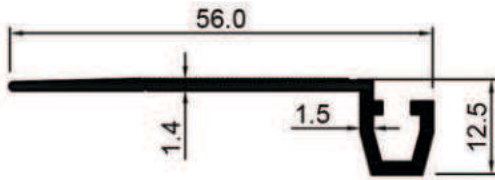

0520

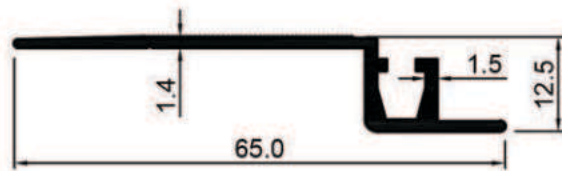

0521

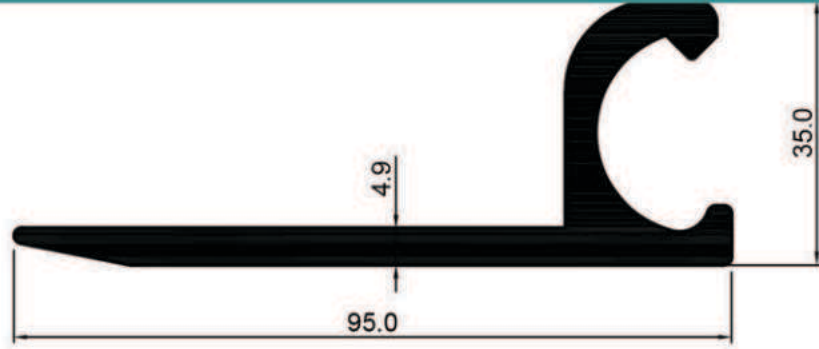

0524

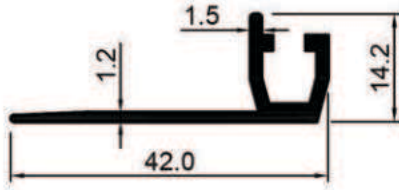

0525

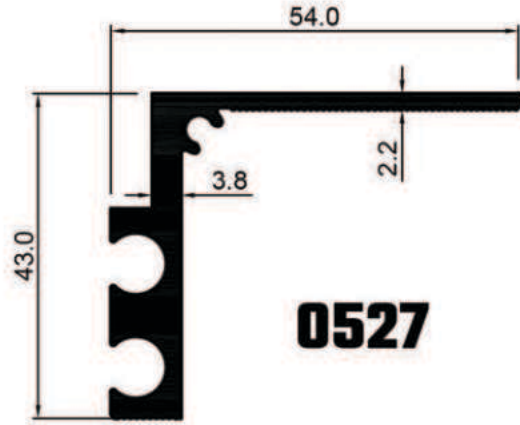

0527

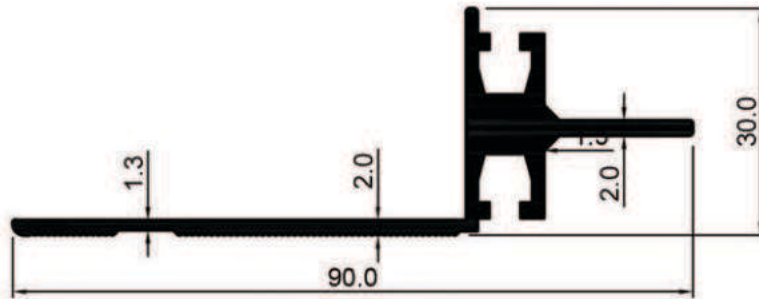

0528

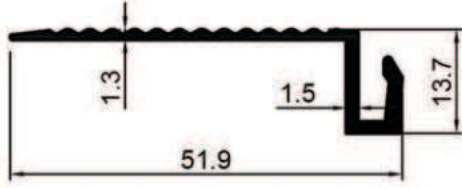

0529

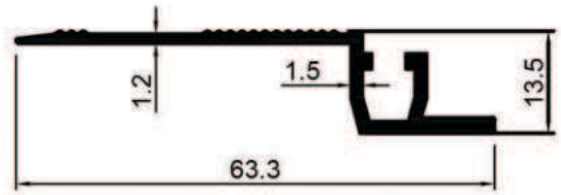

0530

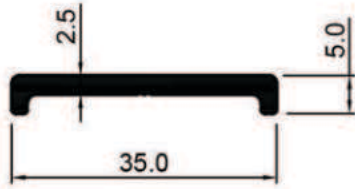

0534

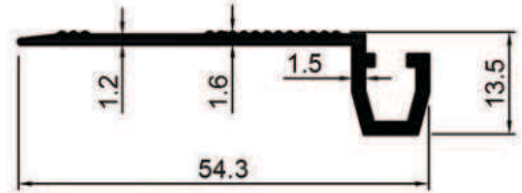

0531

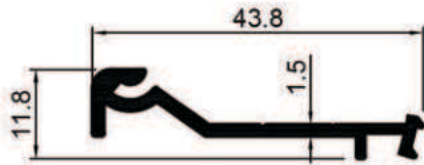

0535

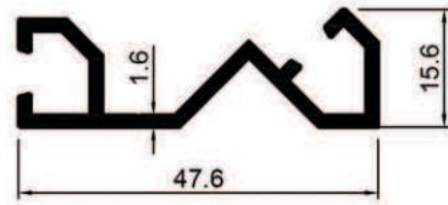

0536

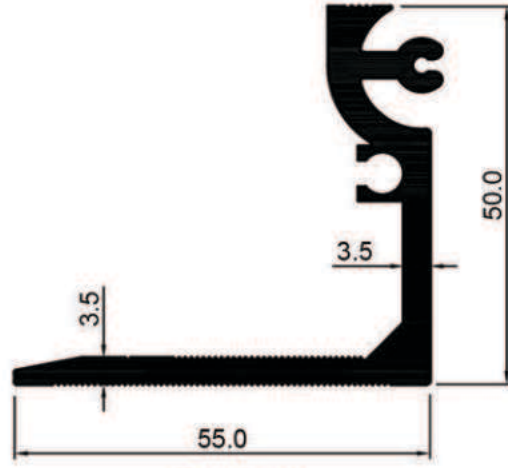

0537

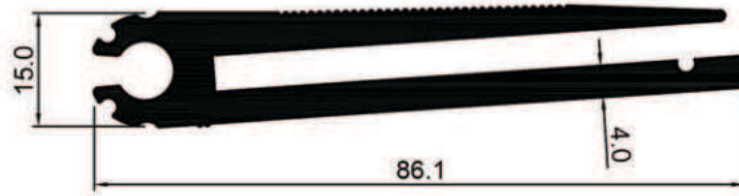

0538

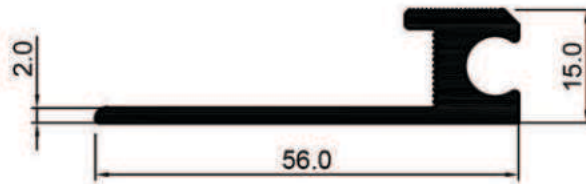

0539

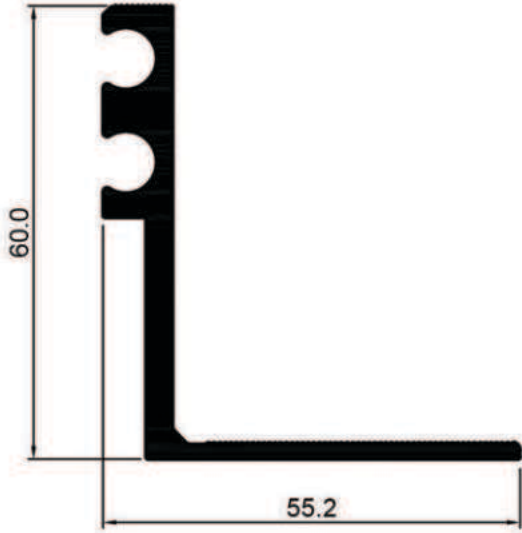

0549

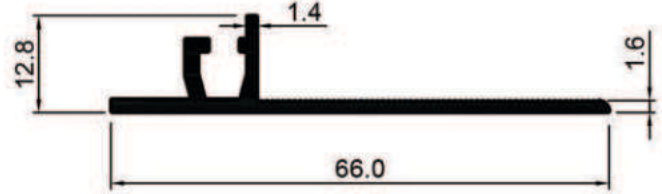

0550

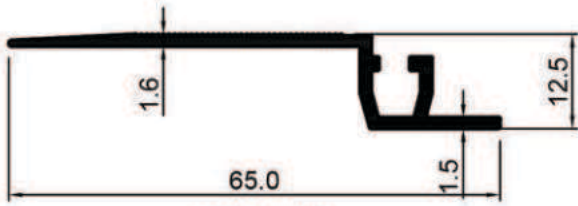

0551

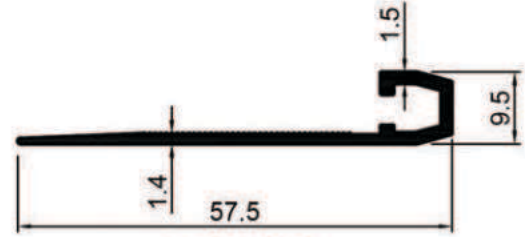

0552

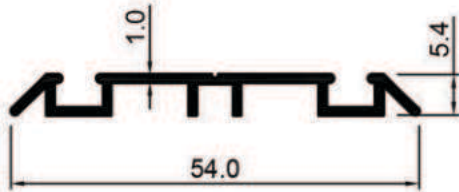

0554

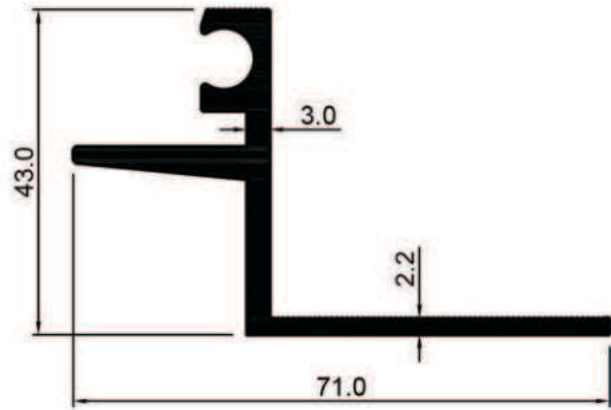

0557

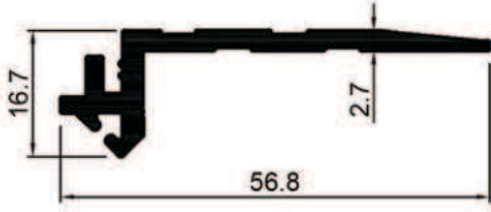

0558



0559

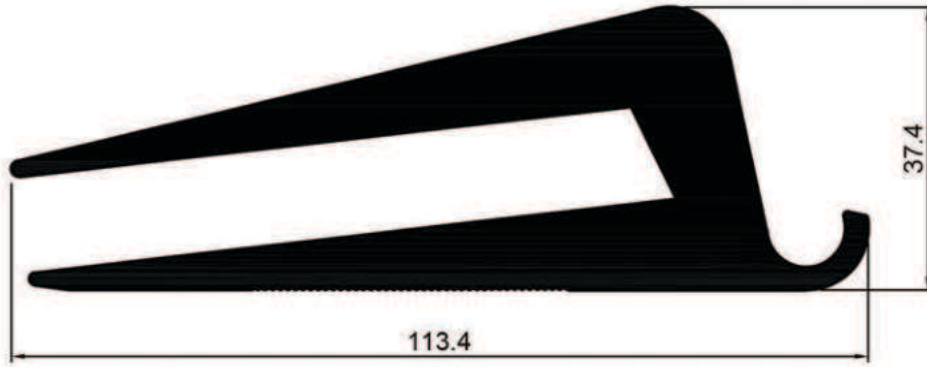

0561

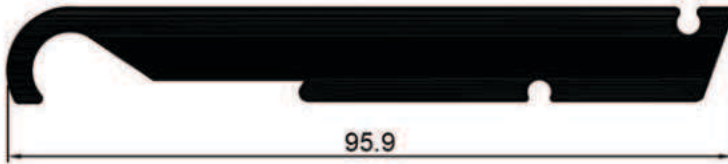

0562

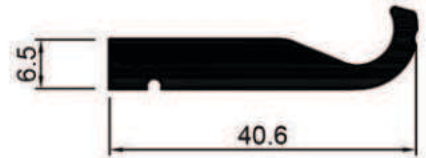

0560

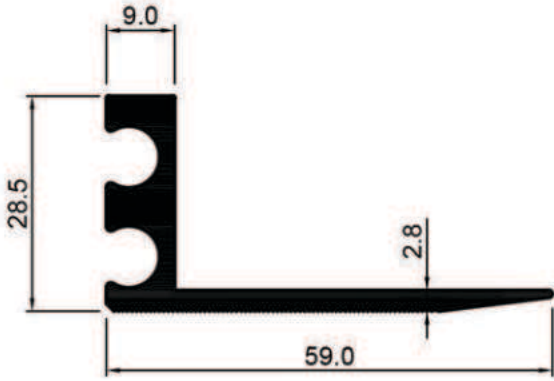

0563

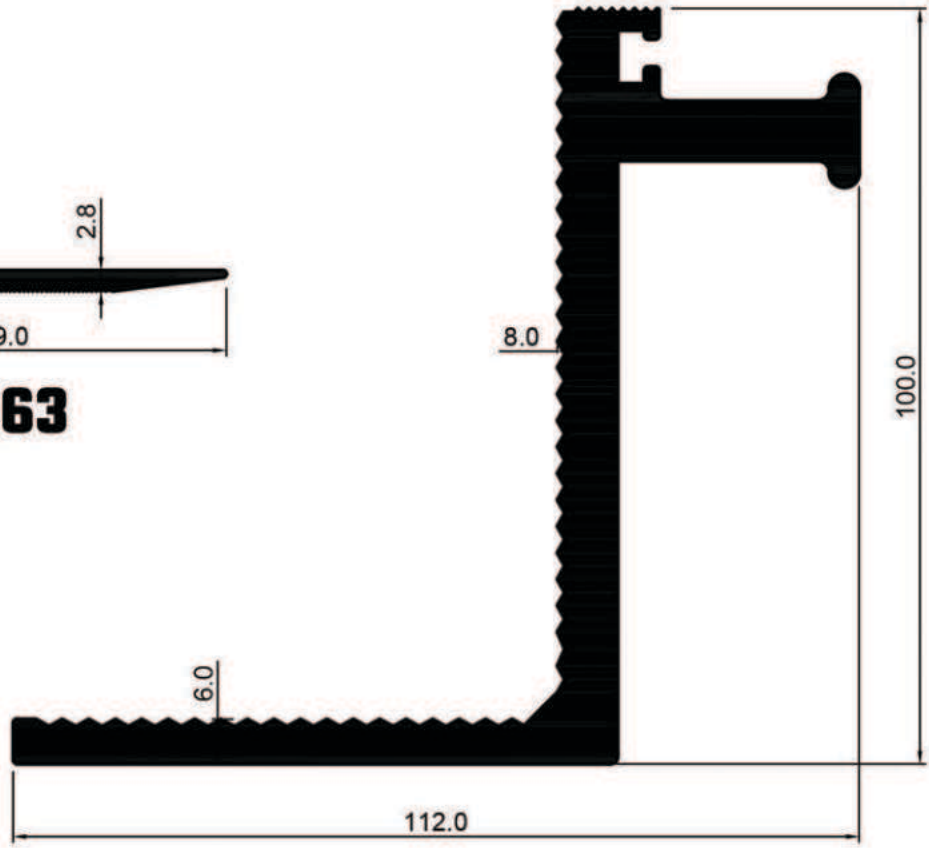

0564

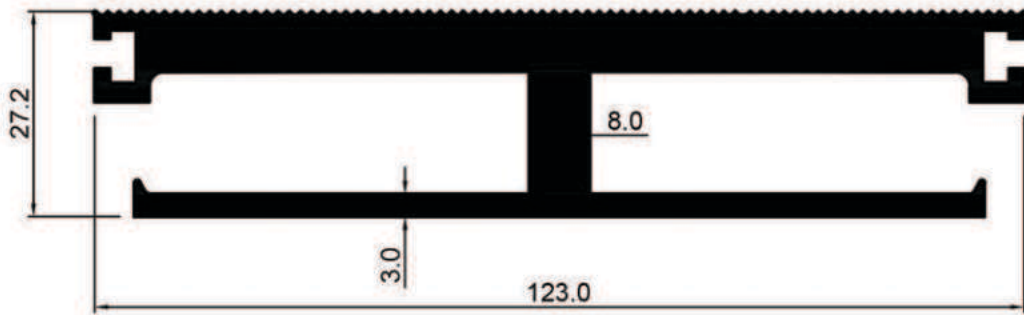

0565

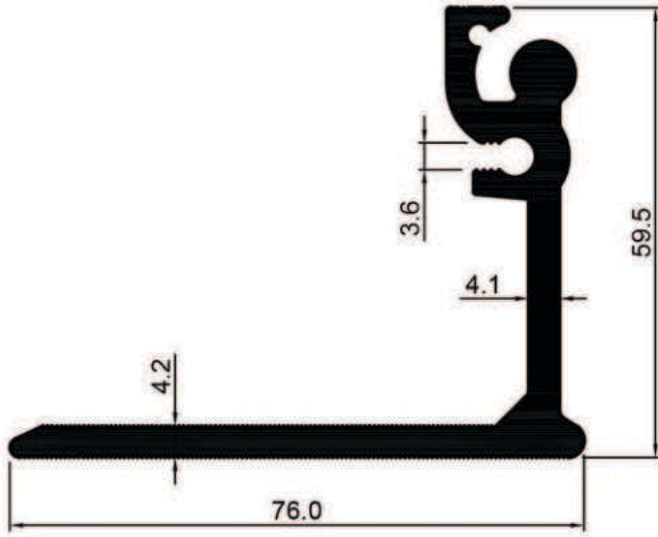

0566

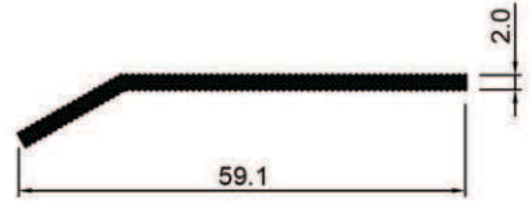

0567

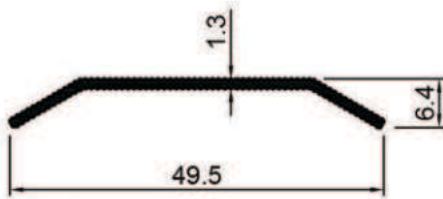

0568

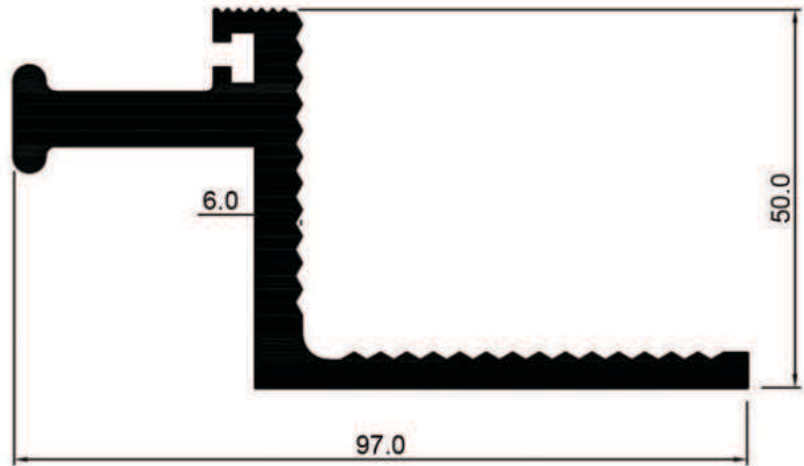

0569

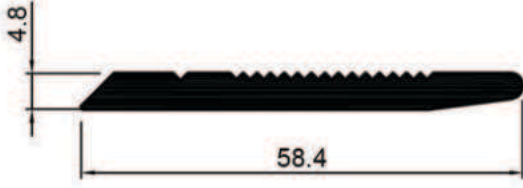

0570

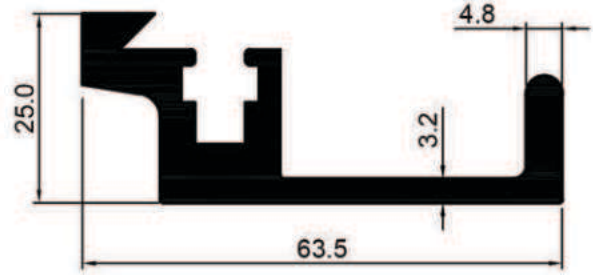

0571

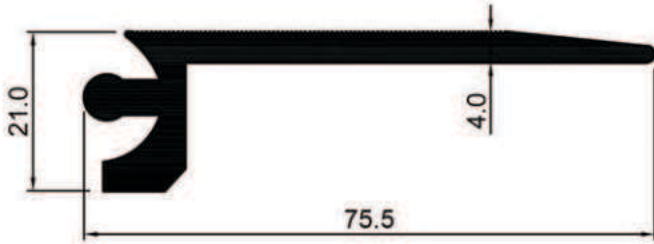

0572

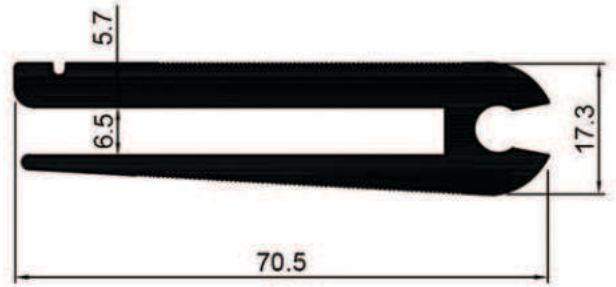

0573



0574



0575

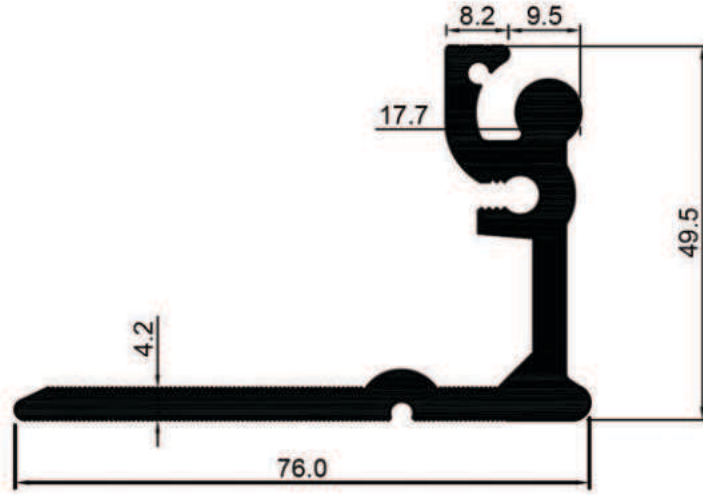

0576



0577

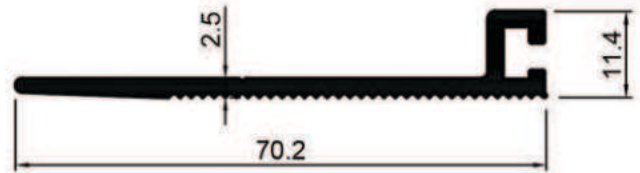

0578



0579

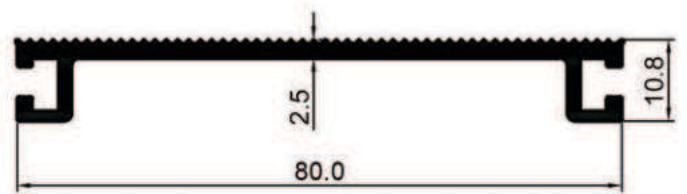

0580



0581

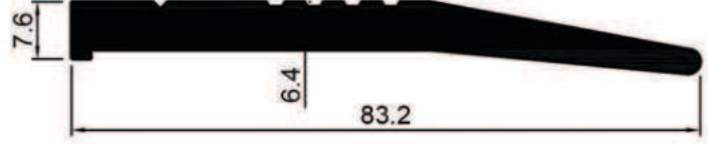

0582

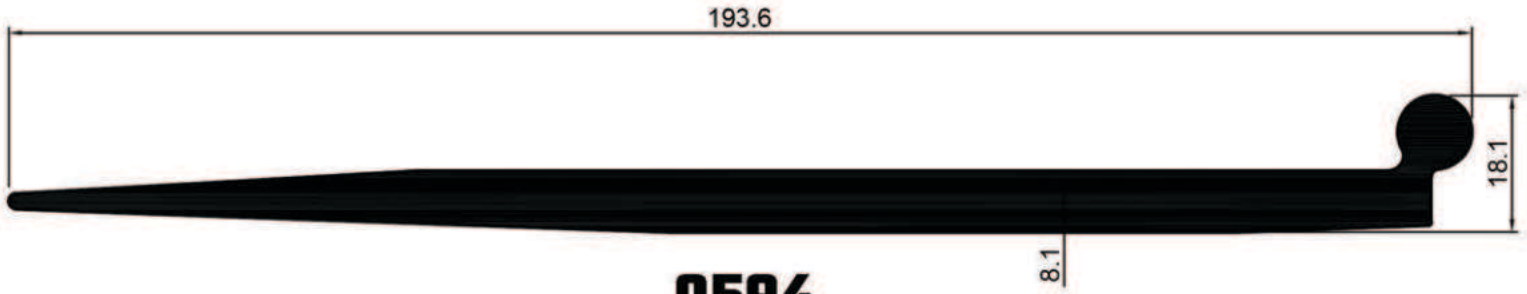

0594

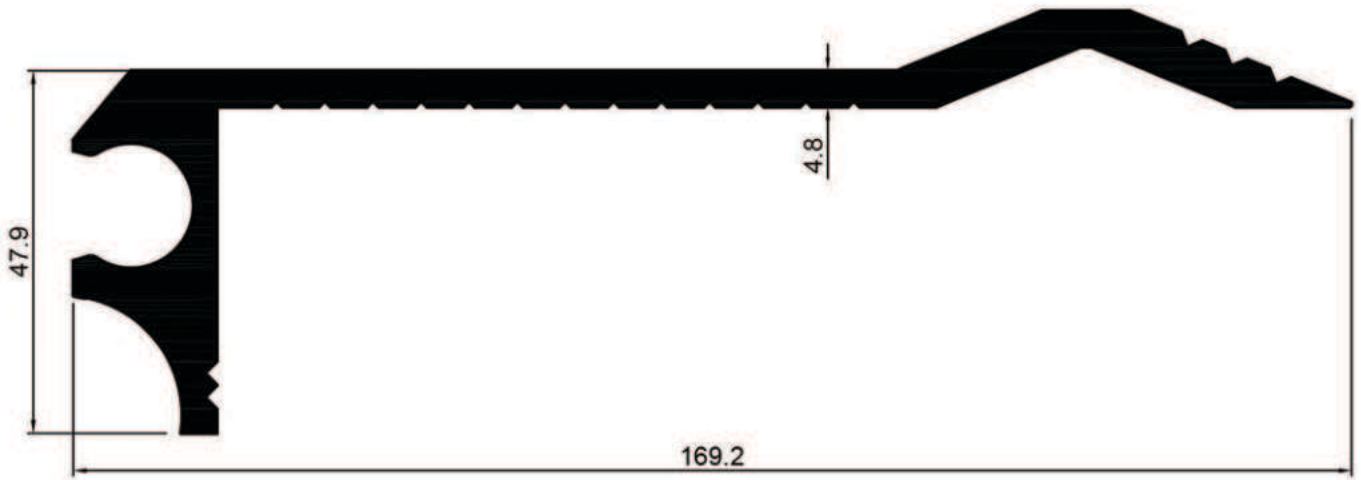

0584

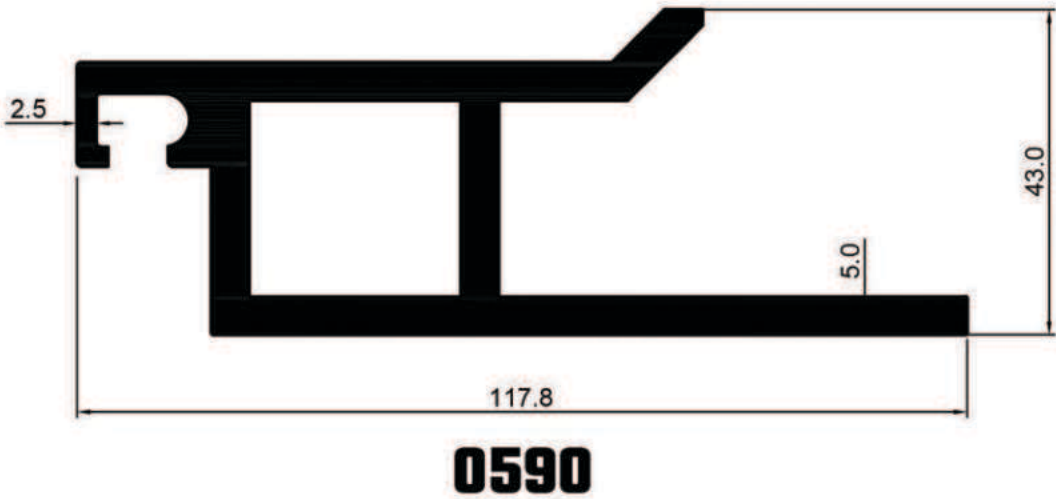
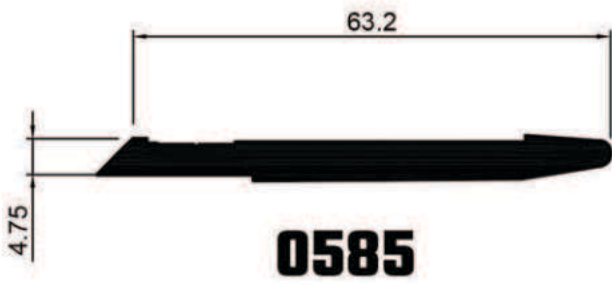

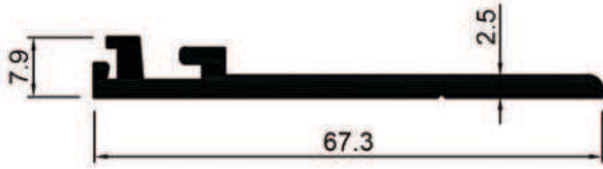

0591

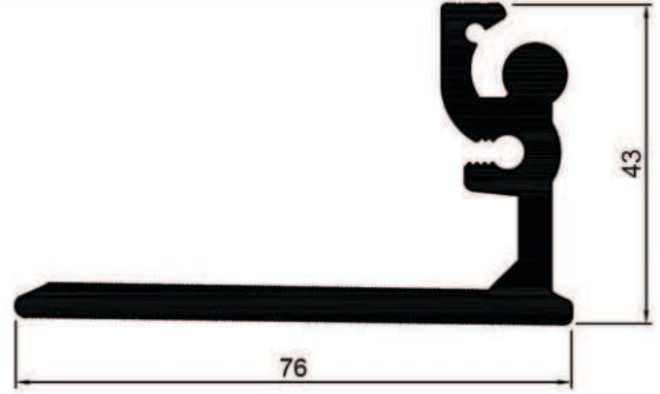

0593

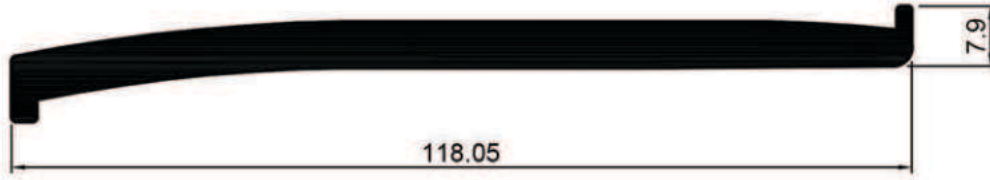

0592

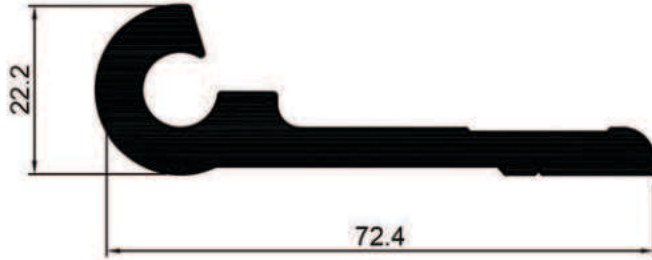

0595

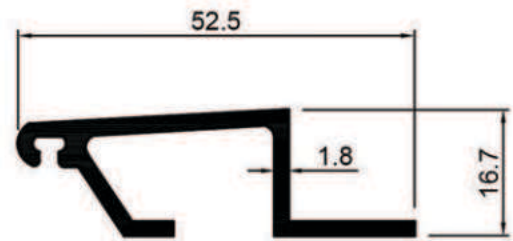

0596

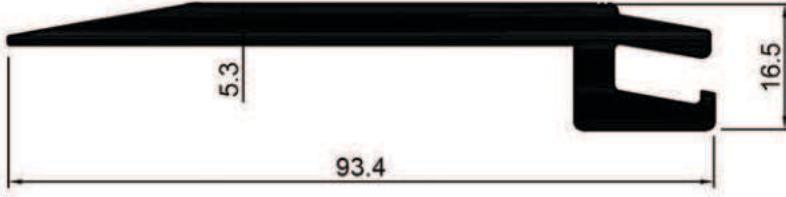

0598

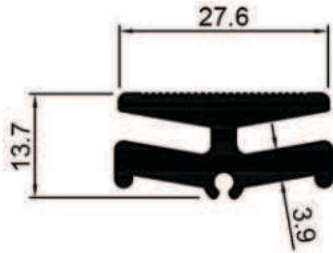

0599

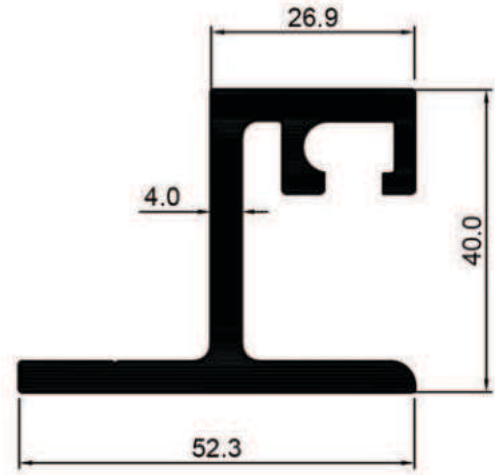

0597

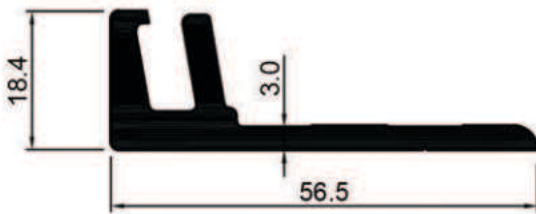

0600

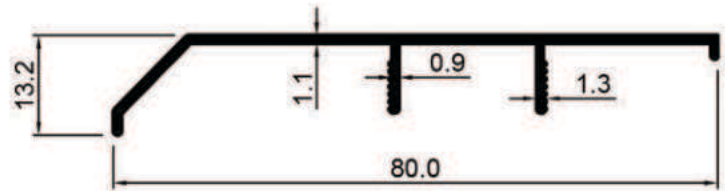

0601

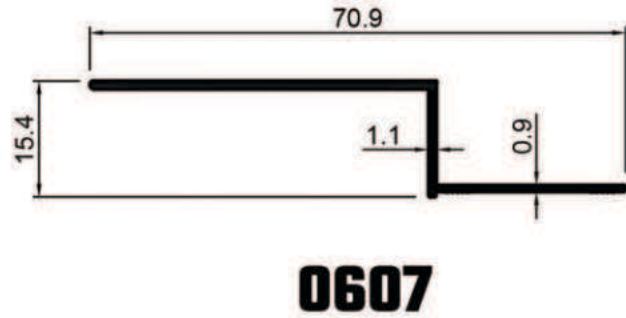
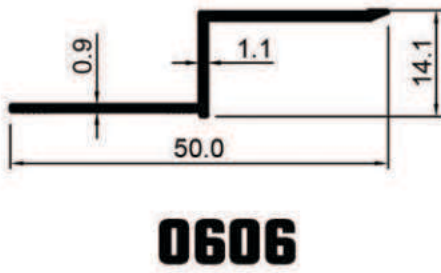
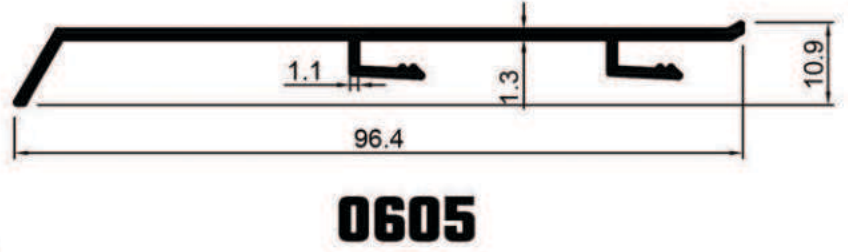
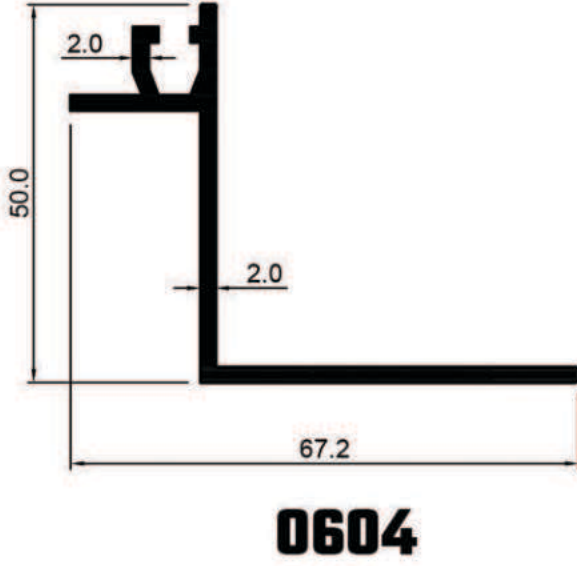
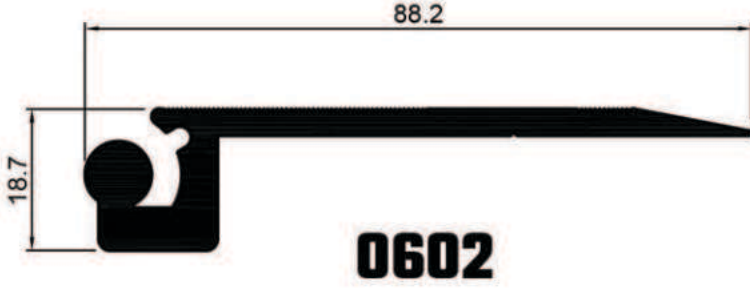

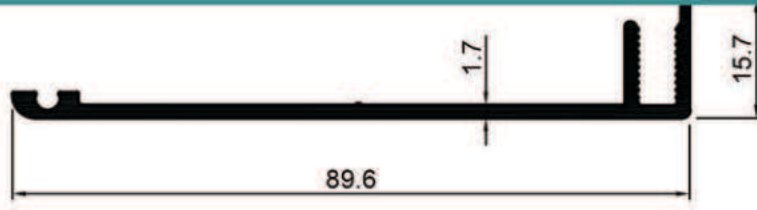

0608

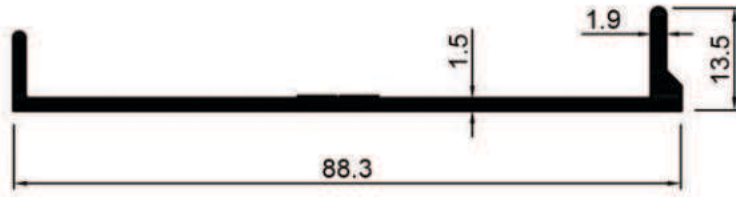

0610

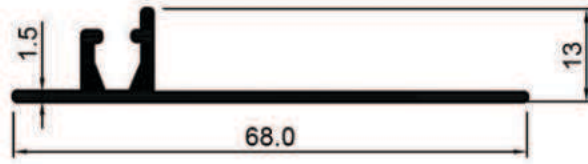

0615

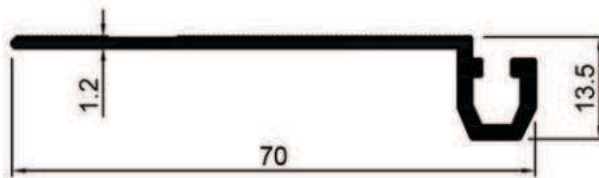

0616

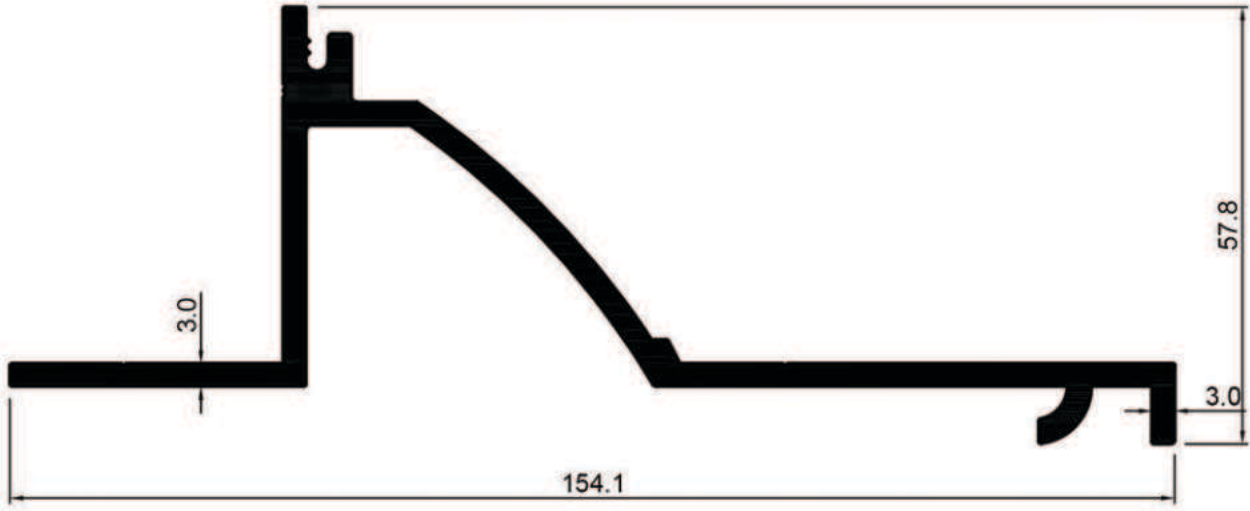

0612

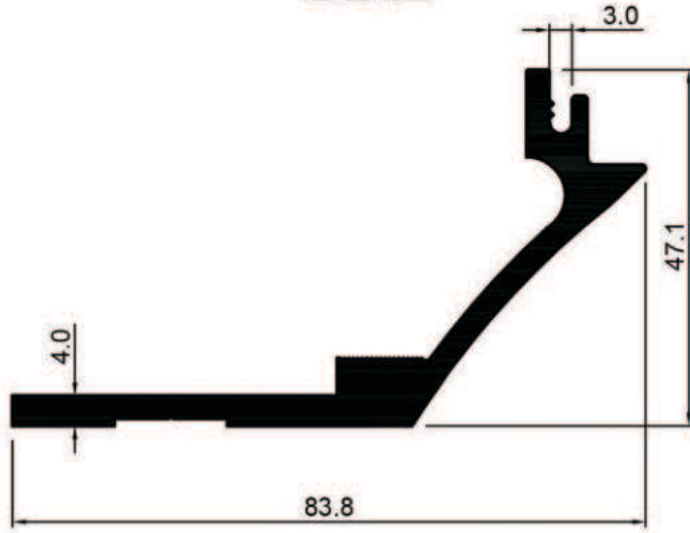

0613

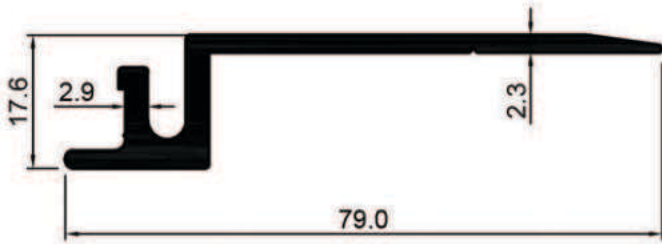

2962

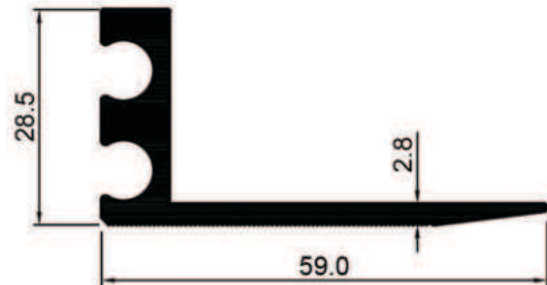

2983

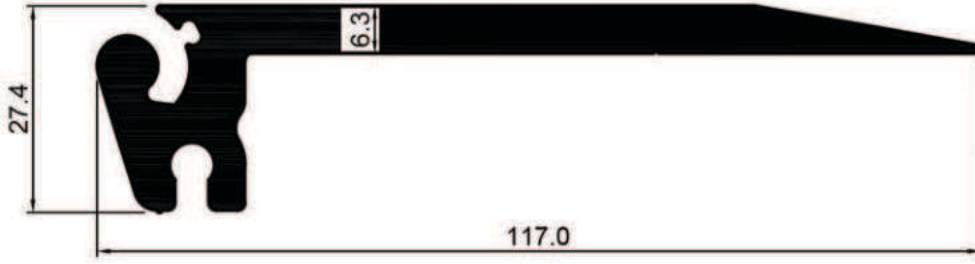

0619

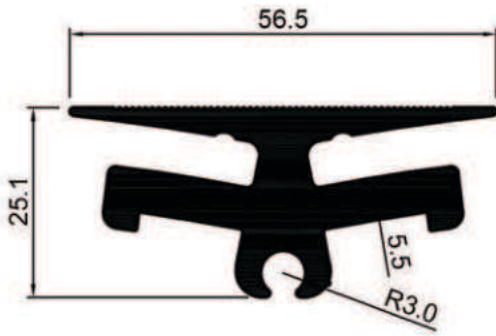

0620

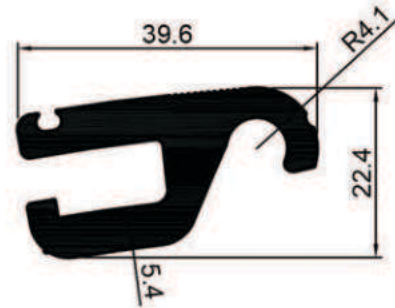

0621

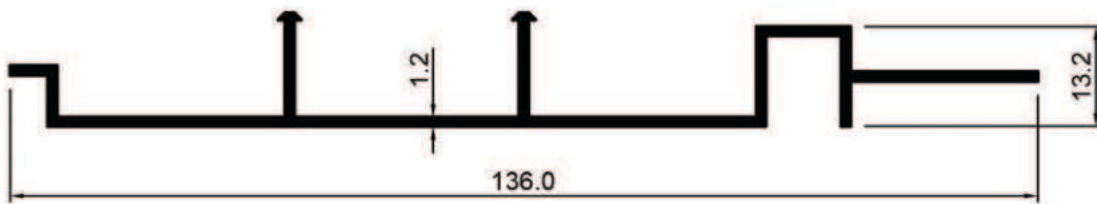

0623

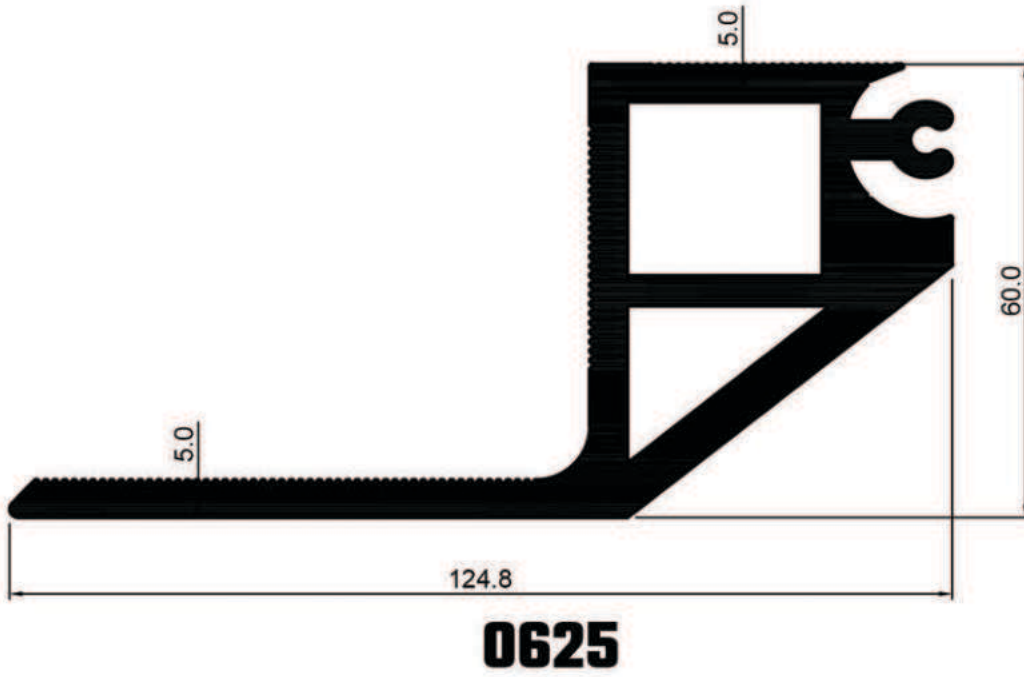
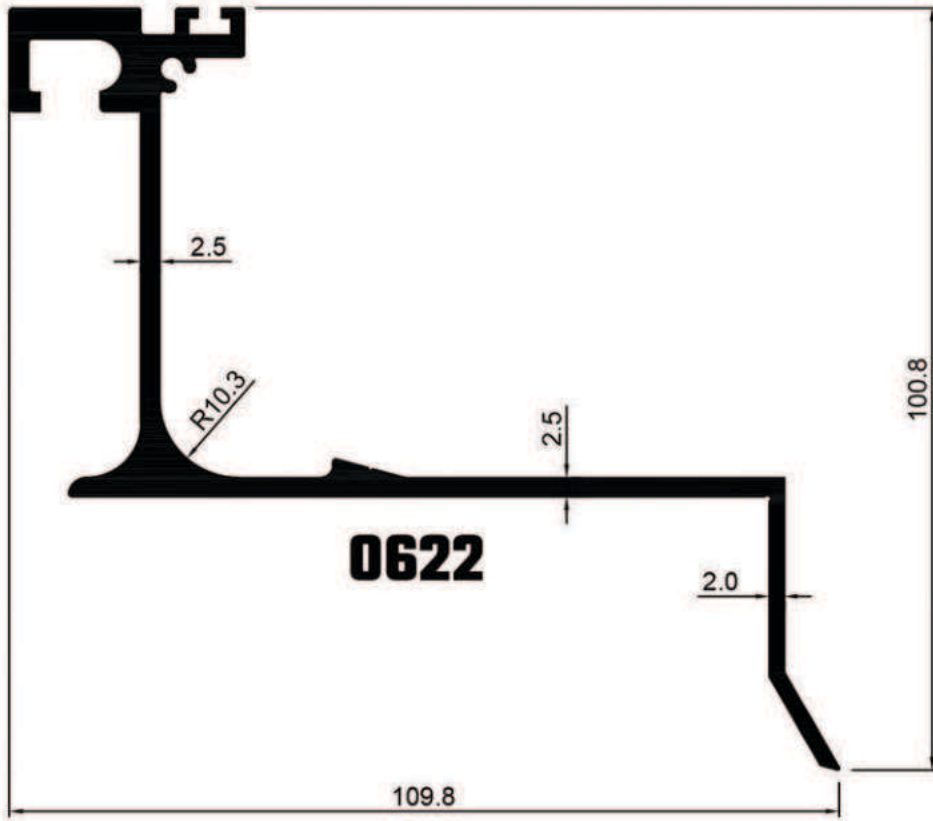

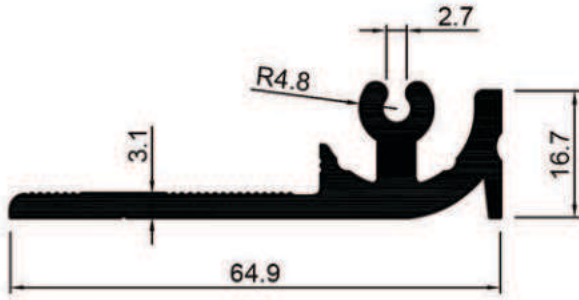

0626

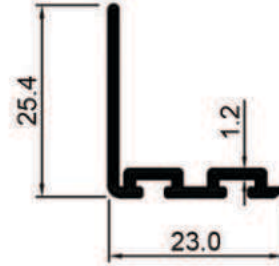

0628

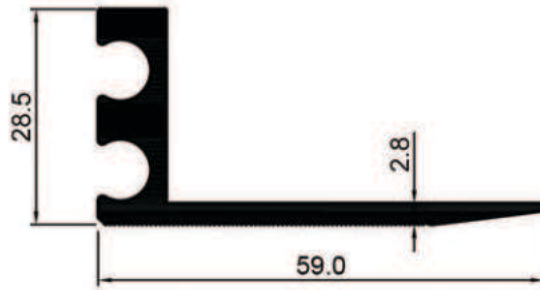

2983

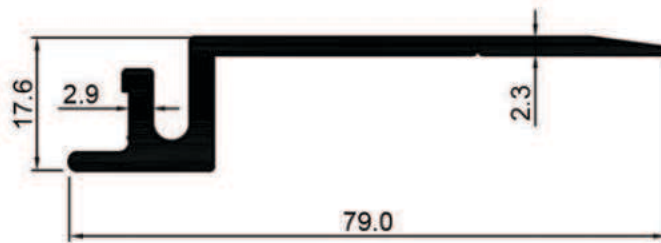

2962

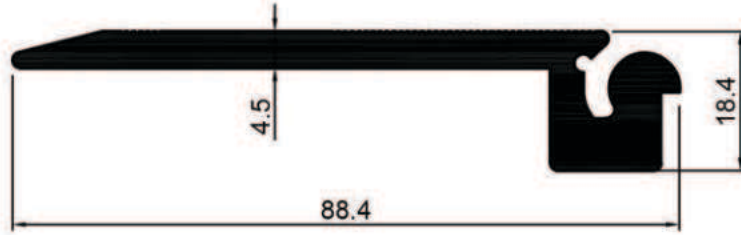

4622



4664

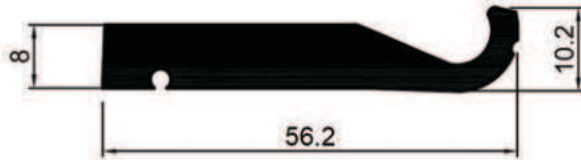

4665

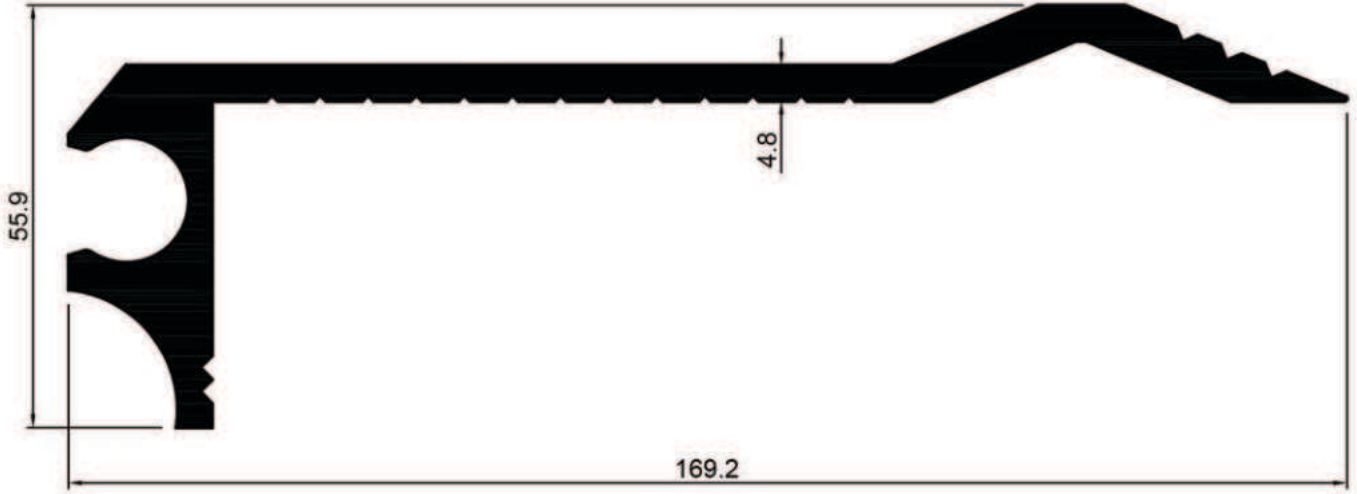

0638

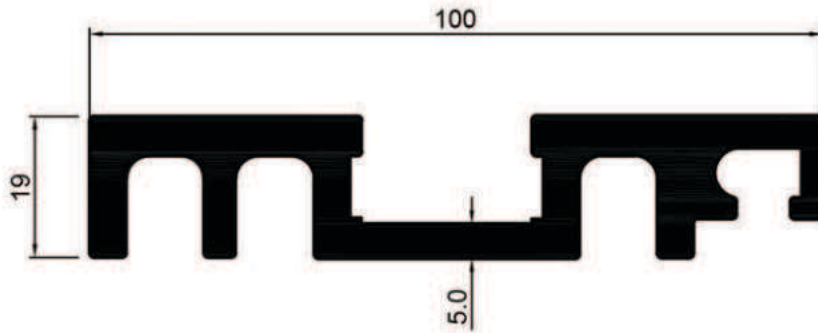

2631

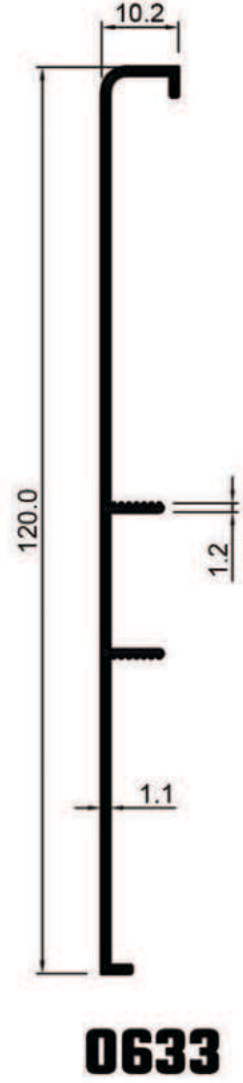
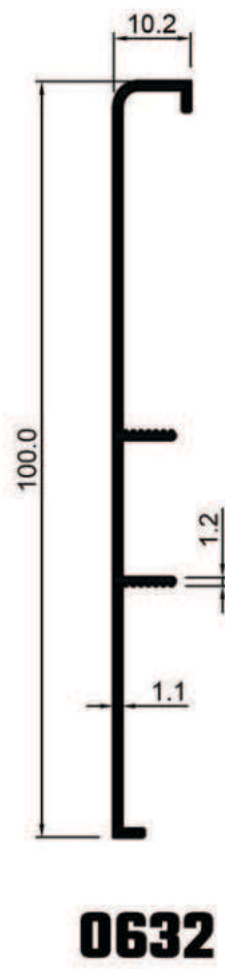
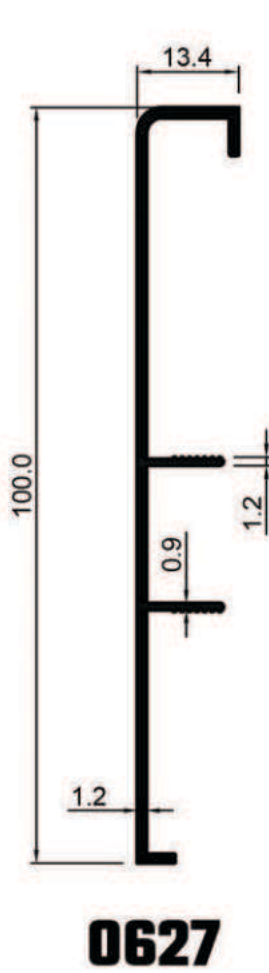

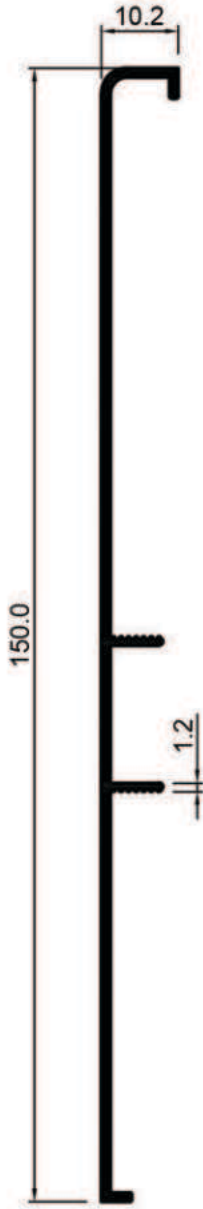

0634

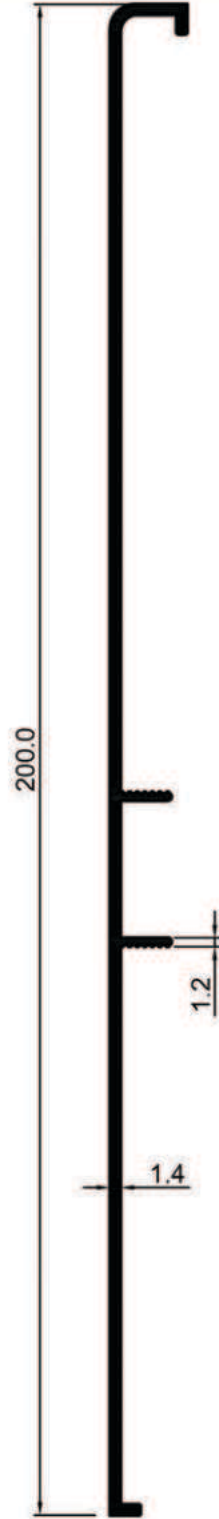

0636

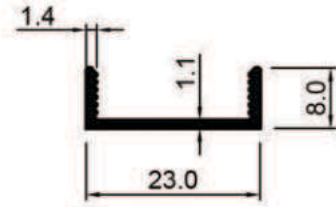

0635

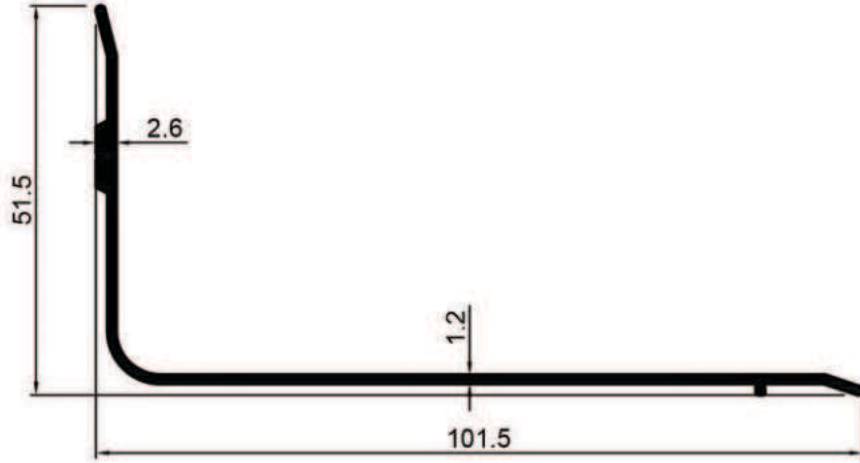

0541

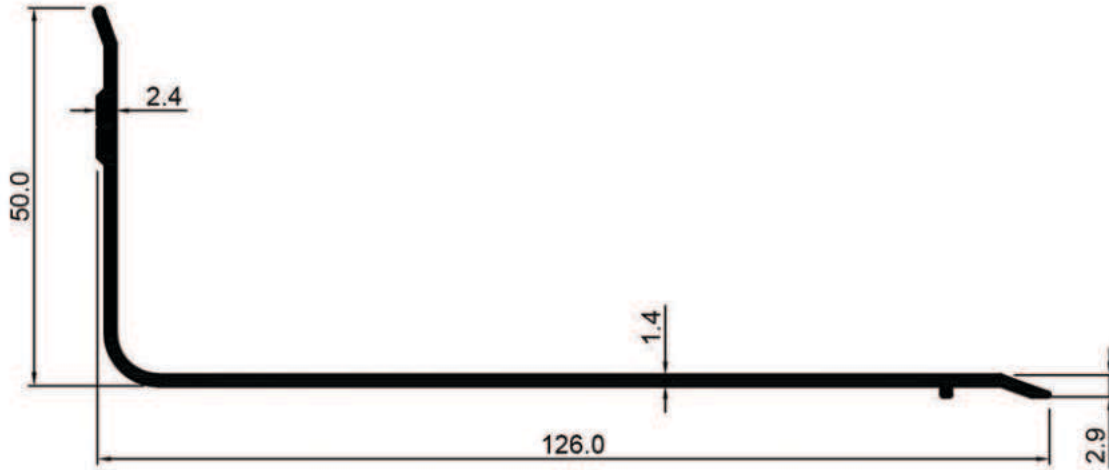

0508

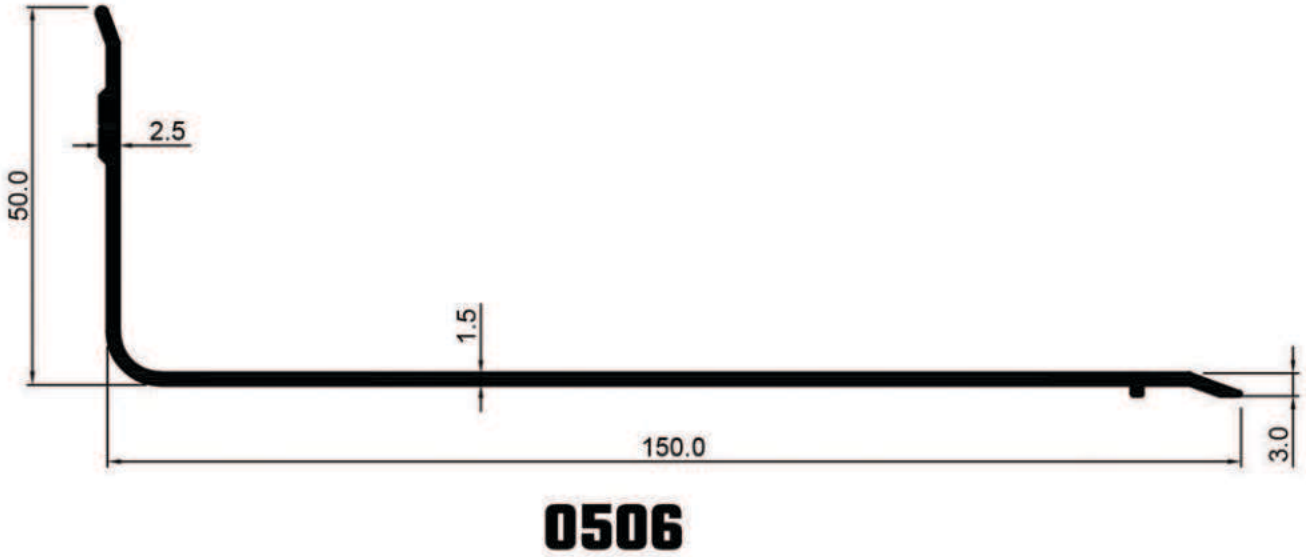
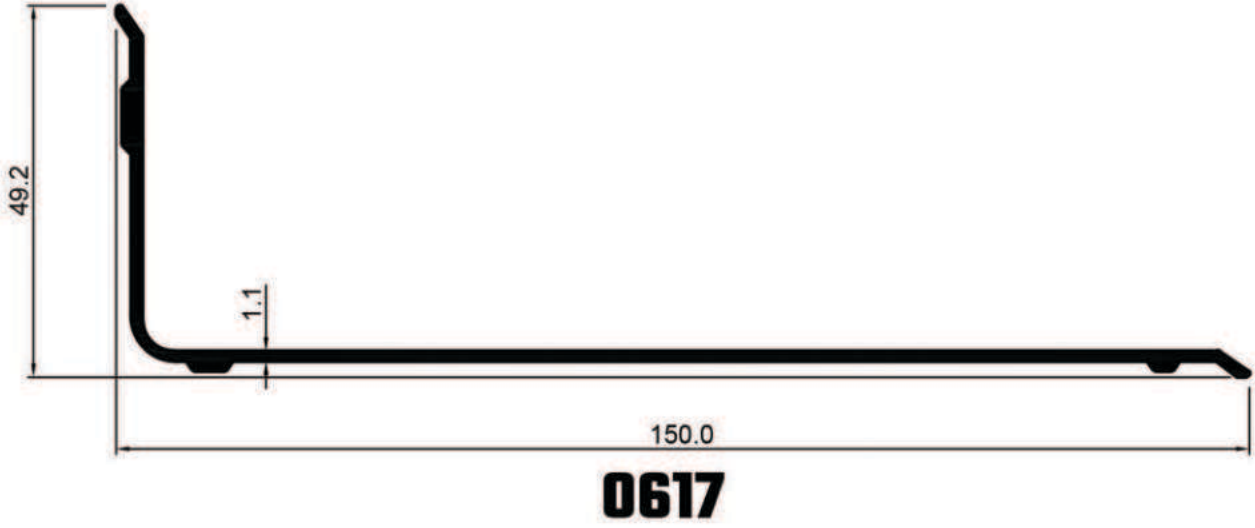

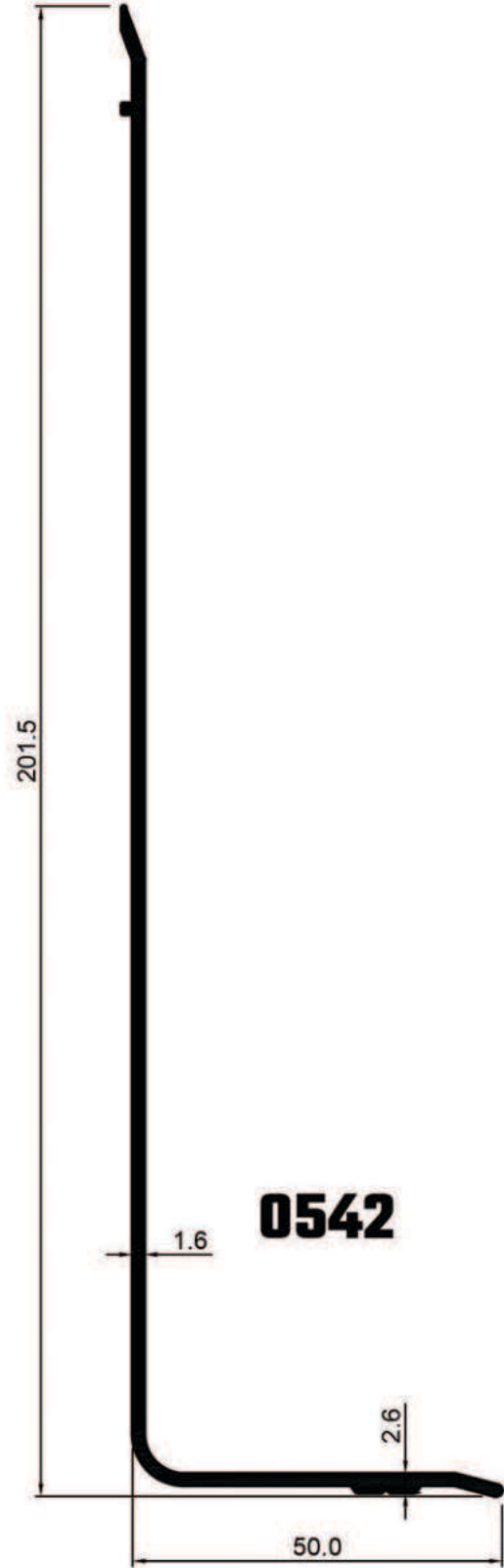
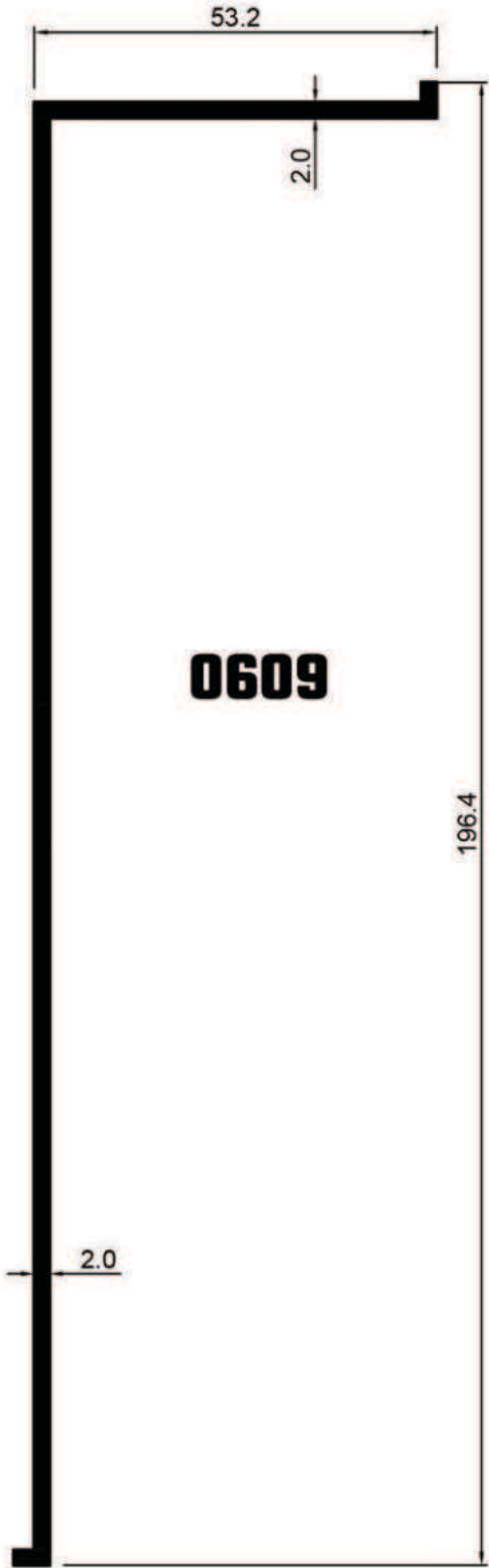

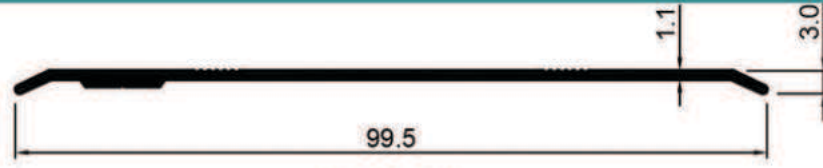

0630

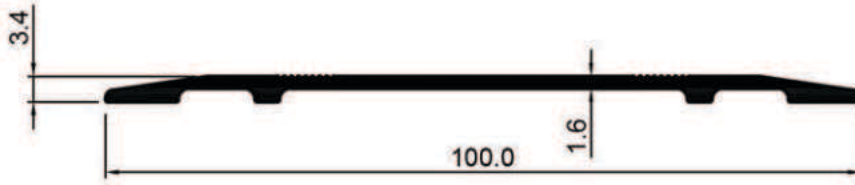

0545

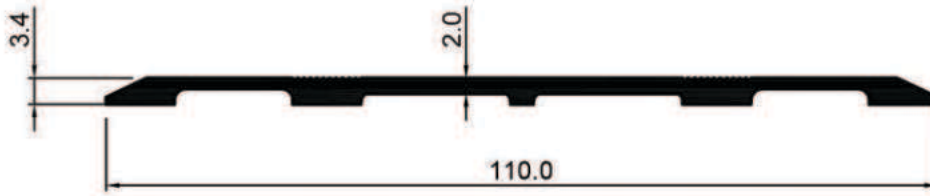

0522

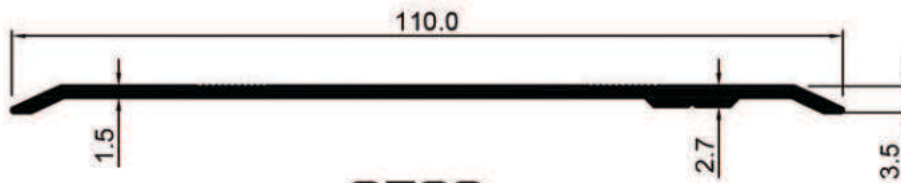

0523

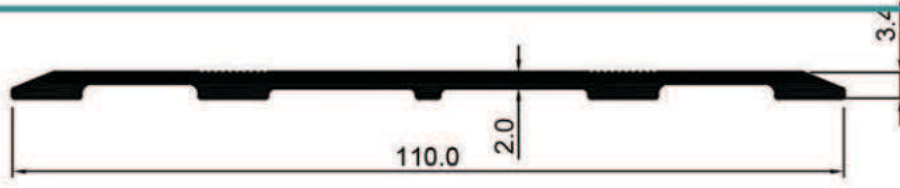

0548

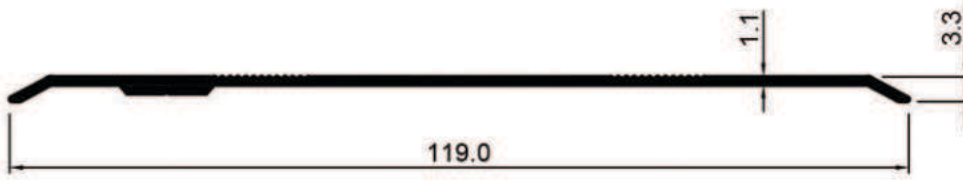

0629

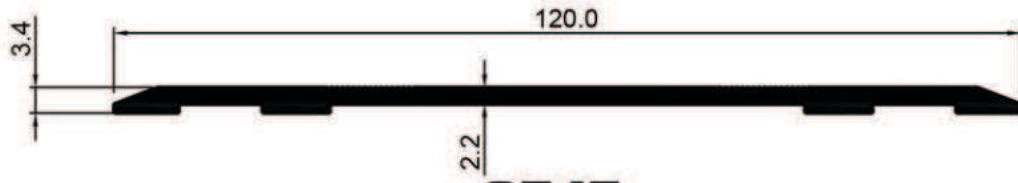

0547

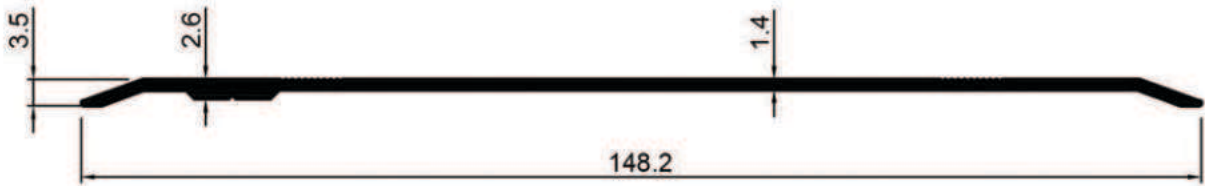

0526

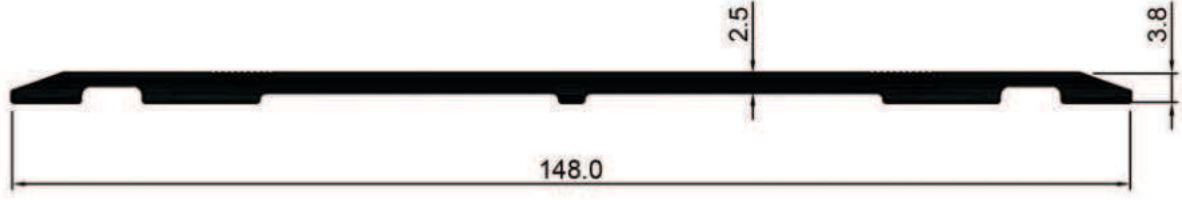

0631

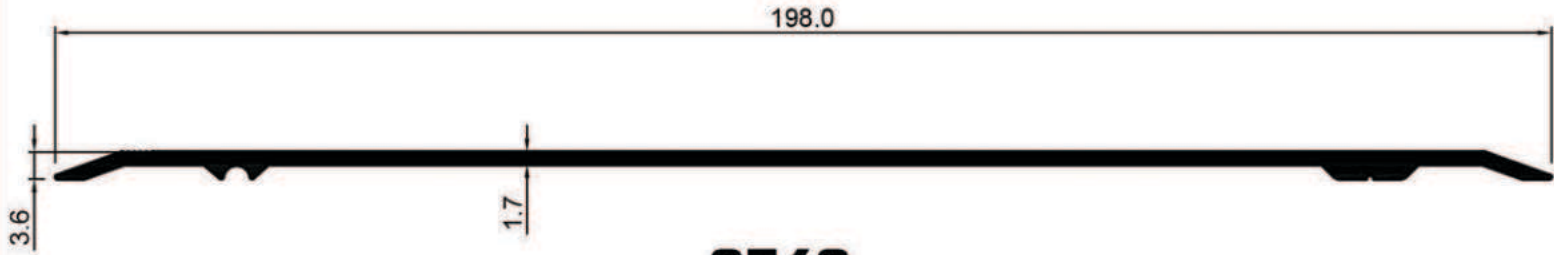

0540

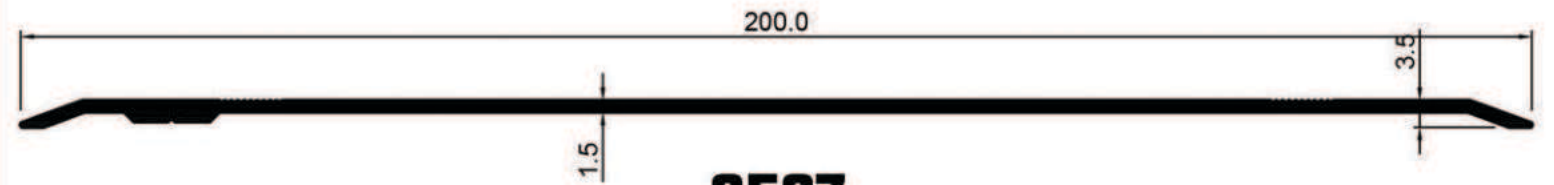

0507

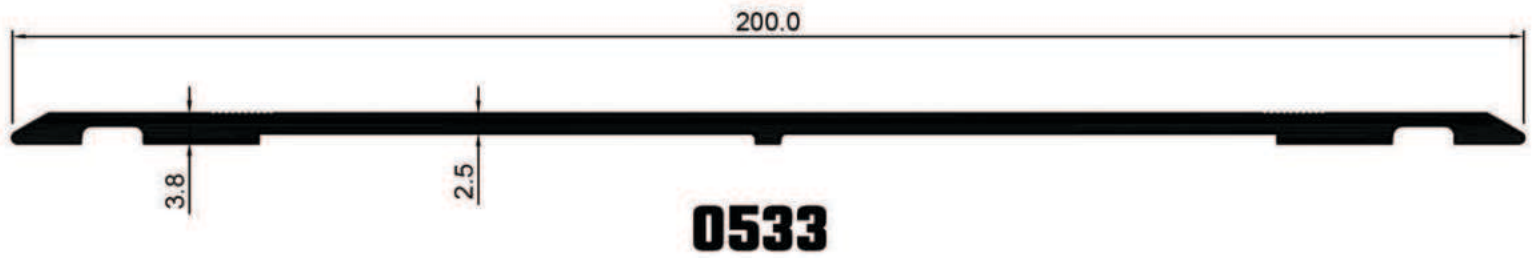
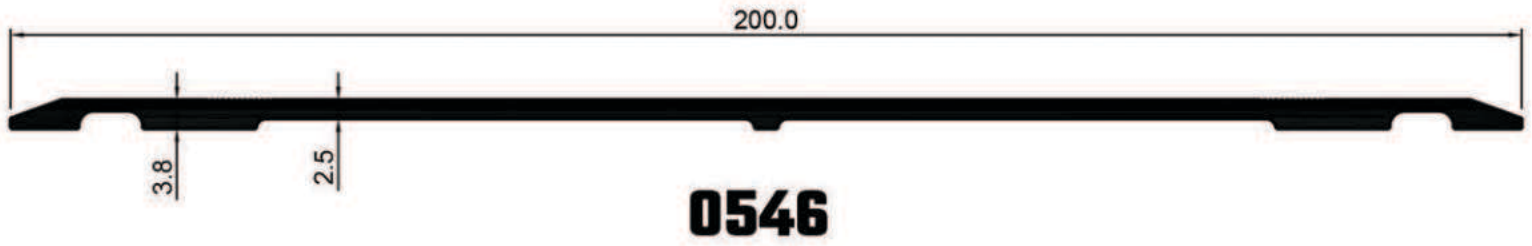
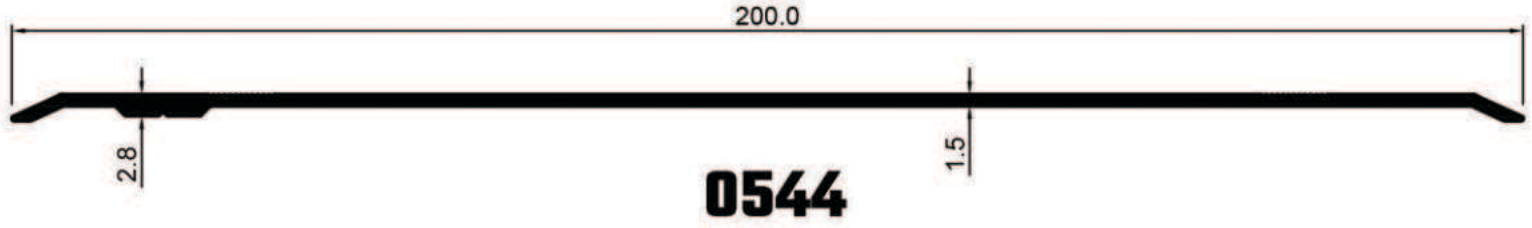

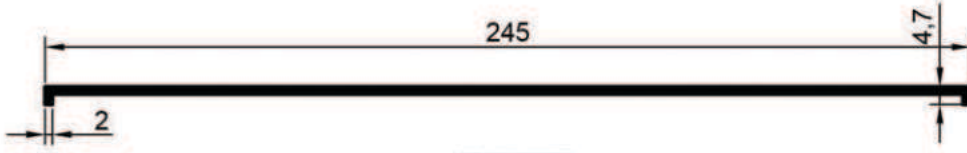

0611

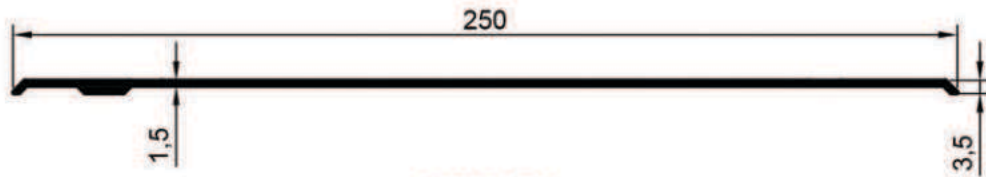

0543

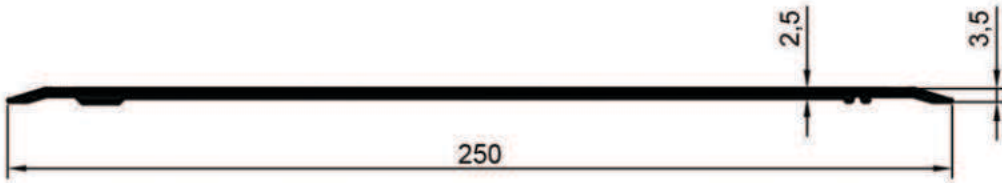

0624

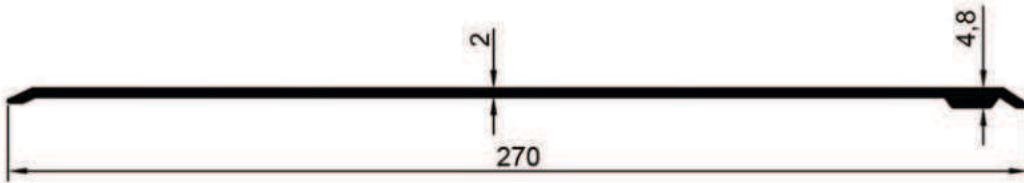

0618

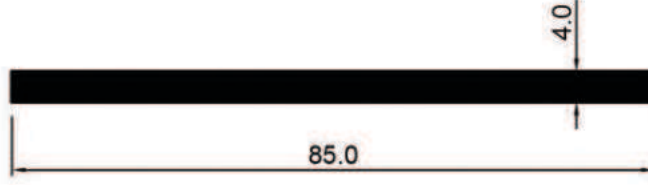

0556



0589

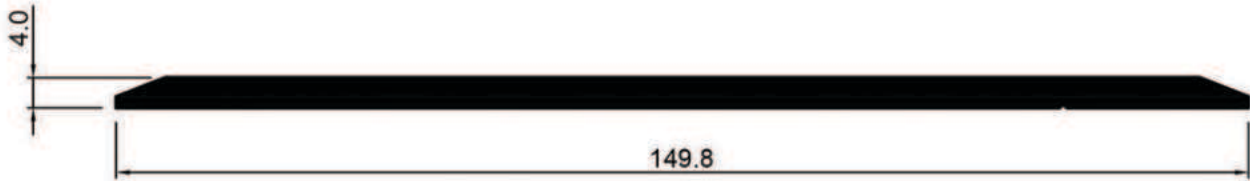

0519

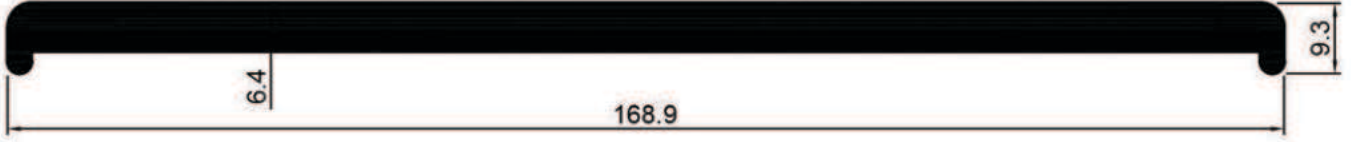

0583

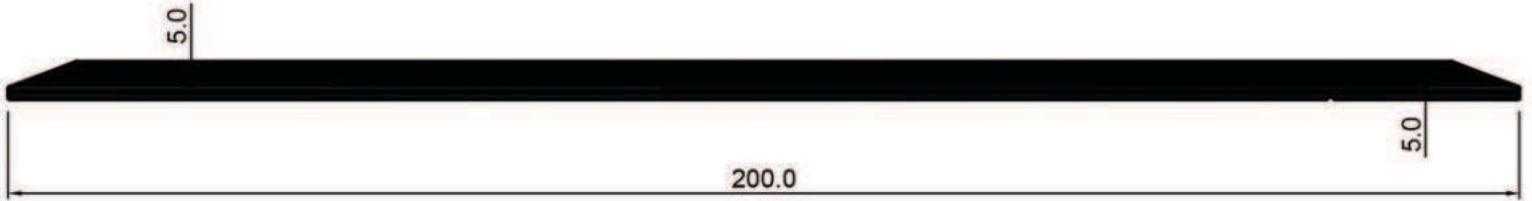

0532

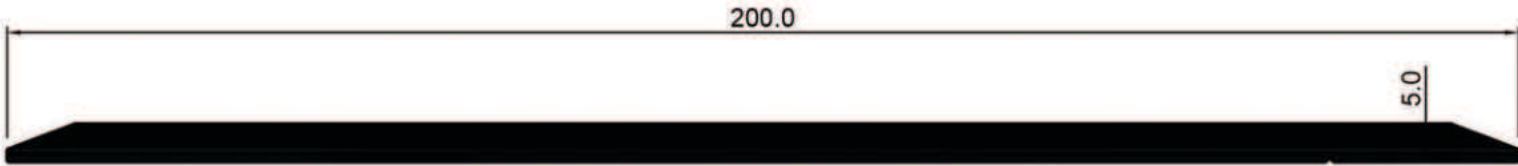

0553

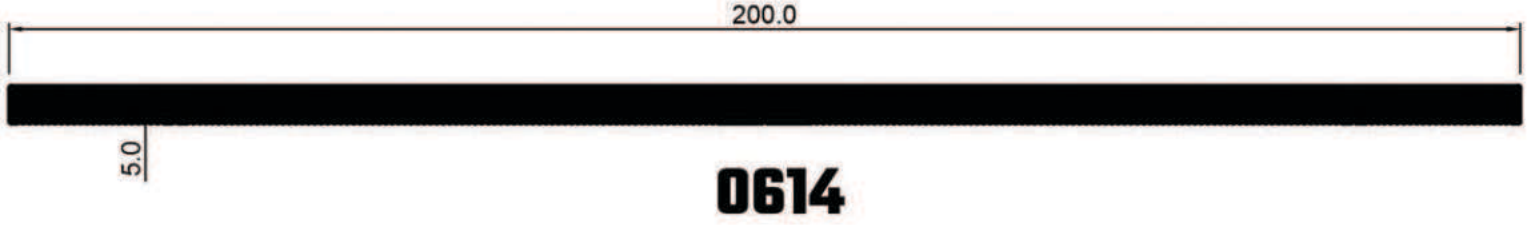



ŞEMSİYE PROFİLLERİ

UMBRELLA PROFILES

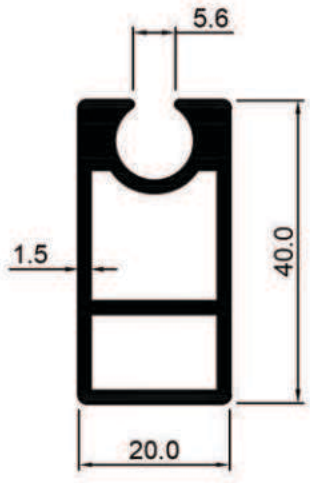

4202



4206

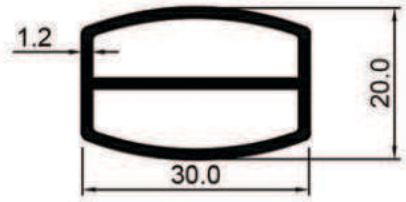

4211

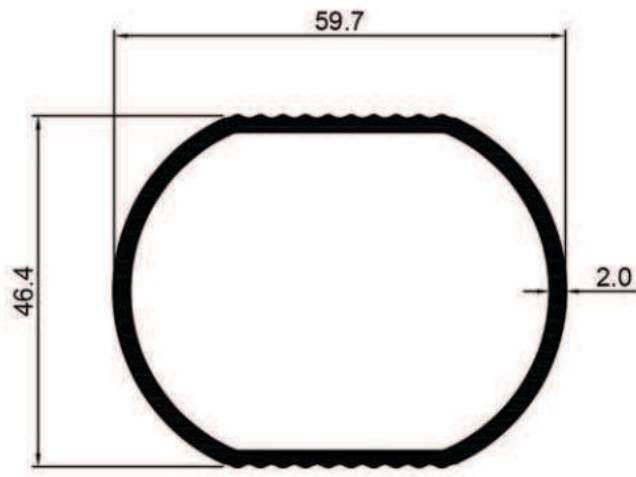

4215

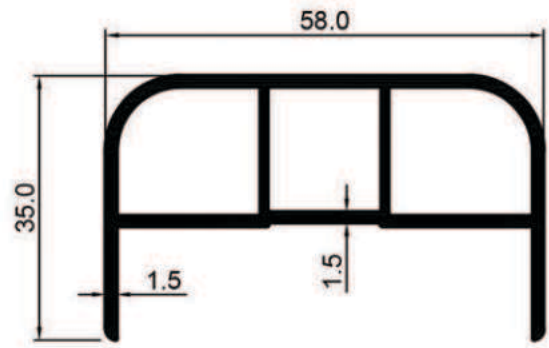

4214

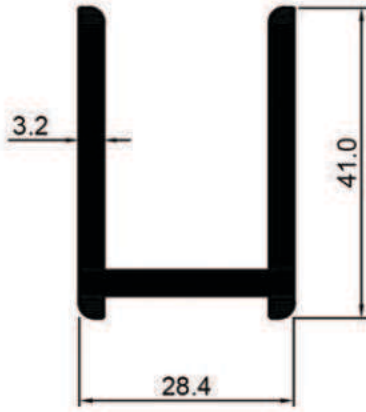

4217

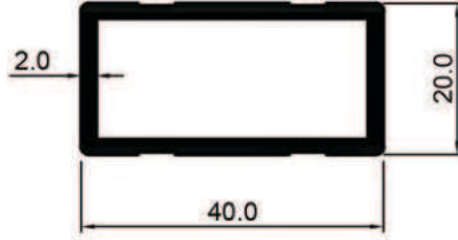

4237

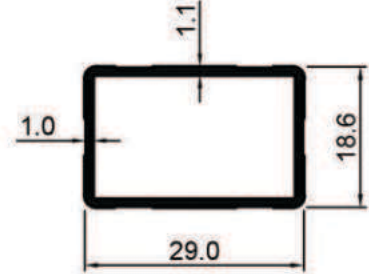

4240

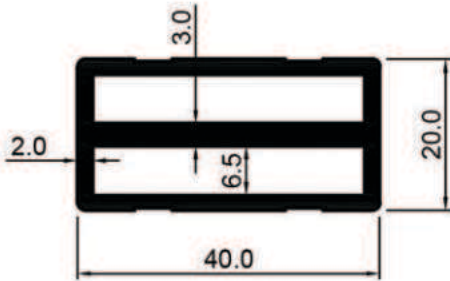

4241

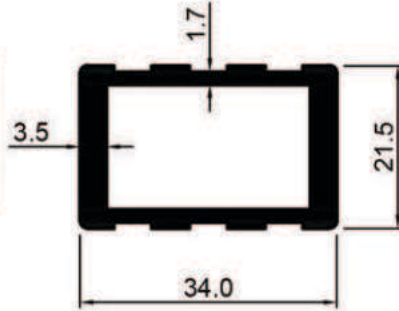

4242

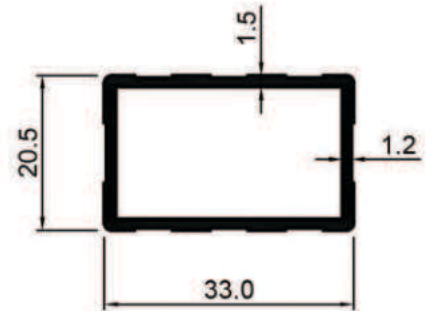

4243

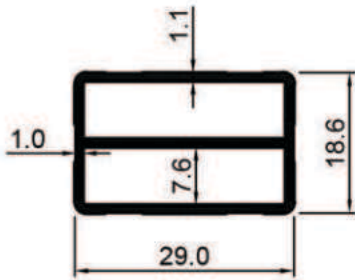

4244

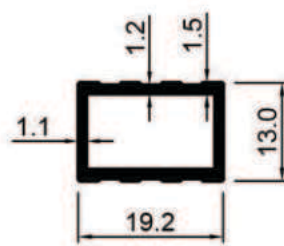

4260

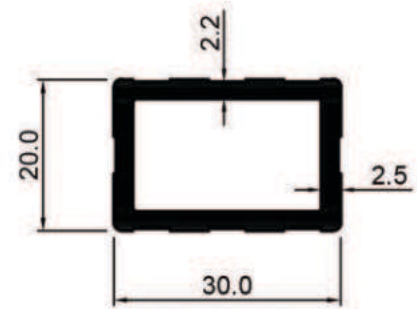

4254

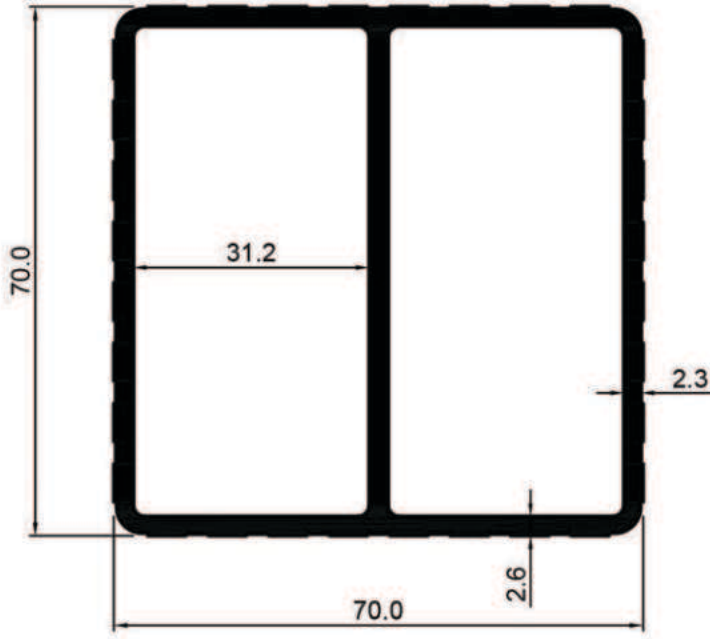

4245

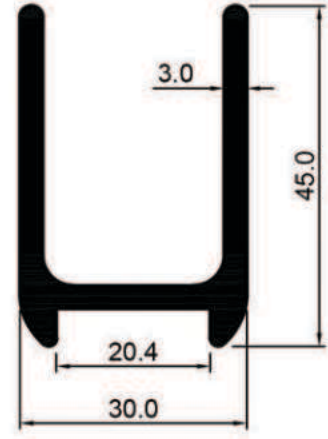

4259

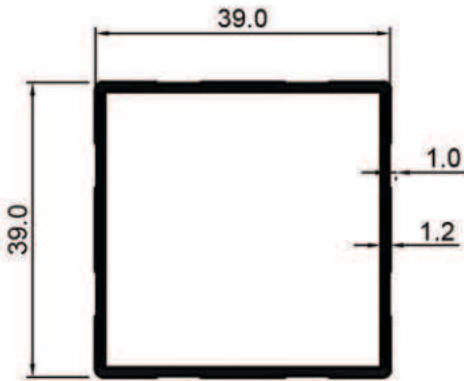

4257

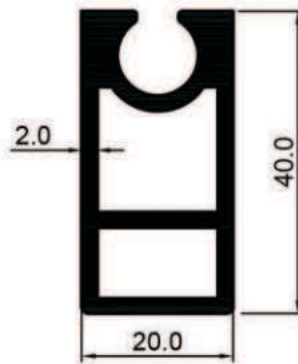

4203

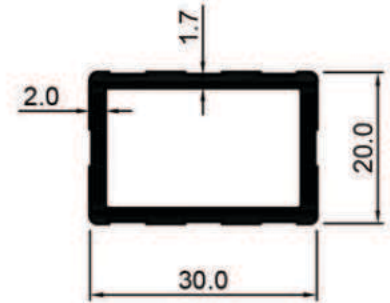

4248

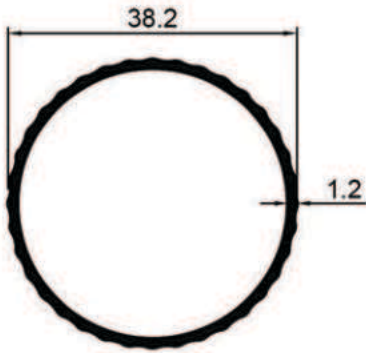

4247

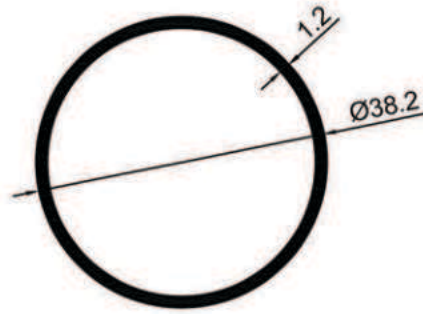

4251

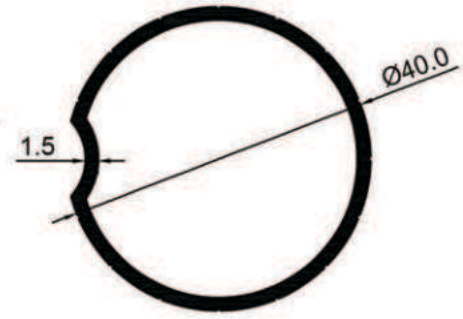

4253

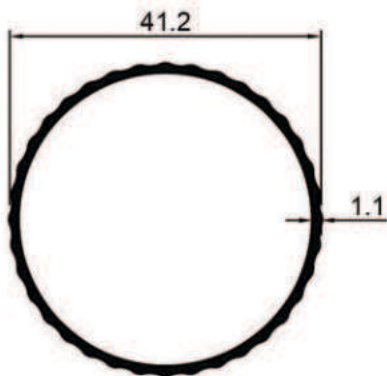

4252

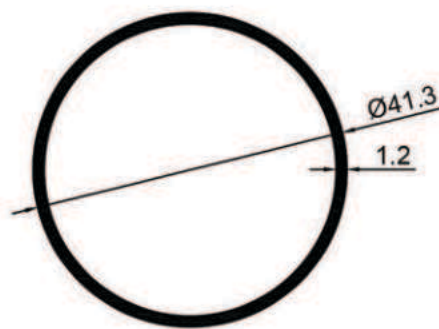

4255

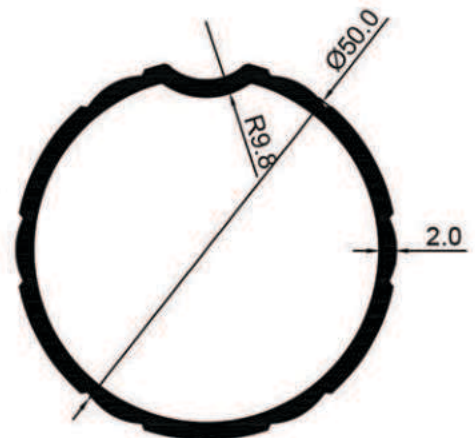

4249

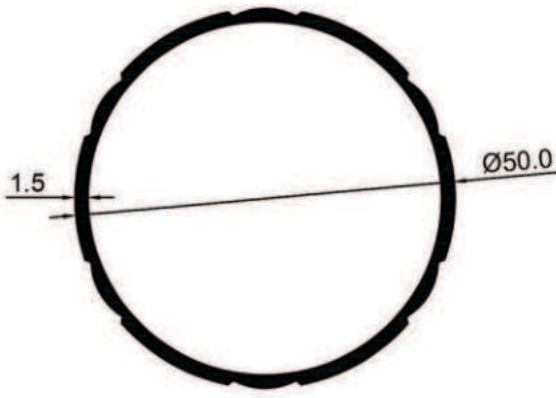

4250

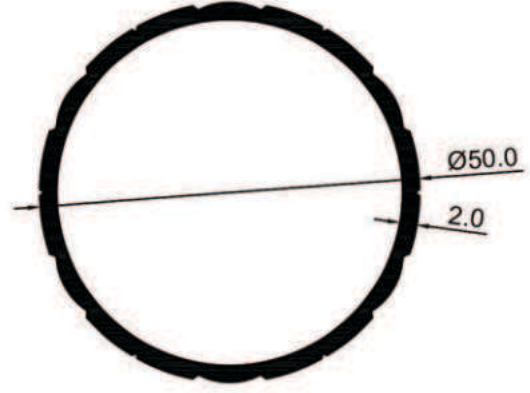

4258

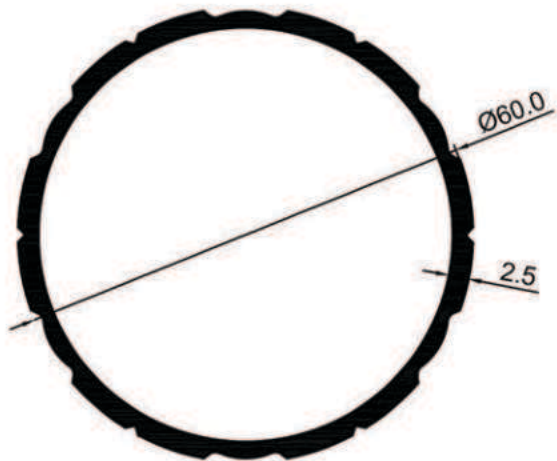

4256

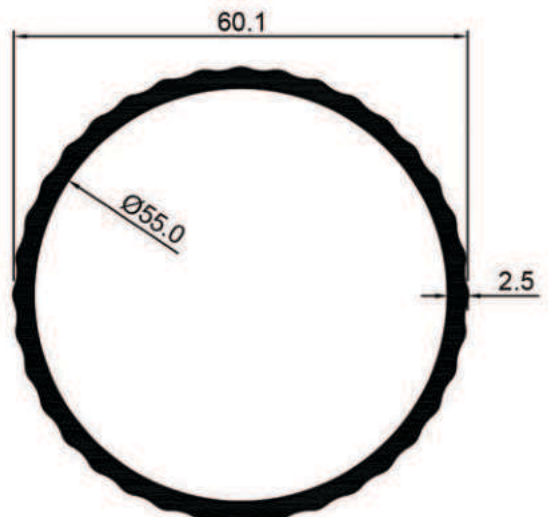

4204

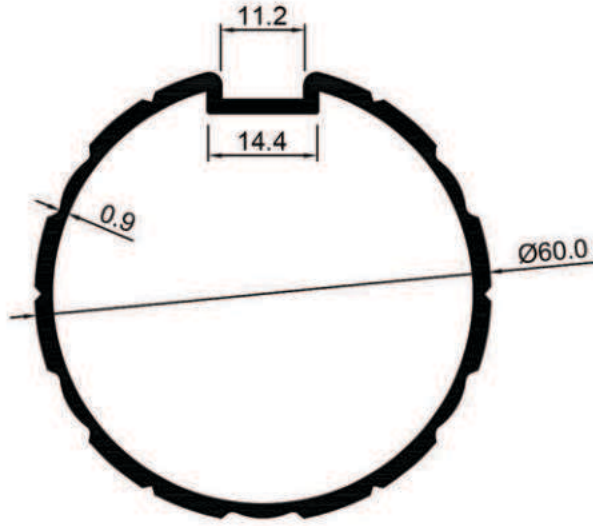

4246

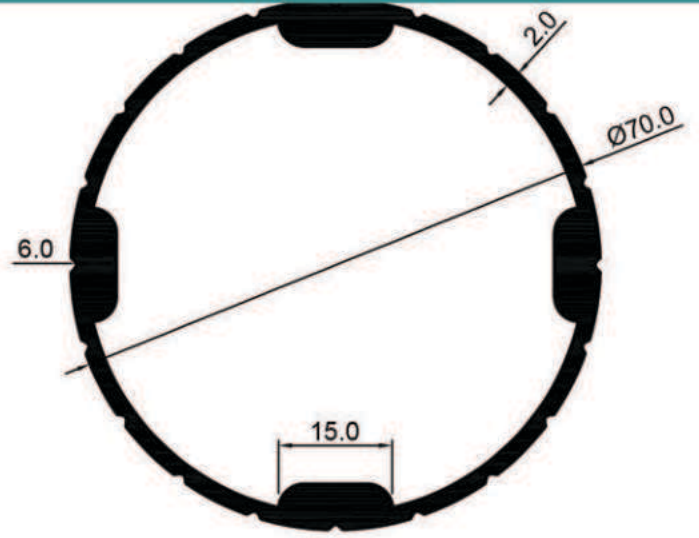

4239

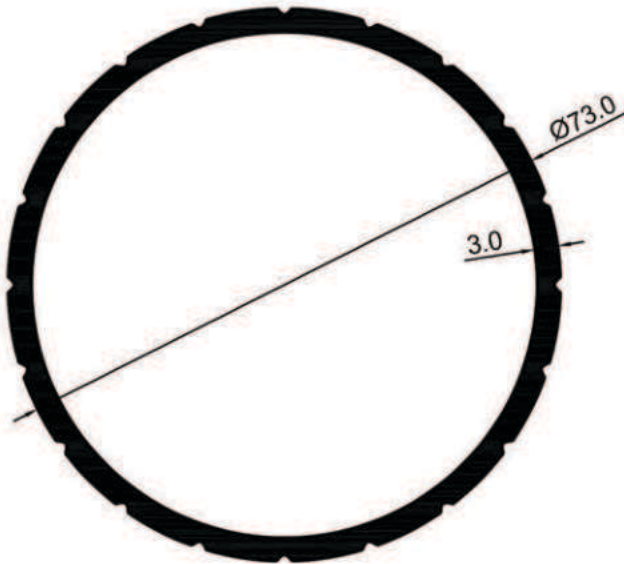

4235

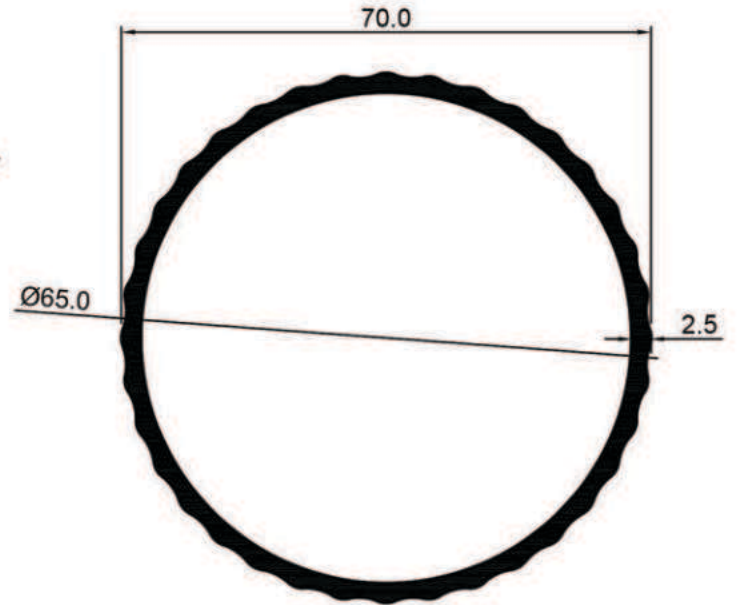

4201

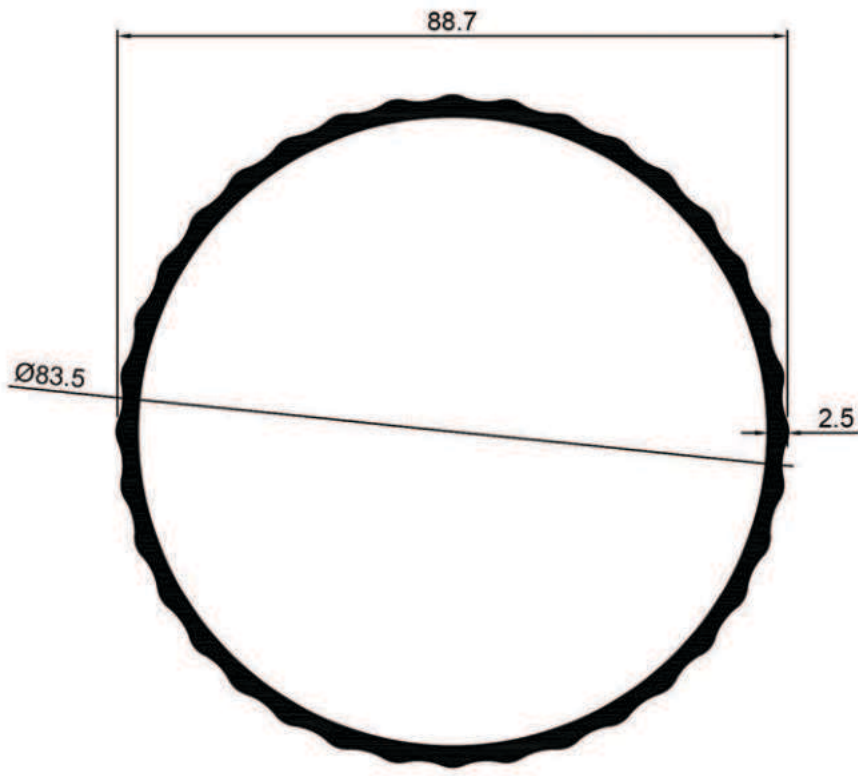

4205

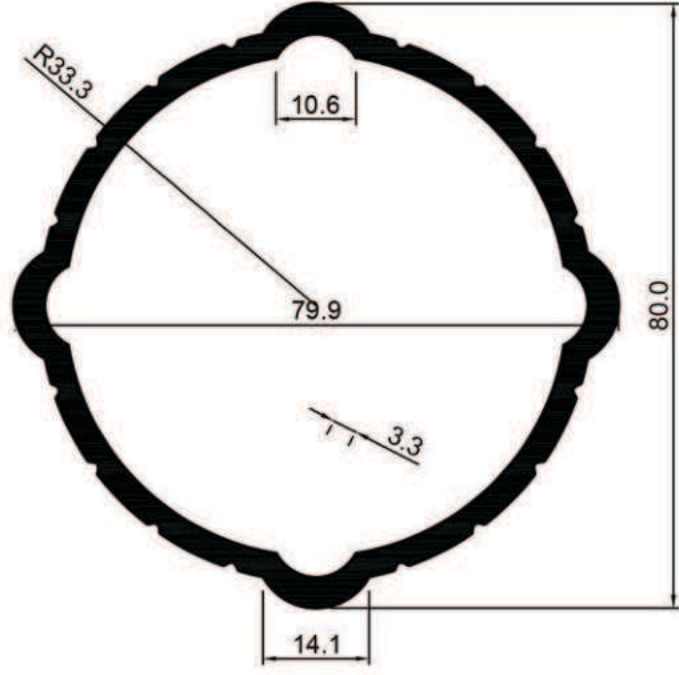

4261

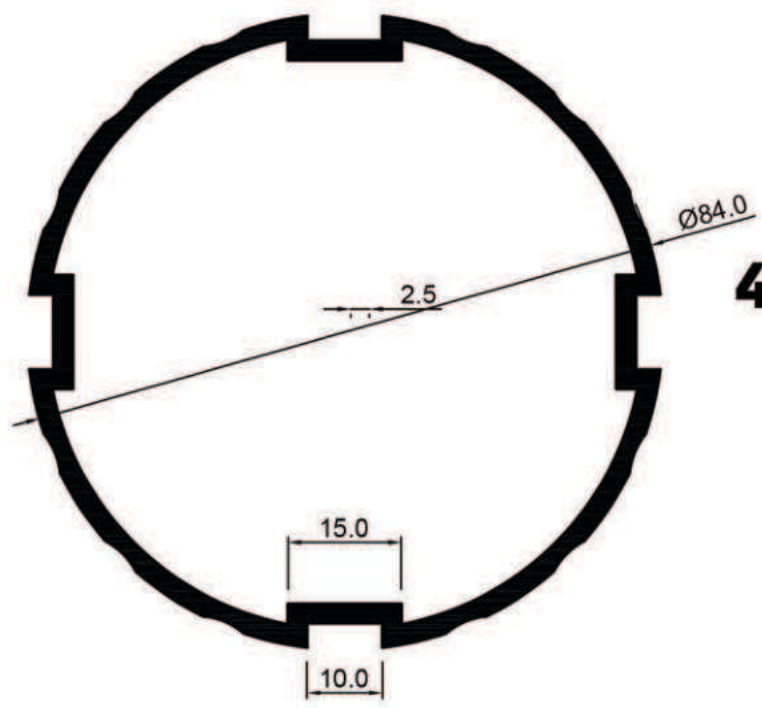

4238

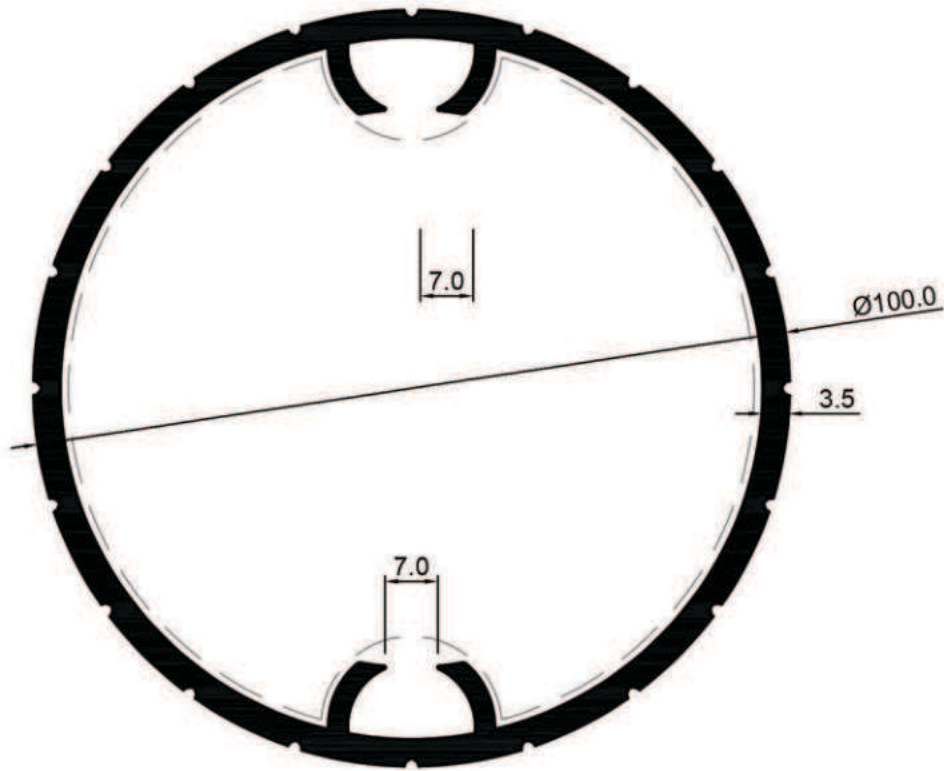

4236